

# EUROMATIC

KITCHEN AND HOUSEHOLD



## Convection Panel Heater

### INSTRUCTION MANUAL

MODEL: JCPH-1000

AFTER SALES SUPPORT  
(AU) 1300 886 649 (NZ) 0800 836 761



N13275

# Contents

<b>Important Safety Instructions</b>	<b>3</b>
<b>Product Overview</b>	<b>6</b>
<b>Getting Started</b>	<b>8</b>
<b>Operating Instructions</b>	<b>11</b>
<b>Other Useful Information</b>	<b>13</b>

# Important Safety Instructions

**Read this manual thoroughly before first use**, even if you are familiar with this type of product. The safety precautions enclosed herein reduce the risk of fire, electric shock and injury when correctly adhered to. Make sure you understand all instructions and warnings. **Keep the manual in a safe place for future reference**, along with any warranty information, your purchase receipt and the original carton. If you sell or transfer ownership of this product, pass on these instructions to the new owner.

**Always follow basic safety precautions and accident prevention measures when using an electrical appliance, including the following:**

## Electrical Safety and Cord Handling

- **Voltage:** Before plugging in the heater, make sure your outlet voltage and frequency correspond to the voltage stated on the appliance rating label.
- **Electrical circuit:** To prevent overloading a circuit, do not plug the heater into a circuit that already has other appliances working.
- **No adaptor, no extension cord:** Do not use the heater with a power board or double adaptor as this may overheat and create a fire risk. Do not use it with an extension cord because the cord may overheat and cause a risk of fire.
- **WARNING: To reduce the risk of fire, electric shock or injury:**
  - Never touch the heater with wet or damp hands or feet.
  - Do not use the heater if any part of it has become wet. Immediately call a qualified service technician to inspect the heater and replace any part of the electrical system that has been wet.
  - Never spill liquid into the heater; never immerse the cord, plug or any part of the appliance in water or any other liquid. Do not reach for an appliance that has fallen into water. Switch off and unplug immediately.
- **Damage:** Do not operate the heater with a damaged cord or plug, or after the heater malfunctions or has been dropped or damaged. If the supply cord is damaged, it must be replaced by the manufacturer or an authorised service agent in order to avoid a hazard. Contact our after sales support line to arrange an examination and/or repair.
- **Plug:** It is normal for the plug to feel warm to the touch; however, a loose fit between the AC outlet and plug may cause overheating and distortion of the plug. Contact a qualified electrician to replace a loose or worn outlet.
- **Protect the power cord:**
  - Do not twist or kink the cord or let it touch heated surfaces.
  - Do not put any stress on the cord where it connects to the product.
  - Arrange the cord away from any traffic area so no one will trip over it.
  - Do not run the cord under carpeting; do not cover it with rugs, runners etc.
  - Only operate the heater with the power cord fully unwound. Using it with the cord coiled up could cause overheating and present a hazard.

# Important Safety Instructions (Cont.)

- **After use:** Always disconnect power when the heater is not in use and before cleaning, servicing or moving the heater. To disconnect the heater, switch it off and remove the plug from outlet. When disconnecting, grip the plug, do not pull on the cord.
- **Safety switch:** Unless your home is already fitted with a residual current device (safety switch), we recommend installing an RCD with a rated residual operating current not exceeding 30mA to provide additional safety protection when using electrical appliances. See your electrician for professional advice.

## Usage Conditions and Restrictions

- **Indoor domestic use only:** This appliance is intended for indoor household use only. It is not suitable for commercial or trade use. Do not use it outdoors, on wet surfaces or near a swimming pool.
- **Space heating only:** Do not use this appliance for anything other than its intended purpose, and only use it as described in this manual. Any other use is not recommended and may cause fire, electric shock or injury.
- **No clothes drying:** Do not use this appliance as a drying rack for clothing.
- **Accessories:** The use of accessory attachments not recommended by the appliance distributor may result in fire, electric shock or personal injury.
- **Ventilation:** Only use this heater in a well ventilated area. To prevent a possible fire, do not block the space between the heater and the wall (if wall-mounted). This space is required for air intake or exhaust.
- **Keep openings clear:** To prevent a possible fire, do not insert or allow objects to enter any ventilation or exhaust openings. Do not block air intakes or exhaust openings in any manner.
- **WARNING: No external timer!** Never operate the heater on a program switch, separate timer switch or any other appliance for automatic operation, as there is a risk of fire if the heater is covered or positioned incorrectly. In order to avoid a hazard due to inadvertent resetting of the thermal cut-out, do not connect it to a circuit that is regularly switched on and off by the utility.
- **WARNING: Protect from water:** Do not use this heater in the immediate surroundings of a bath, shower or swimming pool. This appliance is not intended for use in bathrooms, laundry areas and similar indoor locations if used freestanding. Never locate this appliance where it may fall into a bathtub or otherwise become exposed to water.
- **Children:** Supervise children to ensure they do not play with the heater. Close supervision is necessary when any appliance is used by or near children.



**DANGER! Do not cover** the heater in any manner as it may overheat and become a fire risk.

# Important Safety Instructions (Cont.)

- **Usage restriction:** This appliance is not intended for use by persons (including children) with reduced physical, sensory or mental capabilities, or lack of experience and knowledge, unless they have been given supervision or instruction concerning use of the appliance by a person responsible for their safety.
- **Unattended:** Do not leave the appliance unattended while it is in use.
- **CAUTION: Hot!** Some parts of this heater can become very hot when in use. To avoid burns, do not let bare skin touch hot surfaces. Be particularly careful when children and vulnerable persons are present. Always let the heater cool down before touching it, even if it is unplugged from the power supply.
- **To ensure personal safety, do NOT install or use this heater:**
  - In front of or immediately below a power point.
  - Close to a radiant heat source.
  - Behind a door.
  - On long pile carpet or a flokati rug.
  - Near a window where it may get splashed with rain.
  - Near flammable materials or surfaces (such as furniture, curtains, pillows, bedding, papers, clothes), or near open flames. Keep flammable materials at least 1m away from the front, sides and rear of the heater.
  - In an area where petrol, paint or other flammable liquids are stored, e.g. a garage or workshop, as the heater has hot and arcing parts inside which may spark.
- **If wall-mounting the heater,** only mount it to an appropriate, sturdy wall that can support the weight of the heater. **Do not mount this heater on the ceiling!**
- **Bathroom usage:** If this heater is wall-mounted in a bathroom, it must be installed at a safe distance from the bath or shower. The heater must be installed so that a person in the bath or shower is unable to touch the pull cord control. Any power outlet in a bathroom must be located 3m from a bath or shower.
- **Ingress protection:** This heater has a ingress protection rating of IP24, which means it is protected against ingress of solid objects up to 12mm (e.g., fingers), and against water sprays from all directions.
- **Service:** This heater contains no user-serviceable parts inside. Do not attempt to open and repair the heater yourself. Other components should only be serviced by a qualified technician. All covers are intended to prevent direct access to the heating elements and must be in place when the appliance<sup>3</sup> is in use.
- **Malfunction:** In case of malfunction, disconnect the plug immediately and contact our after sales support line for advice.
- **Storage:** To avoid damaging the heater during storage or transport, keep the heater in a dry place, free from excessive vibration.
- **Improper use:** Improper use or installation may result in the risk of fire, electric shock and/or injury. We assume no liability for any eventual damages caused by improper use or incorrect handling.

# Product Overview

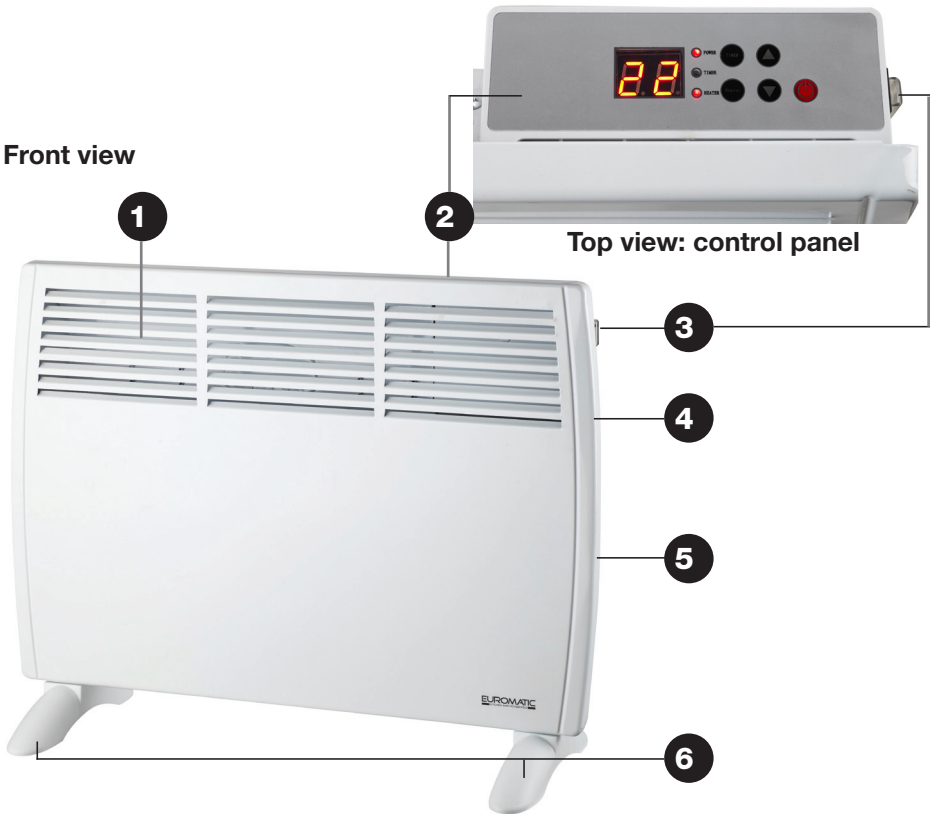

## Parts of the heater

- 1 Air Outlet
- 2 Control Panel and Display (see opposite for details)
- 3 Power Switch [ I / O ]
- 4 Power Cord and Plug
- 5 Wall-Mounting Brackets  
(4, already affixed to the back for wall-mounting)
- 6 Stand feet (2) (for freestanding use)

## Installation hardware (not shown)

- 4x Ø8 Wall Plugs and Screws (for wall-mounting)
- 6x Small Screws (for stand feet assembly)

# Product Overview (Cont.)



## Control Panel Buttons and Indicators

- A LED Display
- B Power, Timer and Heater Indicators
- C TIMER Button
- D UP ▲ Button
- E ON/OFF ⏻ Button
- F POWER Switch [ I / O ]
- G DOWN ▼ Button
- H HEATER Button

**NOTE:** Due to continued product improvement, images and illustrations in this manual may vary slightly from the product purchased. All images in this manual are for reference only.

# Getting Started

## Unpacking

- **Carton:** This product has been packaged to protect it against transportation damage. Unpack the appliance and keep the original packaging carton and materials in a safe place. It will help prevent any damage if the product needs to be transported in the future, and you can use it to store the appliance when it is not in use. In the event the carton is to be disposed of, please recycle all packaging materials where possible.
- **Plastic wrapping** can be a suffocation hazard for babies and young children, so ensure all packaging materials are out of their reach and disposed of safely.
- **Cord:** Inspect the power supply cord and plug, and all other parts of the appliance, for visual damage. Do not use the appliance if anything appears to be damaged or not working properly. **In case of damage, contact our after sales support centre using the details at the bottom of the page.**
- **Documentation:** Make sure you have read and understood all instructions and warnings in this manual. Refer to the Product Overview, on pages 6–7, to familiarise yourself with the product and identify all parts. Pay particular attention to the safety instructions on the previous pages.
- **Assembly:** Your new Convection Panel Heater can be used freestanding, with the supplied stands, or mounted on an appropriate wall using the wall-mounting kit supplied. Please choose a convenient, low position for wall-mounting where you can easily access the controls on top of the heater. Assembly instructions for both options are provided on the following pages.



# Getting Started (Cont.)

## Wall-Mounting

### IMPORTANT!

- **Only mount this heater on a structurally sound, heat-resistant wall area that is strong enough to hold the weight of the heater.** If in doubt, consult a builder. **Do not mount this heater on the ceiling!**
- The supplied installation hardware (and the instructions below) are for wall-mounting the heater onto a **masonry wall**. Please obtain expert advice if you intend to wall-mount the appliance onto any other type of wall.
- Make sure to maintain the following minimum clearances when wall-mounting the heater: 10cm above the floor and 150cm below the ceiling.
- **Do not connect the appliance to the mains power supply until completely assembled, installed and adjusted.**

To wall-mount the heater, follow the instructions below, or consult an expert.

1. If the stand feet are attached, take them off the heater. Follow the assembly instructions in reverse order (see page 10).
2. Decide where you want to position the heater on the wall and mark the positions for the wall plugs, following the illustration below.

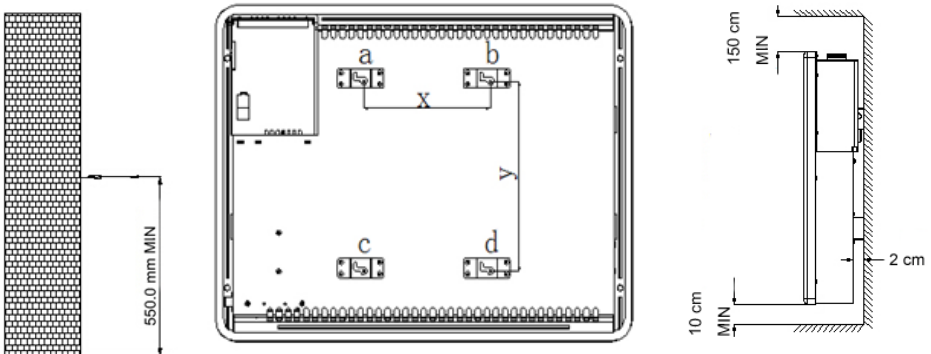

$$x = 250\text{mm} \quad y = 200\text{mm}$$

3. Drill 4 holes  $\Phi 8$  in the wall -- their diameter should be wide enough so they just tightly contain the plastic wall plugs.
4. Insert the supplied wall plugs and screws into the holes, leaving the head to protrude approximately 2–3mm.
5. Carefully position the heater over the large size of the holes in the brackets, then slide it slightly to the left and then drop it gently into place.

# Getting Started (Cont.)

## Stand Assembly (for freestanding use)

If you want to use your heater freestanding, follow the instructions below for attaching the stand feet.

- Place a soft towel on a table or benchtop and carefully place the heater upside down. Be gentle so you won't damage the heater.
- Attach a stand onto the base of the panel heater at each side. Secure the feet with the self-tapping screws provided, taking care to ensure that they are located correctly in the bottom ends of the heater side mouldings.

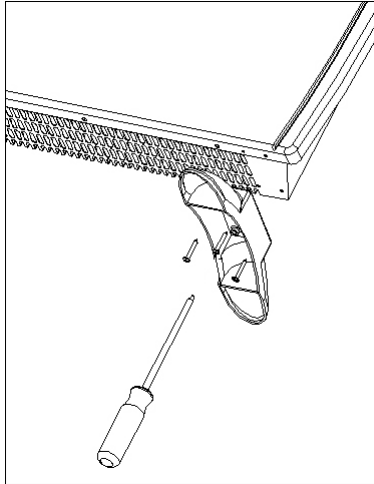

### **WARNING!**

Do not connect the heater to the power supply until it is securely mounted to the wall or until the stands are securely fitted.  
Correct installation is required for safe and reliable operation.

# Operating Instructions

## Using the Heater

Before switching on the heater for the first time, check it again to be sure it is fully assembled and did not get damaged during wall-mounting or stand assembly.

When turning your heater on for the first time it is normal for the heater to emit a 'new heater' smell, which will quickly pass. This is no cause for concern. Ensure good ventilation.



## Connection

- Make sure the POWER switch is in the OFF [ O ] position, then plug the heater into an appropriate power point and switch on power to the outlet.
- Always use a separate socket that has no other high wattage appliances connected at the same time – do not plug it into a power board or socket adaptor; do not use an extension cord.



## Switch on

- Once the plug is securely inserted, switch the heater on at the POWER switch [ I / O ] at the side of the panel. The unit will emit a short beep and the LED display will show the ambient temperature.
- Press the ON/OFF  button on the control panel to turn the heater to standby. The power indicator will light up.

## Temperature setting

- Use the UP  or DOWN  buttons to set the desired temperature (between 5°C and 50°C).
- Press the HEATER button to start heating. The heater indicator will light up and flash until the set temperature has been reached.
- The heater will then cycle on and off to maintain the set temperature.

## Timer setting

- Press the TIMER button to set the off-timer. The timer indicator will come on and [ -- ] will start flashing on the LED display.
- Use the UP  or DOWN  buttons to set the time, in 1-hour steps, after which you want the heater to stop heating. The timer range is 0–24 hours. The timer countdown will start after a few seconds.

## Turning off

- Press the ON/OFF  button to turn off the heater or cancel a setting.
- Press the POWER [ I / O ] button at the side to switch off the heater.

# Operating Instructions (Cont.)

## Extra Features

### Temperature memory

The heater has a memory function, which will remember the set temperature in case of a power failure. When the power is back on, it will continue operating to the set temperature. (Timer settings are NOT memorised and will need to be reset.)

### Safety features

- The heater has a **tip-over safety switch**, which will turn off the heater if it is knocked over or if it is not in the upright position. It will start working again as soon as the unit is placed upright.
- The unit is equipped with an **overheat protection mechanism** which shuts off the heater automatically in case of overheating. The heater will automatically turn back on when the internal temperature has dropped to a safe level. Should the overheat protection be triggered, switch off the heater at the POWER switch [ I / O ], then unplug it. Let the unit cool for 5–10 minutes, then plug it in again and operate as normal.

### IMPORTANT!

- The most common cause of overheating is deposits of dust or fluff in the appliance. Ensure these deposits are removed regularly by unplugging the appliance and vacuum cleaning air vents and grilles.
- Also make sure that the appliance can sufficiently dissipate the heat generated. This is particularly important in case the overheat protection has been triggered. Ensure there is sufficient room all around the heater, and nothing is covering or obstructing the air outlet or intake.

# Other Useful Information

## CAUTION!

Always switch off and disconnect the appliance from the power supply before attempting any maintenance or cleaning the heater.

## Troubleshooting

If your heater fails to operate, or you experience any other problem with the appliance, contact our after sales line for advice or to arrange a service. But before phoning for a service, please ensure that:

- Your heater is properly plugged in.
- The outlet is working and the circuit breaker or fuse are also working properly.

## Cleaning and Maintenance

The heater requires regular cleaning to ensure trouble-free operation.

- Before cleaning your heater, switch off the heater and allow it to cool. Disconnect the electricity supply to the appliance.
- Use a damp cloth (not wet) to wipe the exterior of the heater to remove dust and dirt. Allow some time for the heater to dry thoroughly before reconnecting it to the power supply.
- **Do not use detergents, abrasive cleaning powders or furniture polish.**
- **Do not immerse the cord, plug or heater in water or other liquid for cleaning. Do not allow water to enter the heater.**
- Use a vacuum cleaner to remove dust and fluff from around the grilles.
- To clean behind the heater, hold the heater by the sides and gently pull it up and then towards you. Clean behind the heater and then reattach it securely on the mounting brackets.

## Storage

- If you are not going to use the heater for an extended period of time, we recommend that you clean the heater and then protect it from dust.
- For long term storage, you can dismantle it from the wall (if wall-mounted) and store it in its original carton (or cover it with some material) to protect it from dust.
- Store the heater in a cool, dry place, out of children's reach.

# Other Useful Information (Cont.)

## Servicing

- If your heater requires servicing, please contact our after sales support centre using the details at the bottom of the page.
- If the power cord is damaged and needs replacing, it must be replaced by a service agent or equivalent qualified person in order to prevent a hazard.

### CAUTION!

Do not attempt to open the heater and repair it yourself. Any repairs must be carried out by a qualified technician.

## Technical Specifications

Model No	JCPH-1000
Rated Power	850–1000W
Rated Voltage	220-240V ~ 50-60Hz
Ingress Protection	IP24 -- protected against ingress of solid objects up to 12mm (e.g., fingers), and against water sprays from all directions
Dimensions (with stand)	485 (H) x 615 (W) x 240 (D) mm
Weight	4.3kg

## Compliance

This appliance has been fully tested and meets all requirements as set out by standards AS/NZS 60335.1 and AS/NZS 60335.2.30.

## Responsible Disposal

At the end of its working life, do not throw this appliance out with your household rubbish. Electrical and electronic products contain substances that can have a detrimental effect on the environment and human health if disposed of inappropriately. Observe any local regulations regarding the disposal of electrical consumer goods and dispose of it appropriately for recycling. Contact your local authorities for advice on recycling facilities in your area.



## **Warranty returns**

Should you for any reason need to return this product for a warranty claim, make sure to include all accessories with the product.

## **Product does not work?**

If you encounter problems with this product, or if it fails to perform to your expectations, make sure to contact our After Sales Support Centre on (AU) 1300 886 649 or (NZ) 0800 836 761 before returning it to the store for a refund.

Distributed by Tempo (Aust) Pty Ltd ABN 70 106 100 252  
PO BOX 6056 Frenchs Forest, Australia NSW 2086

Customer Helpline:

(AU) 1300 886 649 (NZ) 0800 836 761

Email: [info@tempo.org](mailto:info@tempo.org)

V1.0