



**LOCKLY LUX COMPACT**

**MORTISE EDITION**

**USER MANUAL**

# Table of Contents

## Section 1 - Product Highlights

1.1	Product Features	1
-----	------------------	---

## Section 2 - Product Overview

2.1	Product Overview - Outside	2
2.2	Product Overview - Inside	3
2.3	Understanding Your New Lock	4
2.4	Reset Button	5
2.5	Keypad Display Switch	5
2.6	Rebooting Your Lock	6
2.7	Low Battery	7
2.8	Changing The Battery	8

## Section 3 - Using Your Smart Lock

3.1	Configuring Access	9
3.2	Entering Programming Mode	10
3.3	Adding an Access Code	11
3.4	Deleting an Access Code	13
3.5	Checking an Access Code	15
3.6	Adding a Fingerprint	16
3.7	Fingerprint Scanning Directions	19
3.8	Fingerprint Tips & Troubleshooting	21
3.9	Deleting Stored Fingerprints	22
3.10	Adding Secure Link	23

## Section 4 - Locking and Unlocking

4.1	Locking / Unlocking with Codes	24
4.2	Locking / Unlocking using Fingerprint	25
4.3	Locking / Unlocking using App	26
4.4	Locking / Unlocking using Physical Key	27
4.5	Locking / Unlocking with Door Handle	28
4.6	Locking and Unlocking with Voice Assistant Control	29
4.8	Safe Mode	30

## Section 5 - Advanced Features

5.1	Offline Access Code (OAC)	32
-----	---------------------------	----

## Section 6 - Important Notes

6.1	Important Notes	33
-----	-----------------	----

## Section 7 - Cleaning

7.1	Cleaning	34
-----	----------	----

## Section 8 - Safety Precautions

8.1	Safety Precautions	35
-----	--------------------	----



For additional support, visit <http://lockly.com/help>  
or email [help@Lockly.com](mailto:help@Lockly.com)

# 1.1 Product Features

## **Patented Anti-Peep PIN Genie® Keypad**

Digits are randomly displayed on the key pad ensuring access codes to be undetectable to intruders after repeated use. Numbers are randomly distributed across 4 buttons, with 3 numbers in each button. Users can press any button showing their number. Location of the numbers are always different every time someone uses the keypad, making it hard for prying eyes to guess the correct code.

## **Multiple Access Codes & Monitoring**

Store up to 18 Access Codes for family, friends and guests, as well as monitor entry and exit records.

## **Advanced 3D Fingerprint Recognition**

Biometric Fingerprint Recognition protocol allows up to 99 registered fingerprints to be used and accepts only actual fingerprints - preventing lifted prints from being used.

## **Live Monitoring and Voice Control**

Through your smartphone, monitor door access from anywhere in the world and securely control who comes and goes. You can also control your Lockly® smart lock using your voice with Amazon Alexa or Google Assistant.

## **Complete Privacy**

The exterior displayed keypad can be locked and switched off using the simple ON/OFF toggle from the inside panel. The owner can prevent others trying to input the passcode from the outside and entering the home

## **Offline Access Code™ (OAC)**

The offline access code can allow owners to issue access codes, set the allowed access duration, all without Lockly® ever connecting to the internet, so in case of power outage, you can still magically and remotely issue Access Codes without any connection to the web.

## **Auto-Lock**

Users no longer have to worry about forgetting to lock the door. With Auto Lock enabled, Lockly® will automatically auto-lock the door based on your customized timing set between 5-300 seconds.

## **Backup Keys and 9V Battery Socket**

The door can be opened with physical backup keys. There is also a 9V battery connection socket for emergency power backup to access the key pad in case your smart lock runs out of battery.

## 2.1 Product Overview - Outside



## 2.2 Product Overview - Inside

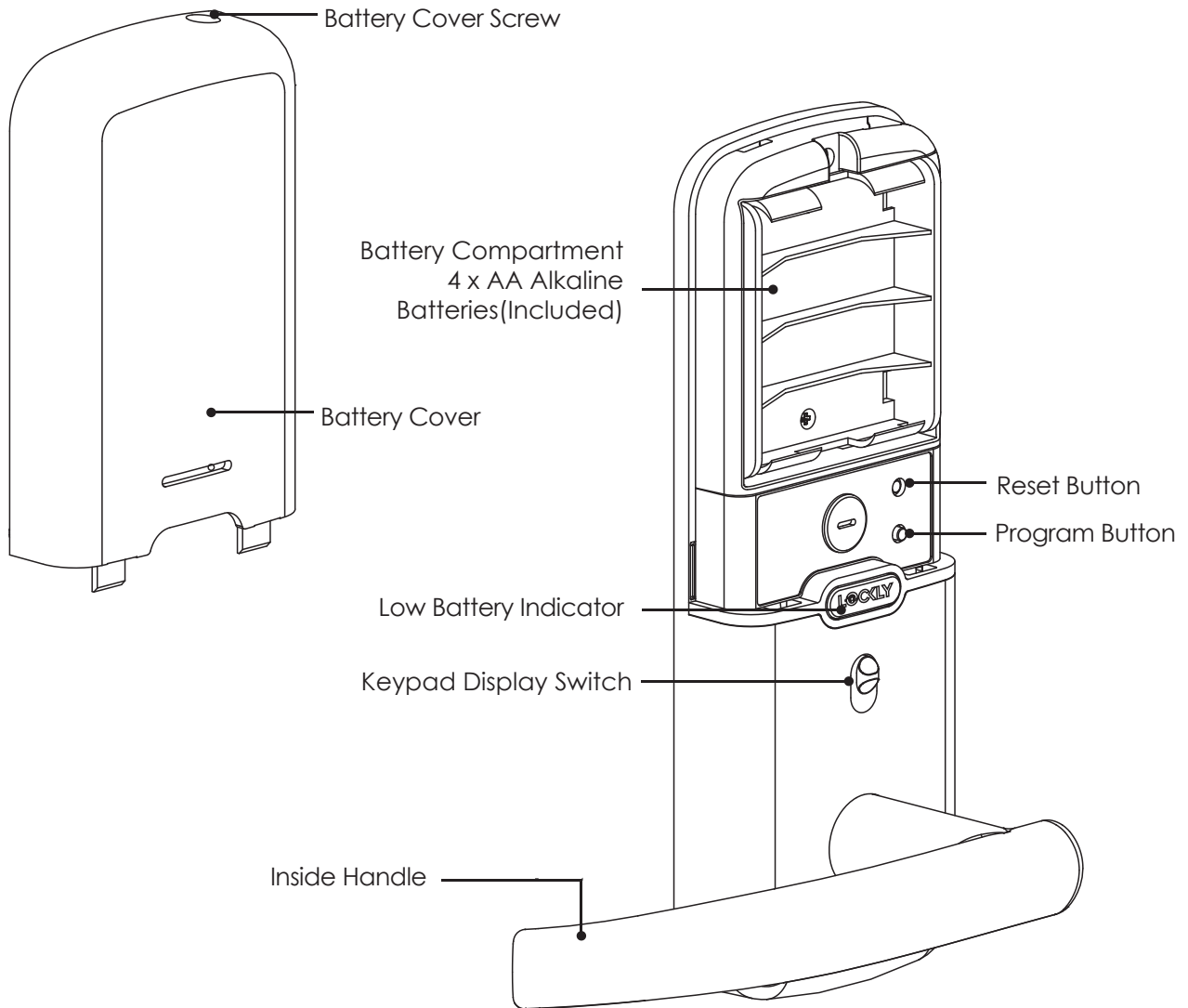

## 2.3 Understanding Your New Lock

After the installation of your new Lockly, understanding some key functions of operating your smart lock is important. The following guides will walk you through resetting a lock, adding Access Codes, deleting Access Codes, adding and deleting fingerprints, adding and deleting RFID cards, and also how to configure your OAC(Offline Access Code™).

For any questions you can always visit <https://lockly.com/help> for assistance.

Don't forget that Lockly Lux Compact works best with our iOS and Android app. Please download the app by visiting the link below.



**Scan or visit [Lockly.com/app](https://lockly.com/app)**

## 2.4 Reset Button

In order to restore the Lockly® Lux Compact to **factory default settings**, you must have your **“Activation Code”** available. The **Activation Code** can be found on the **Activation Code Card** that came with your smart lock.

After you have the **Activation Code** ready, push the **reset button** on the back panel of the Lockly® Lux Compact to perform your reset. See below to see which **Reset Process** applies for you. Once the smart lock has been reset, all the data previously stored will be deleted.

### If Paired with App

Press **Reset Button** for **one (1) second**

Open the Lockly® **smartphone app** to add your lock using the **Activation Code**

### If Never Paired

Press **Reset Button** for **three (3) seconds**

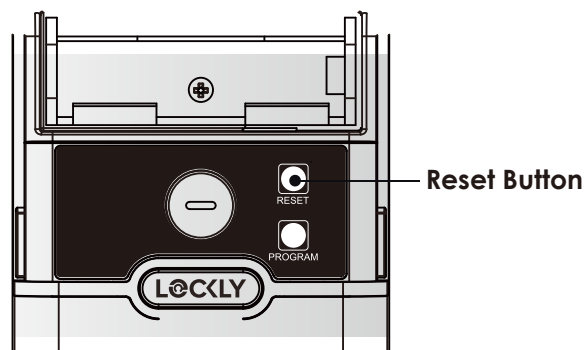

## 2.5 Keypad Display Switch

The exterior keypad screen can be locked and turned off by using the **ON/OFF** switch at the back panel (interior) of the smart lock. When it is switched off, people who are outside cannot enter any access codes to unlock the door.

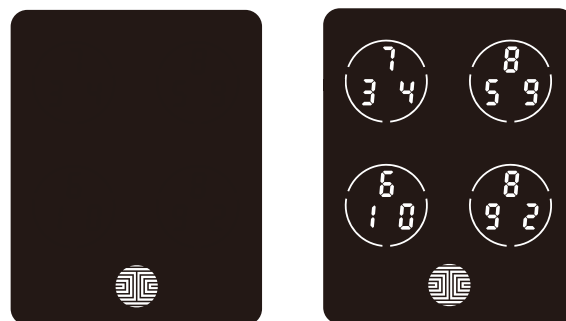

## 2.6 Rebooting Your Lock



### NOTICE

Reboot Lockly in case of dead battery or malfunction. No settings will be changed and all Access Codes will still be stored within Lockly.

Press and release the reboot button when you want to reboot the lock. Your Lockly will beep once after reboot. Only reboot when necessary.

To reboot, find the reboot button located on the bottom of the exterior side of Lockly lock. The reboot button is located in the middle of the two 9V battery backup sockets.

You will need something small such as a paperclip, to press the reboot button. Insert the paper clip and press down firmly and let go. Your screen should restart and the lock should reboot automatically.

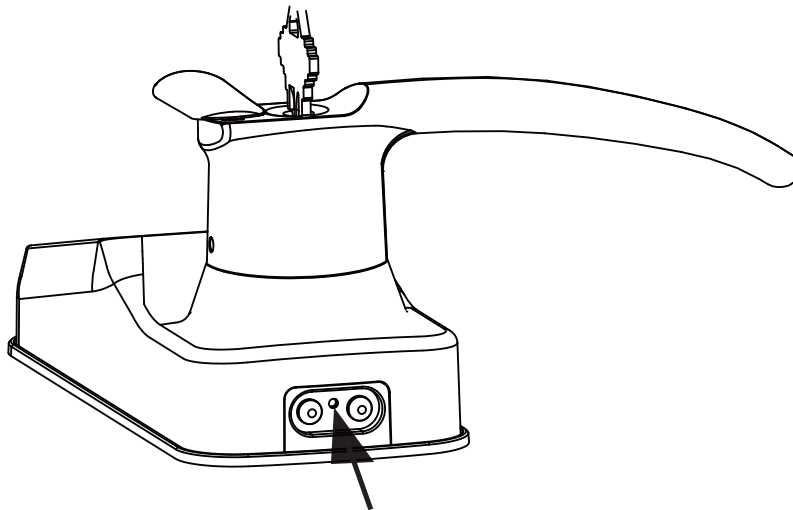

**Reboot Button**



## 2.7 Low Battery

When the battery is in seriously low condition, Lockly will make continuous beeping sounds in addition to the flashing low battery icon on the touch screen. You should replace batteries **immediately** to avoid your smart lock from **shutting down**.

When your smart lock low-battery warning alert finally dies, you will have 3 chances to unlock your smart lock either by a password, APP or fingerprint. If the unlock was successful, the low-battery warning alert will be on for 1 minute. After which, the smart lock will go to dead-battery mode and will lock auto lock in 5 seconds and the screen will display a low-battery icon.

Condition	Indicator	Solution
<b>Low Battery</b>	Battery Icon on the display keypad will light up to indicate low battery. 	Replace batteries immediately to avoid battery failure. Lockly Lux Compact can still operate up to 300 cycles in low battery condition.
<b>Dead Battery</b>	When there is no display and sounds; and screen is non-functional.	Replace batteries immediately. Supplied physical backup keys can be used to unlock the door. Alternatively, use a 9V battery as shown below to temporarily activate the lock.

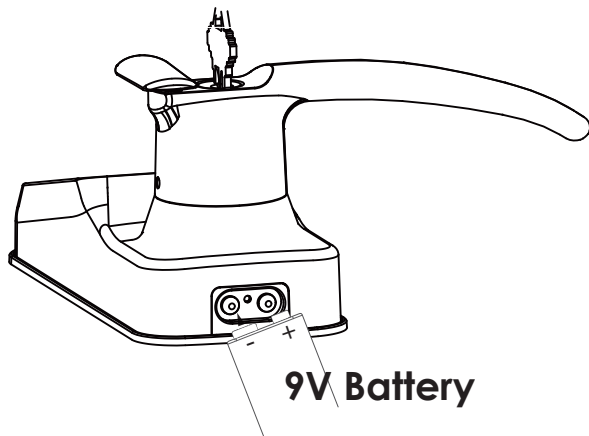

Your Lockly will automatically detect battery polarity. So hold your 9V battery lead in place against bottom of the Lockly to **temporarily** activate the screen to enter your **Access Code**. Be sure to hold the 9V battery against the contact points located at the bottom of the lock until you have successfully unlocked your door with your **Access Code**. Once unlocked, batteries should be replaced immediately.

## 2.8 Changing The Battery

Under normal use, the Lockly battery will last up to a year. Please check battery levels **regularly** and change your batteries when the low battery notification is issued. For best practice, always use **new batteries** by a major brand.

Open the battery compartment cover and insert **four (4)** new **AA alkaline** batteries as shown. Be sure to unscrew the screw located on the top of the cover first by unscrewing counter clockwise before sliding the cover up.

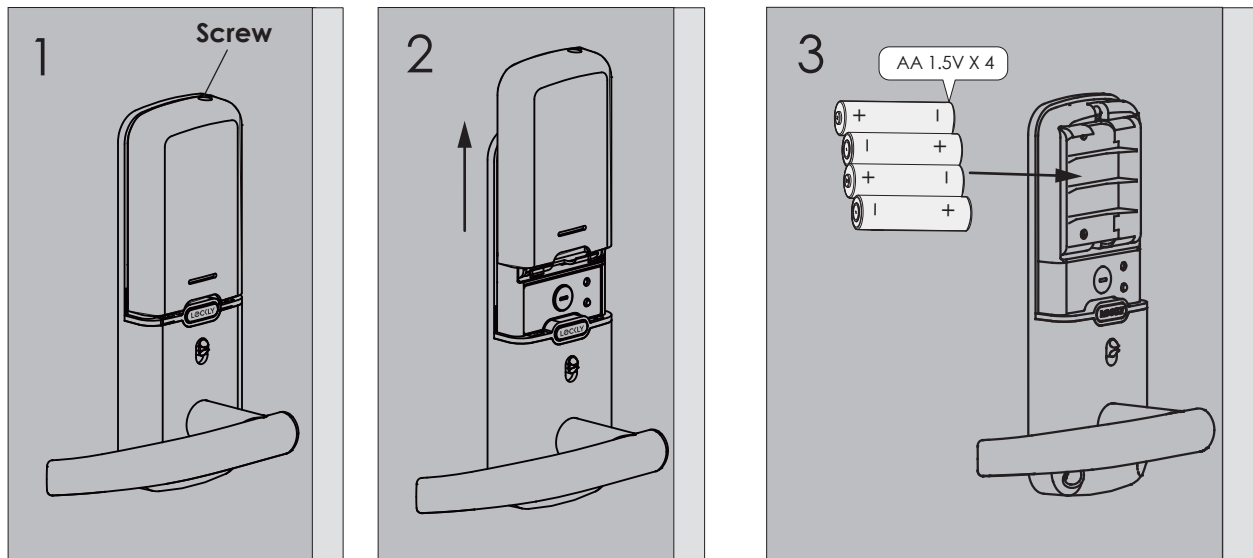

- Make sure the batteries are oriented correctly by matching the orientation displayed.
- Replacing the batteries do not reset stored **Access Codes**.
- To see a list of recommended brands, please visit <http://Lockly.com/battery>



### NOTICE

Whenever batteries are replaced, reconnecting the smart lock to your smartphone App is required.

If you have not yet downloaded the app, visit: [Lockly.com/app](http://Lockly.com/app)

## 3.1 Configuring Access



We recommend pairing your lock to your smart phone to manage your access codes. Section 3.1 - 3.9 refers to locks not paired with a smart phone. Once paired with a smart phone, the Program button will be disabled.

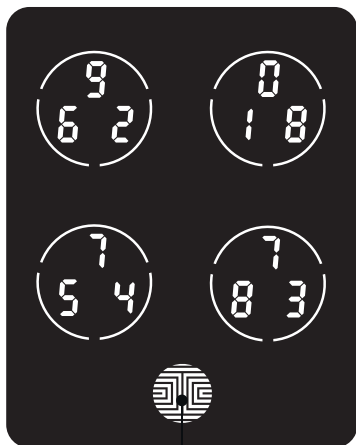

OK Button

### How to Use the Keypad

There are a total of **five (5) buttons** on the keypad as shown in the example image to the left. The numbers in each button may differ than what is shown on your device than what is displayed here.

To enter your required digit, just simply press the circle where your number is shown. You do not need to press the actual number as anywhere within the circle will suffice.

The button on the bottom is the **OK** button. You will be pressing this button when you are done entering your **Access Code**.



### NOTICE

The Default Access Code is **1 2 3 4 5 6**

Your new Lockly **Access Code** can be any combination of **6 to 8 digits**.

Once a new Access Code is entered, the **Default Access Code** of **123456** would be deleted.

A maximum of 16 sets of Access Codes can be stored for use at any given time.

To add more than 16 sets of Access Codes, you must delete an existing Access Code before adding a new code. If you're not using the APP, you can store up to 18 sets of **Access Code**.

## 3.2 Entering Programming Mode

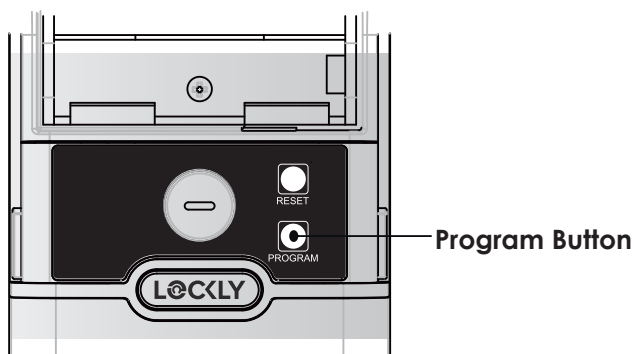

To enter **Programming Mode**, remove the battery compartment cover on the interior side of the lock to expose the **Reset** and **Program** buttons.

Simply press the **Program** button to enter programming mode.

**Note:** **Program** button will be disabled once synced to a smart phone. Configure all settings via synced smart phone. Access Codes previously added by Programming mode will be cleared.

To end **Programming Mode**, press the **Program** button anytime.

**Programming Mode** will automatically exit if the keypad is inactive for more than thirty (30) seconds.

Number	Mode
1	AD Add Access Code
2	DE Delete Access Code
3	CH View Access Code

After entering **Programming Mode**, you should see the screen as displayed to the right on your Lockly keypad. Follow the following steps to add, delete, or check your **Access Codes**.

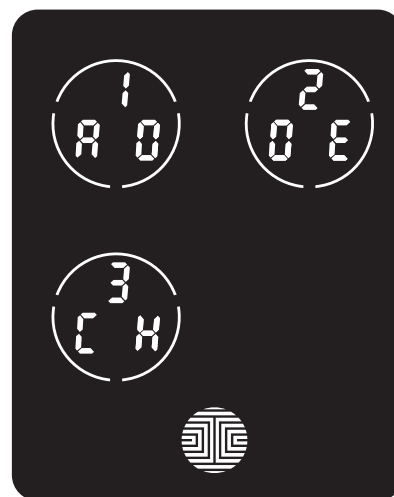

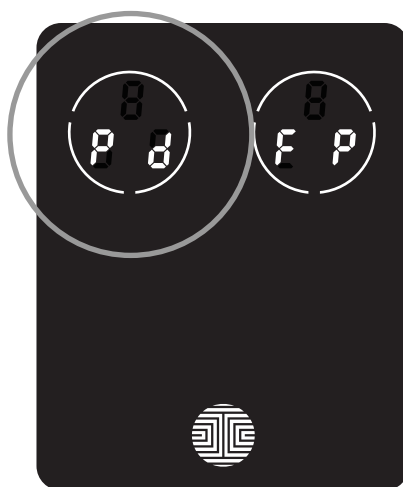
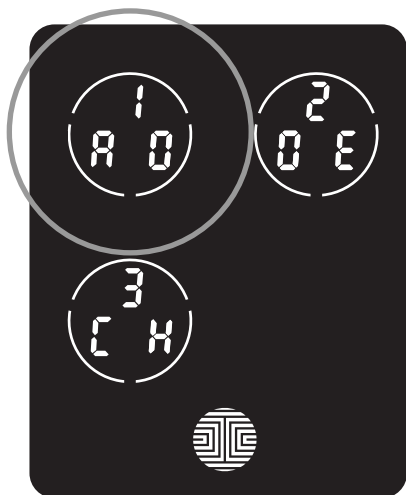

### 3.3 Adding an Access Code

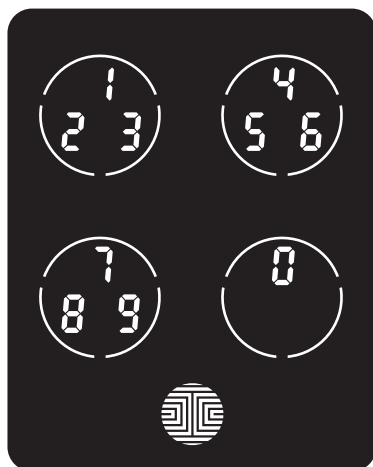

While in **Programming Mode**, select **"1AD"** to add an **Access Code**. If you are not in **Programming Mode**, please see **Section 3.2** to enter **Programming Mode**.

After pressing **"1AD"** press **"Pd"** to add an **Access Code**.



Enter your new **6 - 8 digit Access Code** and press  when you are finished. You will then re-enter the code to confirm your new **Access Code**.

Remember, just touch the digit you need within the circle around each 3 numbers. There is no need to touch the exact location of the number. For example, based on the example image to the left, if you need **"1"**, you can touch the **upper left** button or the **lower right** button. For **"6"**, you would touch the **upper right** button.

### 3.3 Adding an Access Code (Continued)

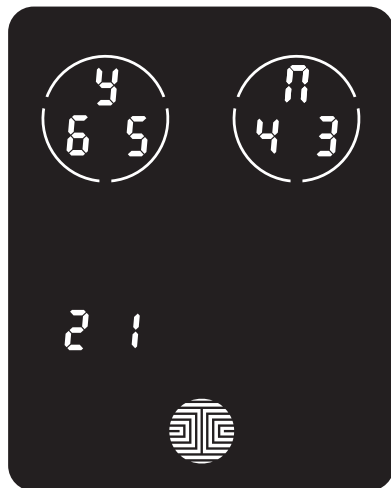

If you have successfully entered your new **Access Code** twice, you will see the new code displayed here. In this example, we chose **654321**. Press **4** to Confirm or **7** to cancel.

To exit or cancel, you can always press **7** or .

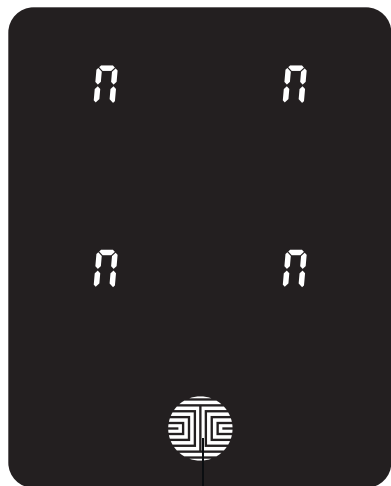

If the two (2) **Access Codes** you entered does not match, an error message will appear on the screen (As shown to the left). Press **OK** to return to the **Programming Screen** and try again. See **Section 3.3**

OK Button

## 3.4 Deleting an Access Code

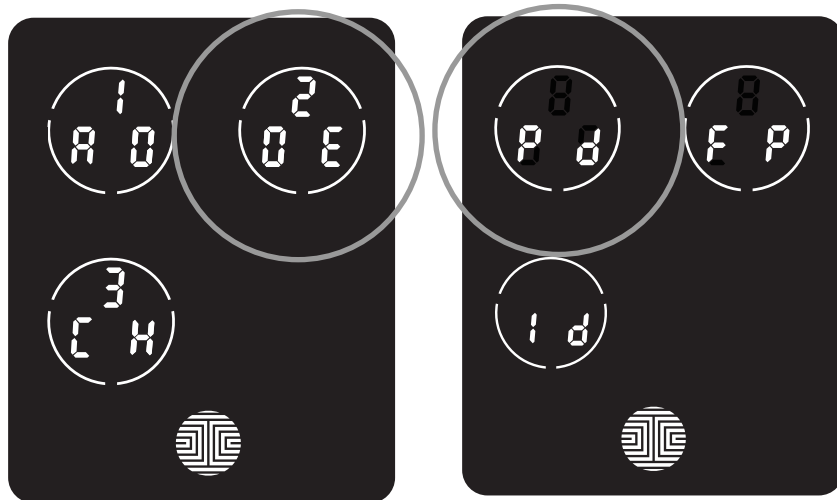

Example Only

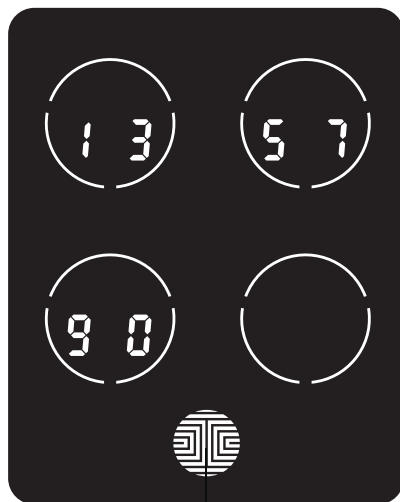

OK Button

While in **Programming Mode**, select “2DE” to delete an **Access Code**. If you are not in **Programming Mode**, please see **Section 3.2** to enter **Programming Mode**.

After pressing “2DE” press “Pd” to delete an **Access Code**.

Active **Access Codes** will then be displayed on the screen in sequence from **left to right, top to bottom**. In the example shown on the left, the **Access Code** displayed is **1 3 5 7 9 0**.

Rotate through different **Access Codes** shown by touching **any number** on the screen. If you find the **Access Code** you want to **delete**, simply **hold** the **OK** button for **2 seconds**. (**Continue on next page**)

## 3.4 Deleting an Access Code (Continued)

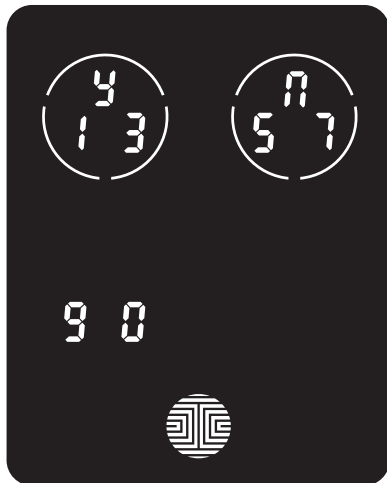

Once you have selected the **Access Code** you want to delete, Lockly will ask you to confirm deletion by showing you the **Access Code** you are deleting, in this example, **135790**.

Press **4** to delete, or **7** to cancel.

**NOTE** There are two incidents where your **Access Code** cannot be deleted.

There are no **Access Codes** set. The factory default **Access Code** cannot be deleted.

There is only one (1) **Access Code** saved in the smart lock. At least one code must be registered. Please add another **Access Code** before attempting to delete the existing code.

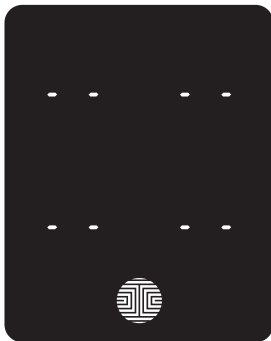

No Access Codes Set

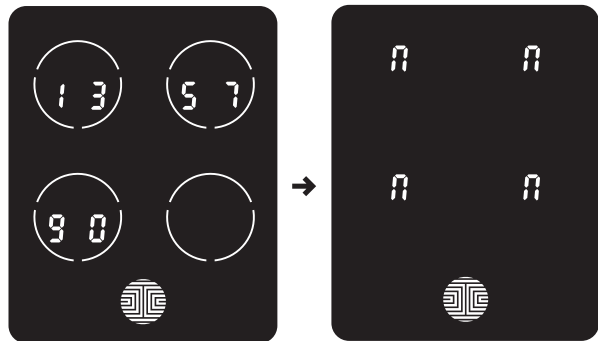

Only one Active Access Code



## 3.5 Checking the Access Codes

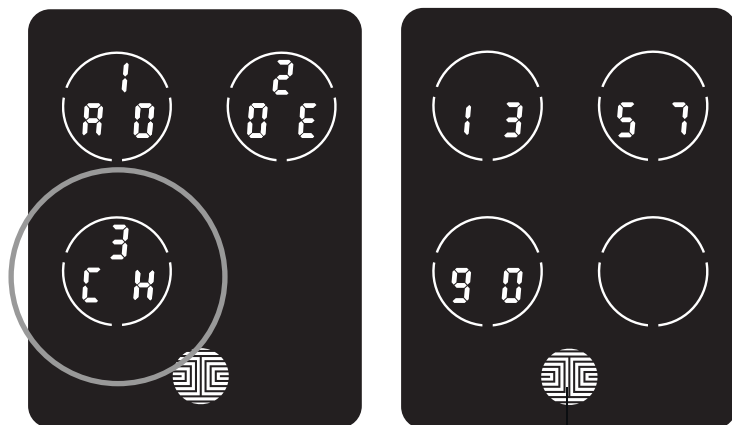

While in **Programming Mode**, select “3CH” to check registered **Access Codes**. If you are not in **Programming Mode**, please see Section 3.2 to enter **Programming Mode**.

Active **Access Codes** will then be displayed on the screen in sequence from **left to right, top to bottom**. In the example shown on the left, the **Access Code** displayed is **1 3 5 7 9 0**.

OK Button

Rotate through the different **Access Codes** by touching **any number** on the screen. To exit **Check Access Code** screen, simply press the **OK** button.

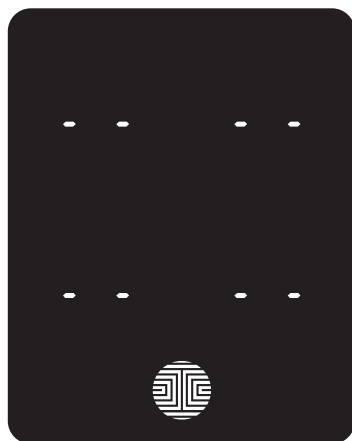

If there are no **Access Codes** registered in your smart lock, **Check Access Code** mode will be invalid. The default **Access Code** will not be shown on the display keypad, and you will see the following screen shown to the left instead.

## 3.6 Adding a Fingerprint

In this section, you will learn how to register a fingerprint to your new smart lock.

We are using an advanced biometric sensor, providing the most secure fingerprint authentication. For security reasons, Lockly will only accept fingerprint patterns that consist of cross intersection points. Patterns with no cross intersection points will not be acceptable.

Please check your fingers before registration to make sure the finger you want to register will be acceptable by our system. Otherwise, use an alternative finger to ensure successful registration.

The following examples show which types of fingerprint patterns will be acceptable. It is highly recommended to enroll at least one finger from each hand in case the hand you are using is unavailable, such as, in instances like if you are holding items in that hand or have sustained an injury.

Fingerprint Pattern with  
Cross Intersection Lines



Concentric or Parallel Pattern  
with no Cross Intersection Lines

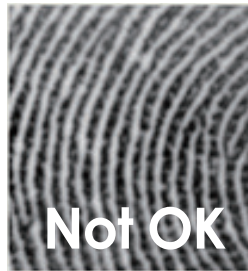

Fingerprint with Scars or Worn  
Out Ridges

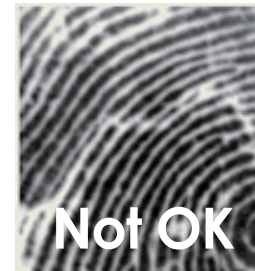

Your smart lock can register up to ninety-nine (99) fingerprints. Please read the following sections if you want to add or delete fingerprints. We recommend using your app to add fingerprints, however, the following section can show you how to add and remove fingerprints if you did not pair your lock with a smart phone.

## 3.6 Adding a Fingerprint (Continued)

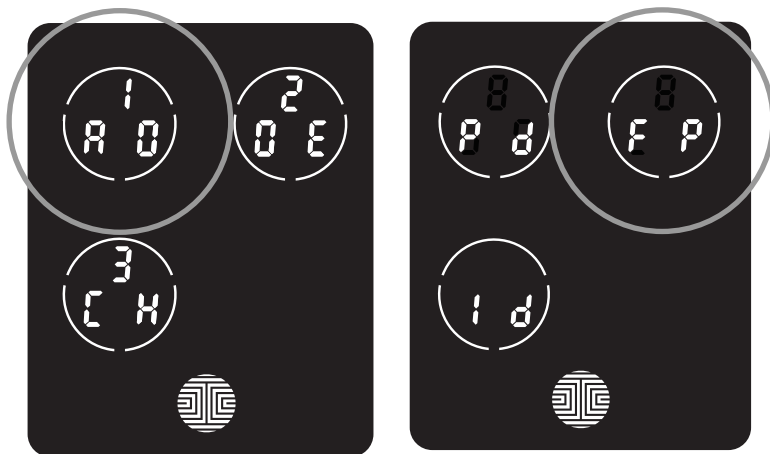

While in **Programming Mode**, select “1AD” to add an **Access Code**. If you are not in **Programming Mode**, please see **Section 3.2** to enter **Programming Mode**.

After pressing “1AD” press “FP” to register a **Fingerprint**.

Upon pressing “FP”, you will enter **Fingerprint Registration Mode** and you will see a green LED ring light up on the fingerprint panel on the exterior side of **Lockly**.

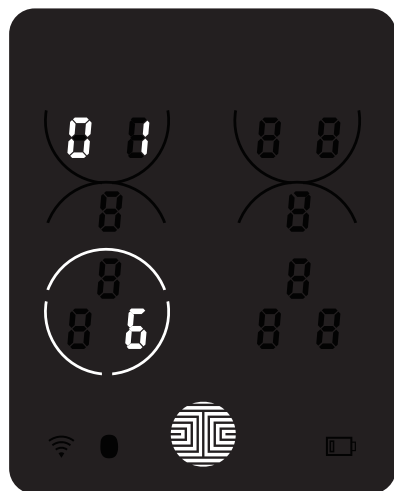

Once you're in **Fingerprint Registration Mode** you will see two numbers displayed on keypad. The top number is your **Fingerprint Registration** number, in this example to the left, “1”. The bottom number will always start with a “6”.

You must successfully scan your fingerprint six (6) times for it to properly register. Every time you scan your fingerprint, the number on the bottom will change, starting from 6 - then 5, 4, 3, 2, 1, until the fingerprint is successfully registered.

**Note:** For reference, please keep a record of your **fingerprint registration number** to distinguish whom it was registered to.

## 3.6 Adding a Fingerprint (Continued)



### NOTICE

Please make sure your fingers are clean from dirt and oils before scanning your fingerprint. Make sure the sensor is also clean by taking a soft cloth and wiping the surface.

Scan your finger by lightly placing your designated finger on the sensor until you hear a beep. Lift your finger and repeat the process slowly until the digit “6” shown on the screen becomes “1”. If you have successfully scanned and registered your fingerprint, you will hear a long beep, and the Bluetooth icon will **flash green**.

**PASS** will show on the keypad and press **OK** to exit. If you did not successfully register your fingerprint, **FAIL** will show on the keypad. If **FAIL** is displayed, press **OK** to return to the previous screen to rescan your finger.

For instructions on scanning an optimal fingerprint, please proceed to **Section 3.7**.

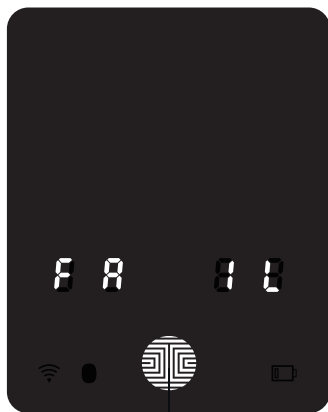

OK Button



## 3.7 Fingerprint Scanning Directions

The **fingerprint sensor** equipped in your smart lock is loaded with powerful fingerprint algorithms to extract quality features from fingers, even in poor conditions. Placing your finger on the sensor correctly helps consistency in fingerprint recognition. The following directions and tips will guide you on how to scan an optimal fingerprint image.

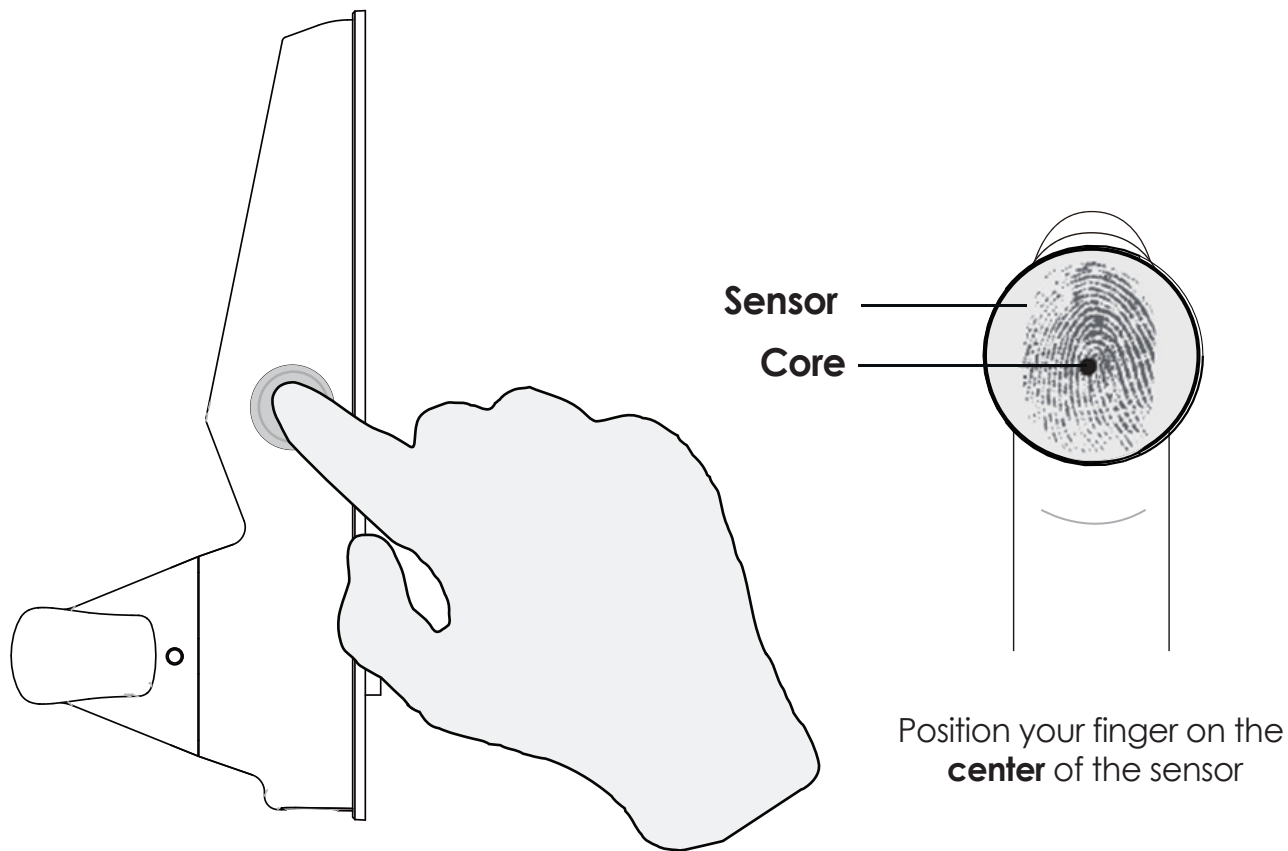

### 3.7 Fingerprint Scanning Directions (Continued)

Top View

OK

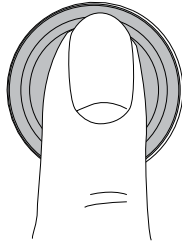

X

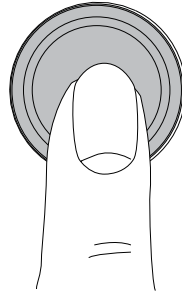

X

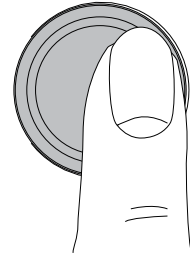

Side View

OK

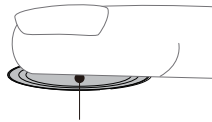

X

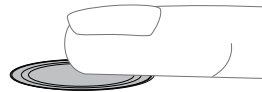

X

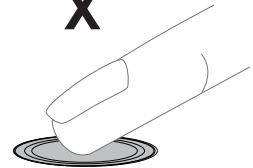

○ Correct

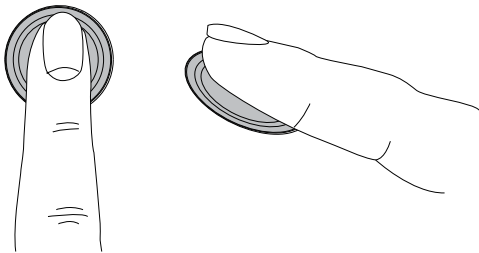

○ Incorrect

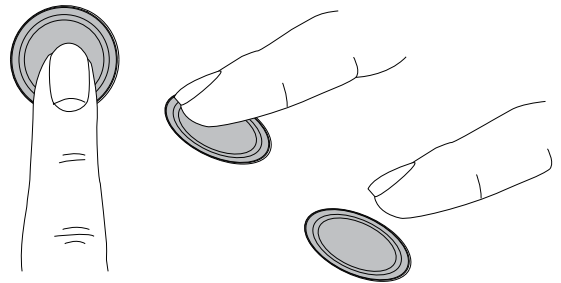

## 3.8 Fingerprint Scanning Tips & Troubleshoot

### Tips for Fingerprint Enrollment and Recognition

- Place your finger to completely cover the sensor with maximum contact surface.
- Position the center of your finger (core) to the center of the sensor.
- Hold your finger still for more than a second until you hear a beep.
- Scan a finger that is clean and free from dirt. If a finger is cracked and dry, lightly moisten the finger to improve recognition.
- Children ages 12 and under are not recommended to use fingerprint access due to the constant changes of their fingers during growth.
- Elderly with fading fingerprints may have difficulty in recognition.
- If your finger has a cut, scar, or cracked skin due to dryness, try another finger.

### Troubleshooting Fingerprints

In case of poor fingerprint conditions

- If wet - wipe excess moisture from finger before scanning
- If dry - moisturize or blow warm breath over finger before scanning
- If dirty - wipe stains and dirt off from finger before scanning
- Make sure the sensor is clean from dirt or smudges - wipe sensor with soft cloth regularly

For more troubleshooting help, visit <http://lockly.com/help>

## 3.9 Deleting Stored Fingerprints\*

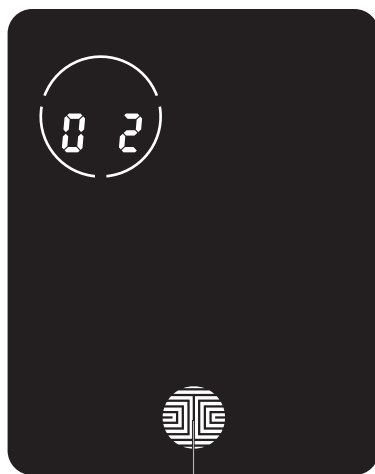
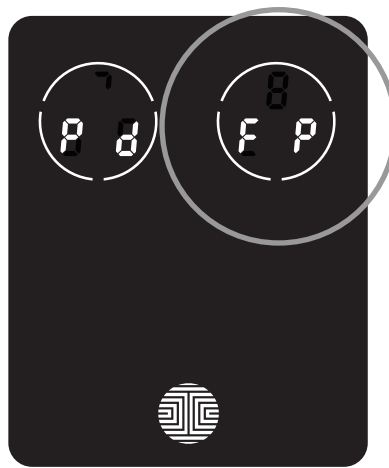
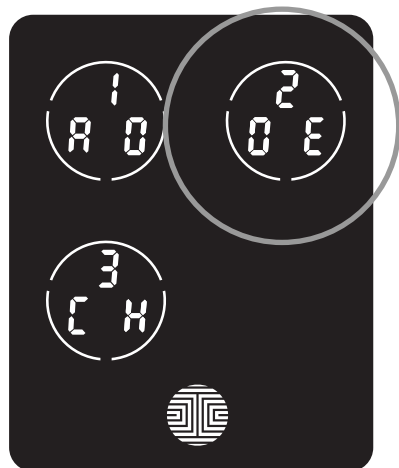

OK Button

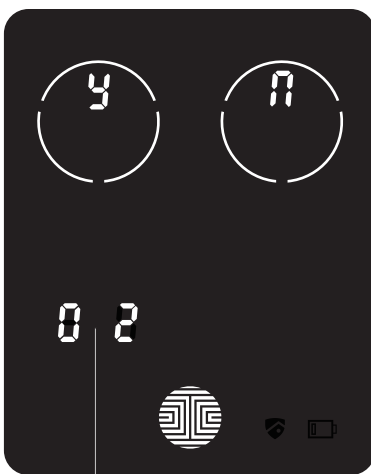

Fingerprint ID Number

While in **Programming Mode**, select **"2DE"** to delete a **Fingerprint**. If you are not in **Programming Mode**, please see **Section 3.2** to enter **Programming Mode**.

After pressing **"2DE"** to delete, press **"FP"** to delete a **fingerprint**.

Your registered **fingerprint** numbers will be displayed on the screen. Tap number to rotate to the next registered **fingerprint**. When you have found the **fingerprint ID** you want to **delete**, **press and hold** the **OK** button for **3 seconds** to **delete**. (Example shown - "02")

You will then see a confirmation page displaying **Y** and **N** with the **fingerprint** number you are deleting displayed in the **lower left**. Select **Y** to **delete** or **N** to **cancel**.

Alternatively, while on **Programming Mode**, select **2DE**, then press **FP** and place the registered **fingerprint** you want to delete on the **fingerprint** sensor. Your smart lock will identify the fingerprint and jump to confirmation page displaying **Y** and **N**. Select **Y** to **delete** or **N** to **cancel**.

\*Only works when lock is not paired with a smart phone device. If paired to a device please delete your fingerprints from the administrative device paired to your lock.



## 3.10 Adding Secure Link

Lockly® Secure Link<sup>1</sup> adds live status monitoring and voice control capabilities to your Lockly® Smart Lock. The Secure Link can be purchased and added anytime.

To set up the Lockly® Lux Compact smart lock with Secure Link Wi-Fi Hub and Door Sensors, launch the Lockly® App on your iOS or Android device. From the main menu drop down located on the upper left of the screen, select “Add a New Device” then select “Secure Link Wi-Fi Hub”. Follow the in-app instructions to set up your Secure Link.

To activate voice commands, you will need Amazon Alexa or Google Assistant. Make sure you enable the Lockly® Action for Google Assistant or the Amazon Alexa Skill before you can configure your voice to perform voice commands.

<sup>1</sup> Sold separately. Visit the link below to purchase:

**<https://lockly.com/hub>**

## 4.1 Locking/Unlocking with Access Codes

Lockly Smart Lock can be unlocked using multiple ways - via your stored Access Code, registered fingerprint, smartphone with Bluetooth, the physical key supplied with your lock, or voice (with Secure Link Wi-Fi Hub installed)

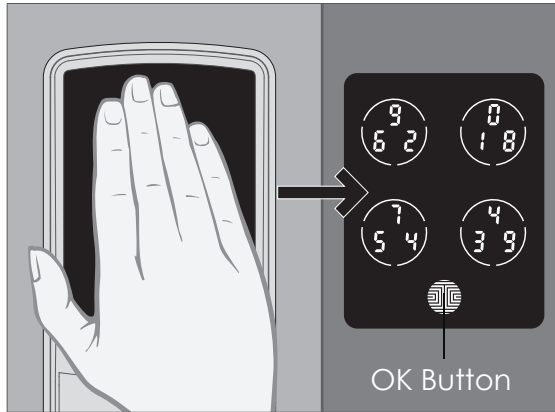

Slide your hand across the screen to activate the keypad.

Enter your 6 to 8 digit Access Code followed by the OK button. Press OK anytime to reset if you entered the wrong digit.

If the Access Code entered is correct, the door will unlock. If the Access Code entered is incorrect, Lockly will beep twice.



Three consecutive wrong attempts will put Lockly in "Safe Mode".  
(See Section 4.5)

Lock your Lockly by pressing the OK Button or by brushing your hand across the screen anytime when the door is closed. The smart lock will also auto-lock after unlocking based on your set auto-lock settings.

You may toggle between two types of keypad displays to enter your Access Code. The fixed digit version and the PIN Genie™ version (Recommended). Press and hold the OK Button for 3 seconds to toggle back and forth between the two keypads.

(Sample display shown only)

Hold OK (3 sec)

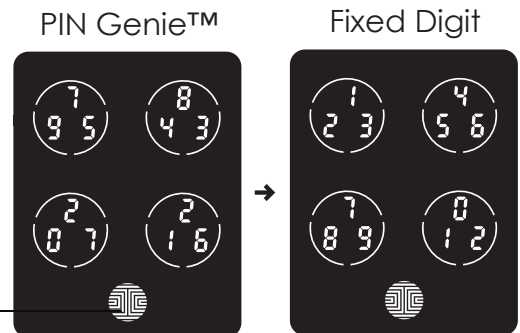

## 4.2 Locking/Unlocking Lockly with Fingerprints

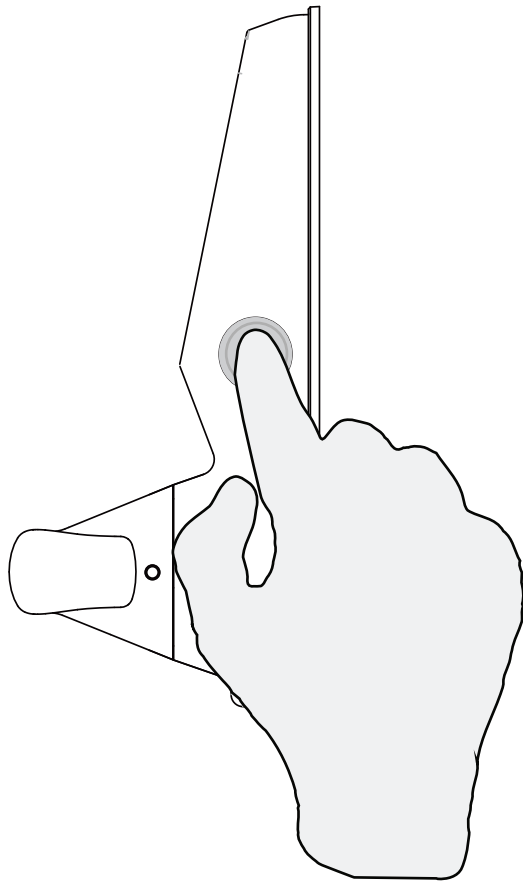

OK Button —————



### Unlocking

Place a registered finger to the fingerprint scanner located on the exterior side of the lock to the right.

To register a fingerprint, please see Section 3.6.

If your fingerprint is registered and acknowledged, you will hear a “beep” sound and a Green LED will light up on the fingerprint scanner. You can then push down the handle and open the door.

If you see a Red LED, it means your fingerprint is not recognized. You must wait until the red LED is off to try again.

For best fingerprint scanning practices, see Section 3.7.

### Locking

To lock your smart lock, press the OK Button anytime or brush your hand across the screen when the lock is unlocked.

## 4.3 Locking/Unlocking Lockly® with App

You must have the Lockly® iOS or Android app installed in order to lock and unlock with smartphone and connect with voice assistants like Alexa or Google Assistant. Please download the app by visiting the link below or search “Lockly” from the correct app store.



Scan or visit [Lockly.com/app](https://lockly.com/app)

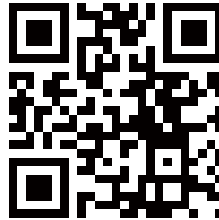

## 4.4 Locking/Unlocking with Physical Key

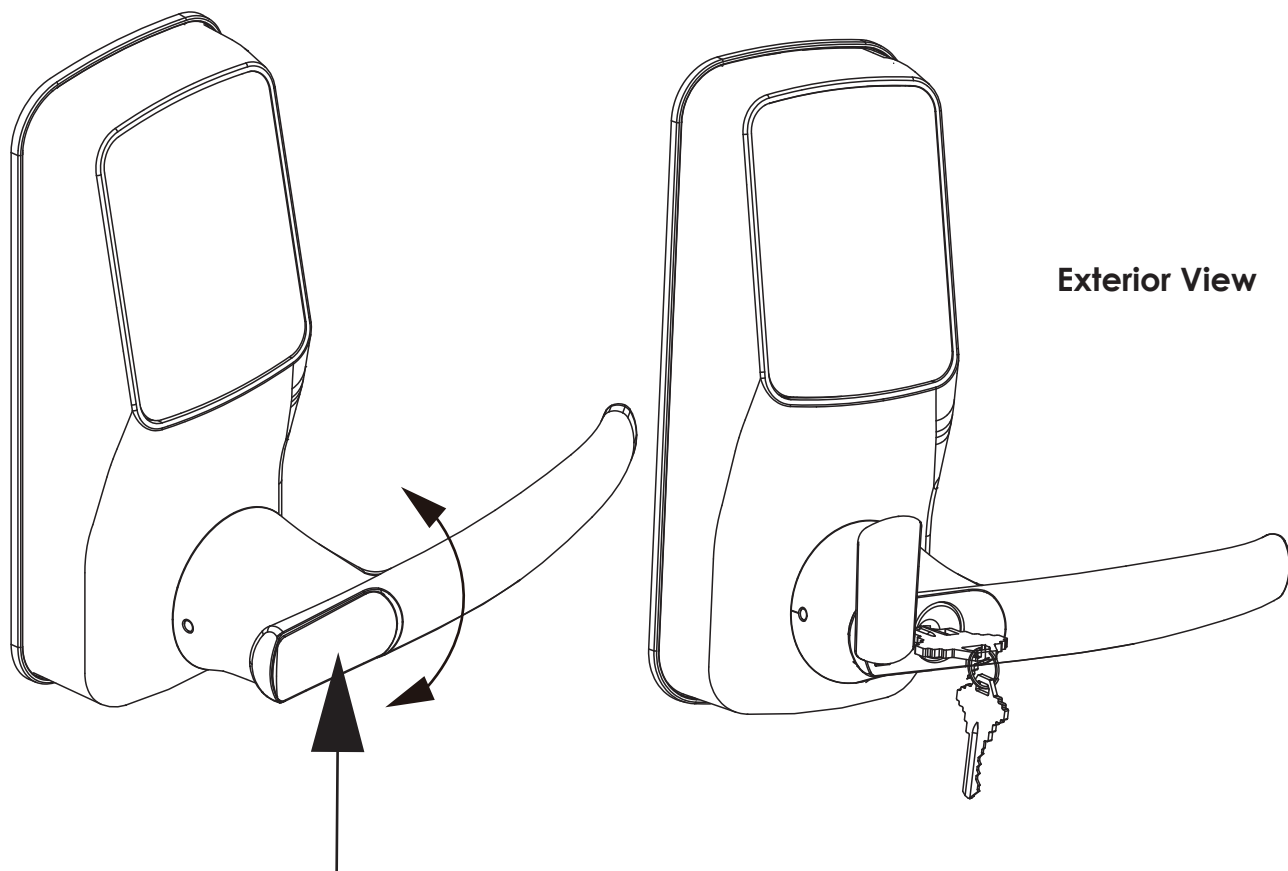

To **unlock** your lock using the **physical key (included)**, open the key cover on the handle by turning the cover to reveal the **keyhole**.

**Insert** your key and turn **clockwise** or **counter clockwise** to lock or unlock the door.

## 4.5 Locking/Unlocking with Door Handle

This smart lock is built with an anti-friction latch throw and a heavy steel deadbolt throw for added security. The latch throw can be setup to auto lock based on your customized timing through the Lockly app.

The deadbolt throw is connected to the door handle. To UNLOCK pull the handle downwards and push door to open. This action is necessary to open your door whenever you access by keypad, fingerprint, smartphone App or RFID card.

To LOCK from the inside or outside, pull the handle upwards. Ensure your deadbolt throw is always locked following this action.

## 4.6 Locking and Unlocking with Voice Assistants

Once your Lockly® Smart Lock and Secure Link<sup>1</sup> Wi-Fi Hub has been installed and configured correctly, make sure you enable the Lockly® Action for Google Assistant or the Amazon Alexa Skill before you can configure your voice to perform voice commands.

You can ask your questions such as door status or request for your door to be locked or unlocked



- "Hey Google, unlock my Back Door"\*
- "Hey Google, is my Back Door locked?"
- "Hey Google, lock my Back Door"
- "Hey Google, is my Back Door unlocked?"



- Alexa, unlock my Front Door.\*
- Alexa, is my Front Door locked?
- Hi Alexa, lock my Front Door.
- Alexa, is my Front Door unlocked?

\*Unlock requests will require additional voice security codes.  
You may configure it in the settings page.

<sup>1</sup>Sold separately

## 4.7 Safe Mode - Overview

Lockly will enter **Safe Mode** when three (3) consecutive wrong **Access Codes** are entered within 5 minutes. When in **Safe Mode**, the lock status icon  will start to flash.

To disable **Safe Mode**, you must unlock the door using the correct fingerprint or enter the correct **Access Code** twice in a row. Activate the keypad by pressing and holding  for 3 seconds.

Once the screen is activated, enter the correct **Access Code** carefully twice, pressing  after every time.

If you enter the wrong code, the keypad will then be disabled for **10 minutes**.

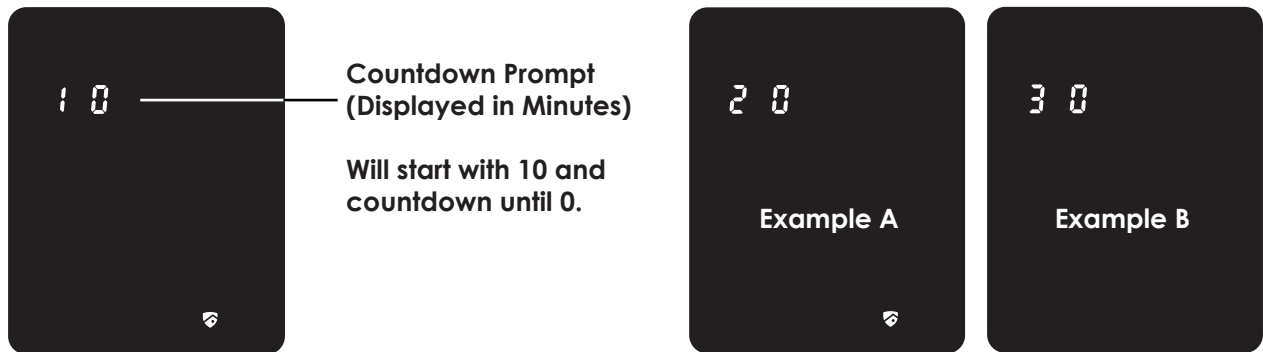

You will see a “10” on the screen, notifying the number of minutes that the keypad is disabled for. After **10 minutes**, you may attempt to enter the correct **Access Code** to unlock the door. After the second incorrect attempt to unlock the lock with the wrong **Access Code**, Lockly will disable the keypad for **20 minutes**, displaying a “20” on the screen. After the third wrong attempt to unlock the door with the correct **Access Code**, the screen will be disabled for **30 minutes**. (Example A and Example B above).

**Note:** In order to conserve power, the countdown prompt will only be displayed for 3 seconds. You can reactivate the screen by sliding your hand across the screen.



## 4.8 Disabling Safe Mode

There are four (4) ways to disable Safe Mode.

Option 1 - Entering Correct Access Code

Activate the keypad by pressing and holding  for 3seconds. Enter the correct **Access Code** twice (2) when the keypad is available, pressing  after every time the **Access Code** is entered.

Option 2 - Lockly Bluetooth App

Use the app that is synced to your Lockly to disable **Safe Mode** by unlocking the door. If you have not downloaded the app to use with your smart lock, you won't be able to use this option to disable **Safe Mode**.

Option 3 - Physical Key

There is a pair of keys included with your new lock. You may use the keys to manually **unlock** the door. To learn how to use your physical keys, see **Section 4.4**. To reactive the screen, use the **Keypad Display Switch** by toggling it OFF and ON.

Option 4 - Registered Fingerprint

Use any registered fingerprint to reactivate the keypad. The door will unlock and reactivate the keypad once a registered fingerprint is used.



While in Safe Mode, the keypad will not be lit up when you are using your Physical Key.

## 5.1 Offline Access Code™ (OAC)

The **Offline Access Code™ (OAC)** is a unique feature of our smart lock. It allows you to grant access to guests remotely without guests needing to download the app.

To use the **OAC** feature, make sure you download the Lockly app for iOS or Android first, and sync your smart lock to your mobile device. OAC can only be issued by the administrative owner of the lock.

From there, you can then issue an **Offline Access Code™** within the app.

Go to “**Access**” and choose “**Add a New User, then select Offline Access Code™ (OAC)**” and follow on screen instructions to generate your **Offline Access Code™**.

### Understanding Offline Access Code™ (OAC)

**OAC** are issued to the guest by asking them to enter 4-12 digit number after a double - click on the . Your Lockly randomly generates the **Offline Access Code™** which can be shared to your guests together with the instructions generated using the Lockly app.

After a double-click on the , touchscreen will display numbers on **Fixed Digit** mode, then guest can enter the **Offline Access Code™**.

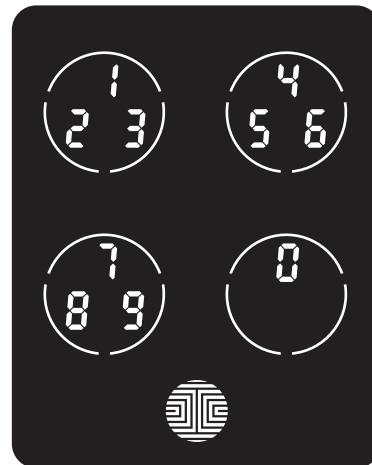

# 6.1 Important Notes

## Auto Lock Feature

Your lock can be programmed to auto-lock between 5-300 seconds after the door opening. You can select the timing through the Lockly App. If auto-lock is not activated and door is still open, the touchscreen will remain lighted, simply press the  on the keypad to lock.

## One-Touch Locking

You can always manually do a quick lock by touching anywhere on the touchscreen. Lockly smart lock is shipped with this feature already activated. You may deactivate this feature through the Lockly App.

## 9V Backup Access

When your **Lockly** is out of power, you can temporarily activate the keypad by using a 9V battery against the bottom of the exterior side of the smart lock. Please see **Section 2.6** for more info.

## Physical Keys

Even though you have your **fingerprints** registered and **Access Codes** stored, it's always best practice to carry your physical keys with you at all times in case for any reason your lock falls into **Safe Mode**.

## Activation Code

You may find an **Activation Code Card** with an **Activation Code** included in your package. It is very crucial that you do not lose this card. Please store this card safely as you will need the default **Activation Code** on that card to **master reset** your lock in case, for any reason, you have lost the phone paired to Lockly and also forgot your **Access Code**.

## Troubleshooting

Please visit <http://lockly.com/help> for troubleshooting and the most frequently asked questions and answers.

# 7.1 Cleaning

Making sure your Lockly is clean is best practice to ensure optimal product use. Follow the DOs and DON'Ts below.

## DO

- Rinse the touchscreen with warm water prior to cleaning.
- Use the application of soap with a damp, lukewarm cloth.
- Air dry or wipe dry with a soft microfiber cloth to avoid scratches.

## DON'T

- Don't use abrasives, high alkaline cleaners, or gasoline to clean your lock.
- Don't apply cleaning detergent directly in sunlight or at high temperatures.
- Don't leave cleaning detergent on the display keypad for long periods of time - wash immediately.
- Don't use scrapers, squeegees, or razors.

## 8.1 Safety Precautions

Please read all instructions carefully. Remind all Lockly users of the safety precautions.

### Read the following instructions for your own safety

Do not attempt to disassemble the smart lock by yourself. It can cause product damage, void warranty, and cause injuries.

Do not use any inappropriate tools that can cause damages or malfunction to your lock.

Always make sure your door is securely closed and locked when you leave your house to prevent unwanted entry.

Please keep your Access Codes safe. Restrict access to the back panel of your smart lock and check your settings regularly to ensure Access Codes have not been changed without your knowledge.

Always dispose of used batteries according to your local laws. DO NOT BURN.



**Unauthorized changes and modifications may void your product warranty. If you have questions or any problems while using your Lockly Lux Compact Smart Lock, contact our customer service department at [help@Lockly.com](mailto:help@Lockly.com) or visit <http://lockly.com/help> for technical assistance.**



**Certified**

**FCC Warning :**

This device complies with Part 15 of the FCC Rules. Operation is subject to the following two conditions: (1) This device may not cause harmful interference, and (2) this device must accept any interference received, including interference that may cause undesired operation.

**NOTE 1:** This equipment has been tested and found to comply with the limits for a Class B digital device, pursuant to part 15 of the FCC Rules. These limits are designed to provide reasonable protection against harmful interference in a residential installation. This equipment generates, uses and can radiate radio frequency energy and, if not installed and used in accordance with the instructions, may cause harmful interference to radio communications. However, there is no guarantee that interference will not occur in a particular installation. If this equipment does cause harmful interference to radio or television reception, which can be determined by turning the equipment off and on, the user is encouraged to try to correct the interference by one or more of the following measures:

- Reorient or relocate the receiving antenna.
- Increase the separation between the equipment and receiver.
- Connect the equipment into an outlet on a circuit different from that to which the receiver is connected.
- Consult the dealer or an experienced radio/TV technician for help.

**NOTE 2:** Any changes or modifications to this unit not expressly approved by the party responsible for compliance could void the user's authority to operate the equipment.

**FCC Radiation Exposure Statement**

The Secure Link Wi-Fi Hub complies with FCC radiation exposure limits set forth for an uncontrolled environment. It should be installed and operated with minimum distance 20cm between the radiator & your body.

**IC WARNING**

This device contains licence-exempt transmitter(s) that comply with Innovation, Science and Economic Development Canada's licence-exempt RSS(s).  
Operation is subject to the following two conditions:

- (1) This device may not cause interference.
- (2) This device must accept any interference, including interference that may cause undesired operation of the device.

L'émetteur/récepteur exempt de licence contenu dans le présent appareil est conforme aux CNR d'Innovation, Sciences et Développement économique Canada applicables aux appareils radio exempts de licence. L'exploitation est autorisée aux deux conditions suivantes:

1. L'appareil ne doit pas produire de brouillage;
2. L'appareil doit accepter tout brouillage radioélectrique subi, même si le brouillage est susceptible d'en compromettre le fonctionnement.

 **WARNING:** This product contains DEHP and other chemicals known to the State of California to cause cancer and birth defects, or other reproductive harm. For more information go to [www.P65Warnings.ca.gov](http://www.P65Warnings.ca.gov)

**LOCKLY LUX COMPACT**



We're here to help!  
[help@lockly.com](mailto:help@lockly.com)  
<https://lockly.com/help>

Lockly Smart Lock - Secure  
Lockly Smart Lock - Secure Plus  
Lockly Smart Lock - Secure Pro

# U.S. Patent No. 9,665,706

Other Patents Pending With All Rights Reserved

About Lockly Secure, Secure Plus and Secure Pro

About Lockly Secure, Secure Plus and Secure Pro are keyless smartlocks equipped with the patented PIN Genie™, which is a peep proof and hidden camera proof algorithm software. Lockly makes your life easier and safer.

For digital versions and instructional videos, please visit the following link:

<http://lockly.com/help>



