

# ASSEMBLY INSTRUCTION FOR MAXI ULTRA HS

**WARNING:** Serious injury or death can be caused by toppling furniture

**Help prevent tip-over:**

- Anchor this product to a wall or other suitable surface
- Check anchors regularly
- Avoid placing TVs on top unless the TV is also anchored
- Use drawer locks to prevent children climbing

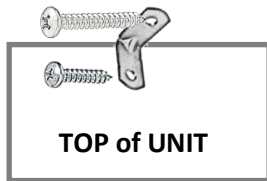



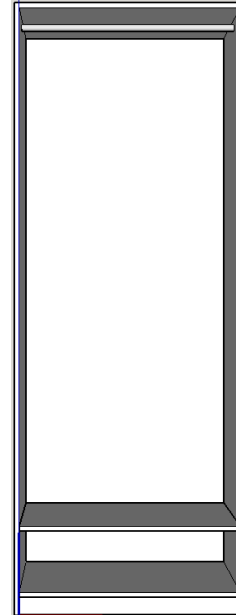



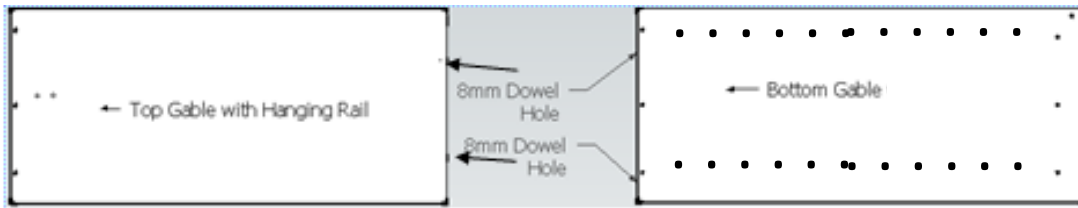

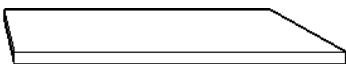

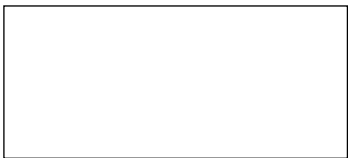
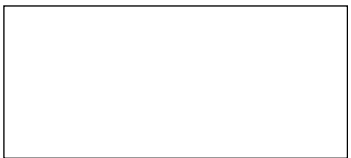

When attaching unit to wall put safety bracket in middle of unit with 16mm pan head screw then 25mm pan head screw into wall. For plasterboard without a stud it is recommended to use a plug with screw (not provided).



## PARTS IDENTIFICATION LIST



- 1x CAM SHELF 
- 2x FIXED SHELF 
- 1x 30mm HANGING RAIL 
- 1 BOTTOM KICK 
- 1x .....BACKING 
- 1x .....BACKING 

NO	MODEL	DESCRIPTION	QTY	NO	MODEL	DESCRIPTION	QTY
1		CONFIRMAT SCREWS 50mm x 5mm	15	6		CAMS	4
2		WHITE CAPS	15	7		CAM PINS	4
3		DOWELS	4	8		16mm PAN HEAD SCREWS	1
4		BACKING NAILS	60	9		25mm PAN HEAD SCREWS	1
5		16mm WOOD SCREW	2	10		"L" SAFETY BRACKET	1

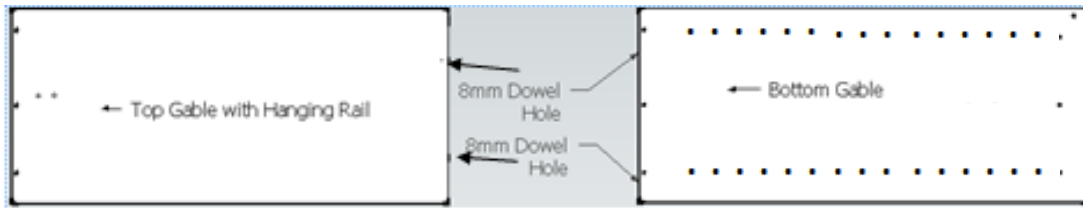

Take your gables and lay them out flat you should have 2 Top & 2 Bottom gables.

Using a little of wood glue (NOT SUPPLIED) in your pre-drilled holes, insert your Wood Dowels into 2 of the holes and push your top into your bottom gables.

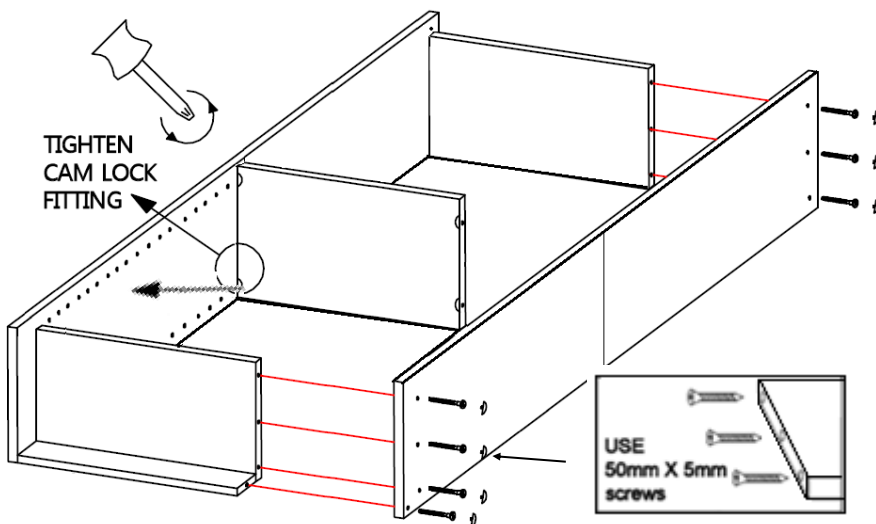

ALIGN FIXED SHELVES + KICK BOARD TO SIDE GABLES TIGHTEN ALL SCREWS AND CAP.

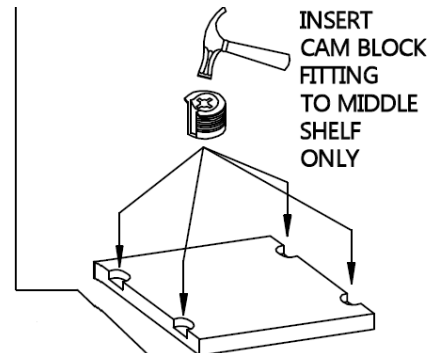

INSERT CAM BLOCK FITTING TO MIDDLE SHELF ONLY

**IMPORTANT**  
PLACE THE FITTING OVER HOLE, KEEPING THE SQUARE, EDGE OF THE FITTING PARALLEL TO THE FACE OF THE BOARD, KNOCK IN CAREFULLY

FOLD OUT BOTH TOP AND BOTTOM BACKS PROCEED TO NAIL THEM INTO POSITION MAKING SURE YOU ARE SQUARE.

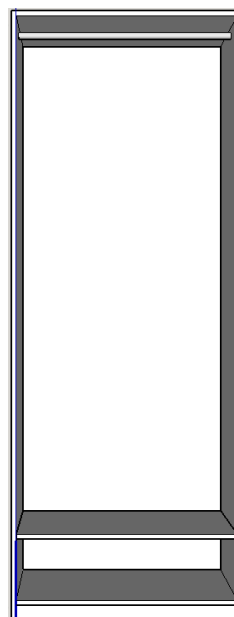
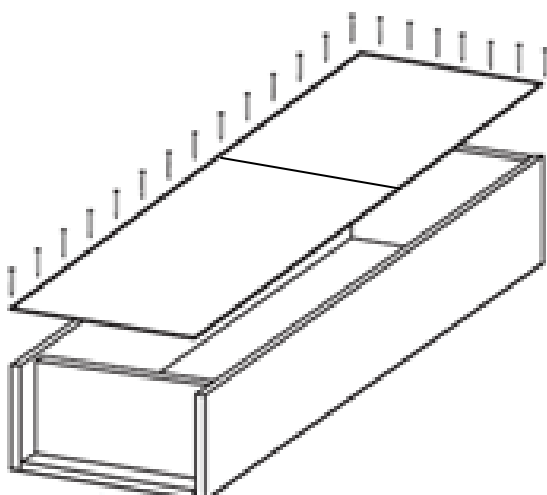

**THERE IS NO SCREWS NEEDED FOR THE NEXT STEP.**

TAP INTO POSITION YOUR FLANGES INTO THE HOLES PROVIDED AND INSERT YOUR HANGING RAIL.

**YOUR UNIT IS NOW READY TO BE PUT INTO PLACE.**