

IMPORTANT NOTICE

 NO OPERATING

Read this important Notice carefully before flying the APHUBX4.

1. The APHUBX4 will crash down if drone is over loaded. The maximum flying weight is **1460g**.

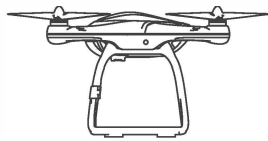

A

1115g

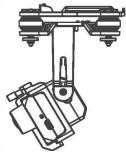

B

147g

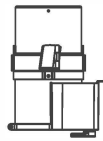

C

192g

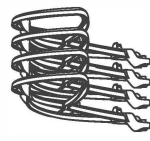

D

108g



Do not install both the parachute and propeller guard onto the APHUBX4 after installing the gimbal and camera. Doing so will exceed the maximum 1460g load, causing the APHUBX4 to crash and/or damage its surroundings. Parachute not included with this model.

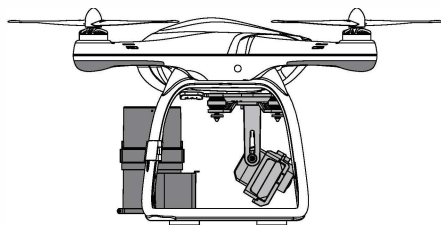

01: A+B+C=1454g

YES

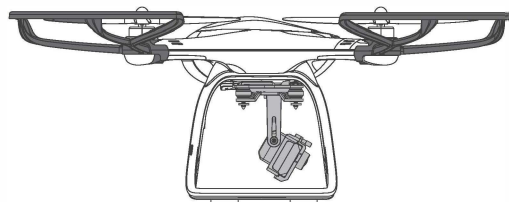

02: A+B+D=1370g

YES

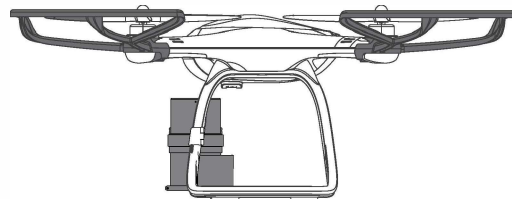

03: A+C+D=1415g

YES

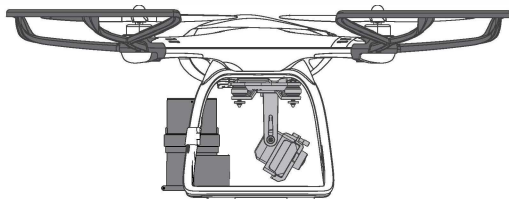

04: A+B+C+D=1562g

NO

2. Do not fly the APHUBX4 near high-line cables, magnetic fields, airports and similar areas. Do not fly in rainy weather.



High-line Cables

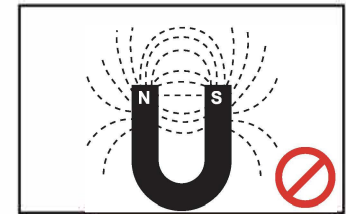

Magnetic Field

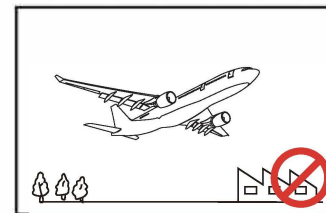

Airport



Raining

3. Do not fly the APHUBX4 near a magnetic field. There is a compass sensor in the X4 Pro's undercarriage that will need recalibration if it encounters magnetic interference.

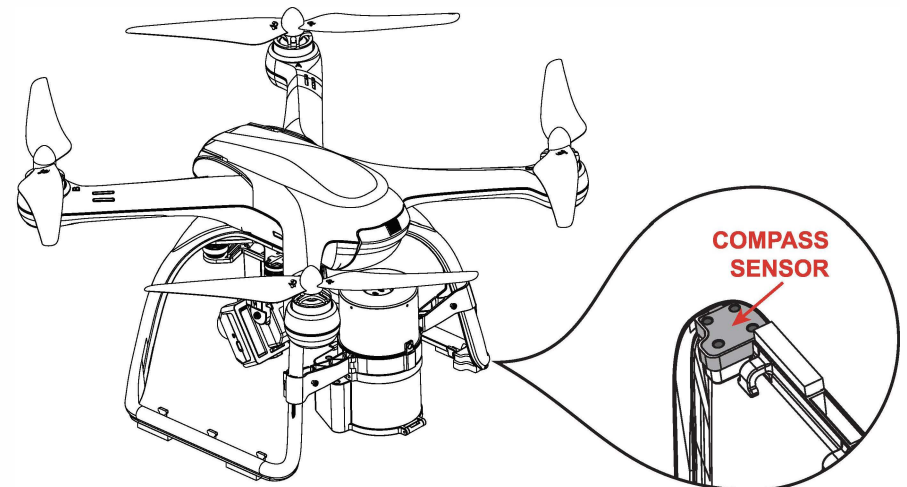

**COMPASS
SENSOR**