



2 X 18V LITHIUM ION

CORDLESS LAWN MOWER KIT

INSTRUCTION MANUAL

SPECIFICATIONS

Voltage:	18V x 2
Battery:	2.0Ah Li-ion
Charge Time:	2.5 hours
Cutting Diameter:	330mm
Cutting Heights:	25-65mm (5 settings)
No Load Speed:	3,400/min
Grass Catcher:	30 litres
Weight:	11.85kg

ozito.com.au

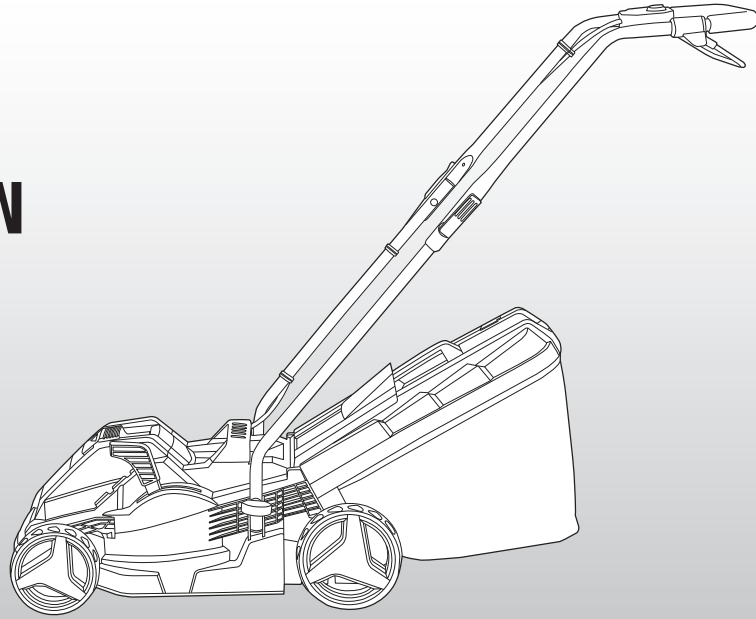

WHAT'S IN THE BOX

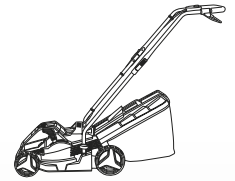

Cordless Lawn Mower



Safety Key

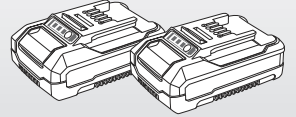

2 x 2.0Ah Batteries

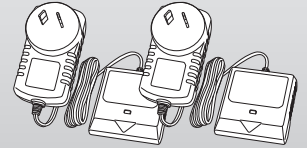

2 x Eco Charger

5 YEAR
REPLACEMENT WARRANTY*

PXCLMK-218E

WARRANTY

IN ORDER TO MAKE A CLAIM UNDER THIS WARRANTY YOU MUST RETURN THE PRODUCT TO YOUR NEAREST BUNNINGS WAREHOUSE WITH YOUR BUNNINGS REGISTER RECEIPT. PRIOR TO RETURNING YOUR PRODUCT FOR WARRANTY PLEASE TELEPHONE OUR CUSTOMER SERVICE HELPLINE:

Australia 1800 069 486

New Zealand 0508 069 486

TO ENSURE A SPEEDY RESPONSE PLEASE HAVE THE MODEL NUMBER AND DATE OF PURCHASE AVAILABLE. A CUSTOMER SERVICE REPRESENTATIVE WILL TAKE YOUR CALL AND ANSWER ANY QUESTIONS YOU MAY HAVE RELATING TO THE WARRANTY POLICY OR PROCEDURE.

WARNING

The following actions will result in the warranty being void.

- If the tool has been operated on a supply voltage other than that specified on the tool.
- If the tool shows signs of damage or defects caused by or resulting from abuse, accidents or alterations.
- Failure to perform maintenance as set out within the instruction manual.
- If the tool is disassembled or tampered with in any way.

The benefits provided under this warranty are in addition to other rights and remedies which are available to you at law.

Our goods come with guarantees that cannot be excluded at law. You are entitled to a replacement or refund for a major failure and for compensation for any other reasonably foreseeable loss or damage. You are also entitled to have the goods repaired or replaced if the goods fail to be of acceptable quality and the failure does not amount to a major failure.

Generally you will be responsible for all costs associated with a claim under this warranty, however, where you have suffered any additional direct loss as a result of a defective product you may be able to claim such expenses by contacting our customer service helpline above.

5 YEAR REPLACEMENT WARRANTY

Your Product is guaranteed for a period of 60 months from the original date of purchase and is intended for DIY (Do It Yourself) use only. If a product is defective it will be replaced in accordance with the terms of this warranty. **Lithium Ion batteries and chargers are covered by a 36 month warranty.** Warranty excludes consumable parts, for example: grass catcher, wheels, blade, cord clips, bearings etc..

KNOW YOUR PRODUCT

CORDLESS LAWN MOWER

- | | |
|---|----------------------------|
| 1. Wheels | 8. Upper Handle |
| 2. Battery Cover | 9. Lock-off Button |
| 3. Battery Cover Securing Latch | 10. Handle Securing Lever |
| 4. Height Adjustment Lever | 11. Start/Stop Lever |
| 5. Cord Clips </td <td>12. Grass Catcher</td> | 12. Grass Catcher |
| 6. Grass Catcher Flap | 13. Handle Fastening Screw |
| 7. Lower Handle | 14. Lifting Handle |

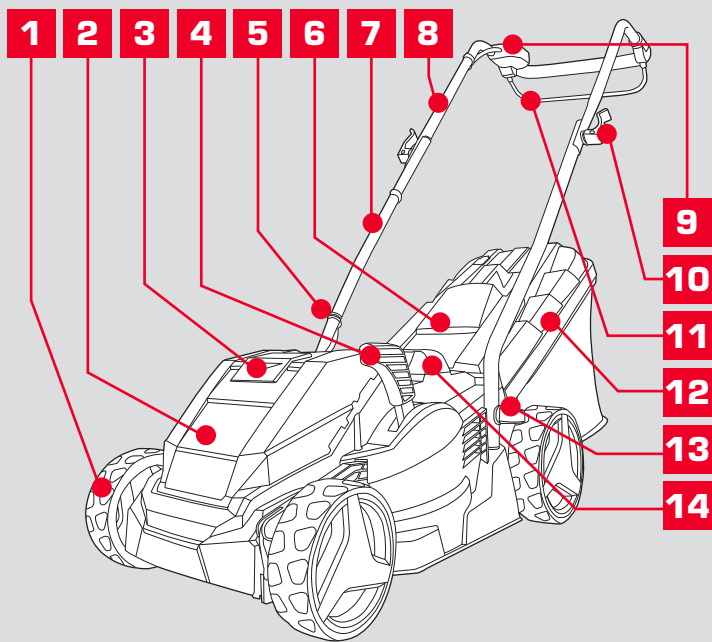

ACCESSORIES

- | | |
|-------------------------------------|-----------------|
| 15. Battery Release Tab | 18. Safety Key |
| 16. Battery Charge LED's | 19. Charger LED |
| 17. Battery Charge Indicator Button | 20. Charger |

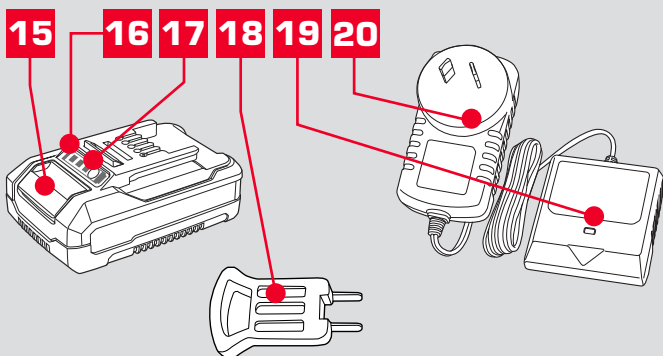

ONLINE MANUAL

Scan this QR Code with your mobile device to take you to the online manual.



5 YEAR
REPLACEMENT WARRANTY*

SETUP & PREPARATION

1. ASSEMBLY

WARNING! ENSURE THE TOOL IS SWITCHED OFF AND BATTERIES ARE DISCONNECTED BEFORE PERFORMING ANY OF THE FOLLOWING TASKS.

Fitting the Lower Handles

1. Place the lower handle into the mount.
2. Secure the lower handle with a washer and fastening screw.

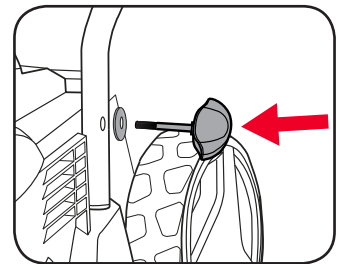
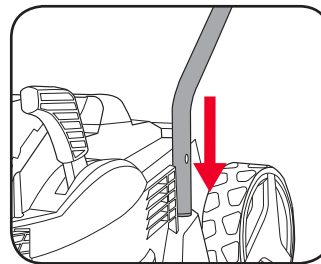

3. Repeat this process on the other side for the second lower handle.

Fitting the Upper Handle

1. Align the holes in the upper handle and lower handle.
2. Place the handle securing lever bolt through the holes from the inside.

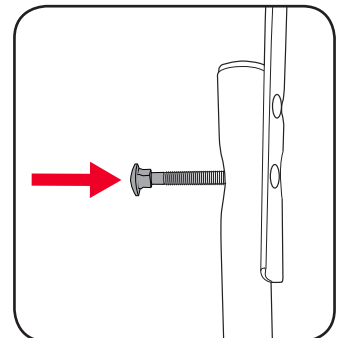
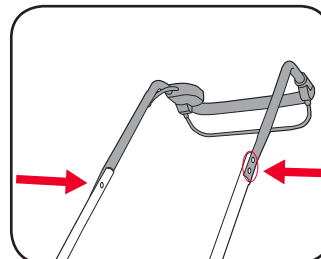

Note: There are 2 holes on each end of the upper handle, select the appropriate hole for the height of the user.

3. Place a washer and the handle securing lever onto the bolt.
4. Lock the handle securing lever to secure in place.

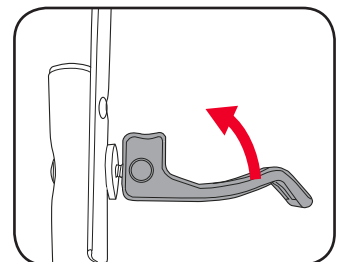
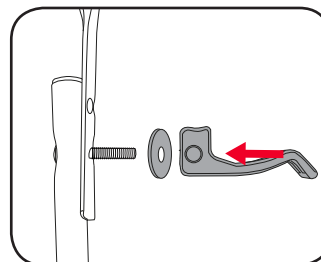

5. Repeat this process for the opposite side.

Securing the Cord

Ensure the cord follows the handle smoothly from the switch to the body of the mower.

1. Locate cord on outside of handle. Push the supplied cord clip over the cord and onto the lower handle to secure in place.

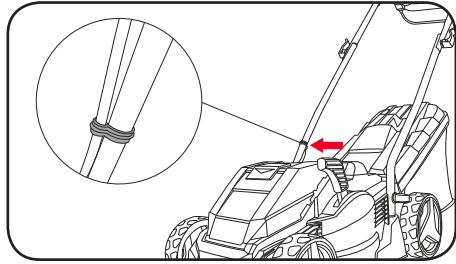

Note: Care should be taken not to impinge cord when folding down the handle.

Fitting and Removing the Grass Catcher

IMPORTANT! ONLY FIT AND REMOVE THE CATCHER WHEN THE MOWER IS SWITCHED OFF AND THE MOTOR HAS COME TO A STOP.

1. Lift up the catcher flap with one hand and guide the catcher with your other hand over the two hooks on the mower housing.
2. Lower the grass catcher and allow it to sit in place. Lower the catcher flap.

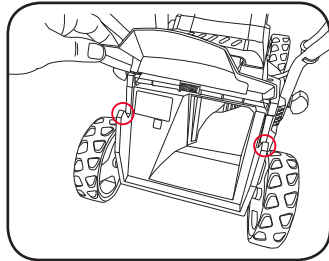

3. To remove, raise the flap and lift the catcher out.

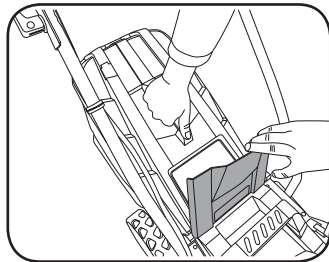

WARNING! WHEN FITTING THE GRASS CATCHER AFTER EMPTYING, ALWAYS ENSURE THERE IS NO BUILD UP OF GRASS IN THE GRASS CHUTE.

Grass Catcher Indicator

The grass catcher is fitted with an indicator flap at the rear of the catcher to help identify when to empty.

If the indicator flap is down while operating then the grass catcher is full and needs emptying.

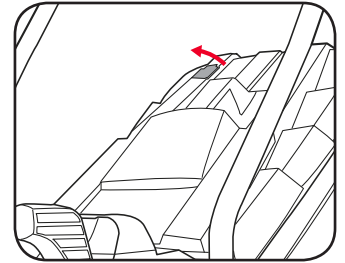

2. BATTERY & CHARGING

CAUTION: THE CHARGER FOR THIS PRODUCT SHOULD BE PROTECTED BY A RESIDUAL CURRENT DEVICE (RATED AT 30MA OR LESS).

Charging your lithium ion battery - Eco Charger

The tools battery has been shipped in a low charge condition, and requires charging prior to use. Allow several cycles of charging and discharging (through use of the tool) for the battery to reach its optimum performance / runtime.

CAUTION! IF THE BATTERY IS TOO HOT OR TOO COLD WHEN INSERTED INTO THE CHARGER, THE LED WILL FLASH RED AND GREEN. REMOVE BATTERY FROM CHARGER AND STORE AT ROOM TEMPERATURE 20°C BEFORE CHARGING.

1. Connect the charger into a mains power outlet.

2. The charger LED will flash green showing power is being supplied to the charger.

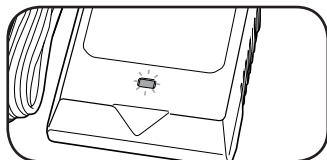

3. With the battery sitting on a flat surface, align the raised ribs on the battery with the recess in the charger and slide onto the battery ensuring a firm connection.

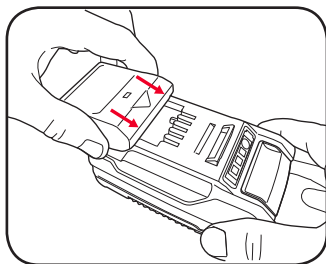

4. The charger LED will illuminate red signifying that the battery is charging.

Note: The battery will not develop a memory, it does not have to be fully discharged before recharging

5. When removing the charger from the battery, first press the battery release tab, then slide the charger from its position.

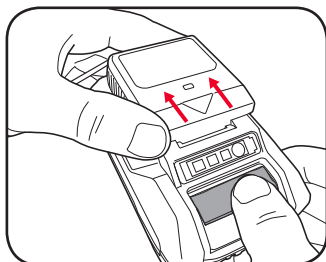

Charger LED Indicator

LED Indicator	Situation
GREEN (Flashing)	Stand By (no battery pack is inserted)
RED (Illuminated)	Battery is charging (low charge)
GREEN (Illuminated)	Battery is fully charged
RED (Flashing)	Battery or Charger fault
RED & GREEN (Flashing)	Battery pack is too hot or too cold (remove battery from charger and store at room temperature 20°C. Insert battery again when at correct charging temperature). If this happens again, the battery is defective and needs to be replaced.

Battery Charge Indicator

The purchased battery is equipped with a battery charge indicator to show the state of the battery charge.

Press the charge indicator button and look to see which LED lights.

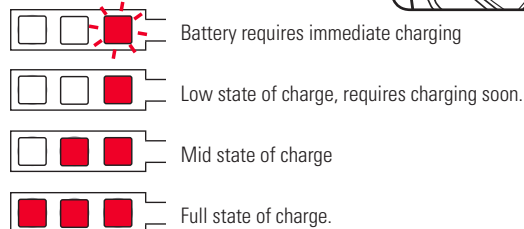
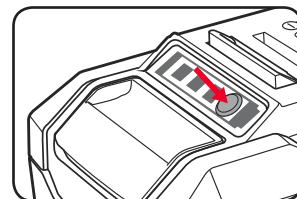

Note: The battery needs to be removed from the tool to check the state of charge.

Battery protection system

The tool is equipped with the battery protection system, which helps to ensure a long service life.

The output power automatically cuts off during operation when the tool and/or battery are placed under the following situations:

- When the tool is overloaded:**

If this occurs, release the start/stop lever safety key and batteries and remove causes of overload, then reinsert the safety key and batteries, then press and hold the lock-off button and pull the start stop lever again to restart.

- When the remaining battery capacity becomes low:**

Recharge the battery pack.

Note: The battery protection system does not in any way damage the tool.

Note: The indicated capacity may be lower than the actual level during use or immediately after using the tool.

Note: Always use 2 batteries of same capacity and same charge state with the mower.

OPERATION

3. INSERTING & REMOVING THE BATTERIES

Inserting the Batteries into the Mower

Note: Always use 2 batteries of same capacity and same charge state with the mower.

1. Pull the securing latch forward and open the battery cover.
2. Slide two batteries of the same capacity and same charge state into the mower aligning the ribs so that they click into place.

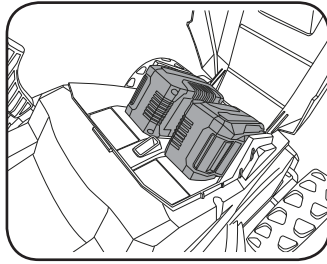
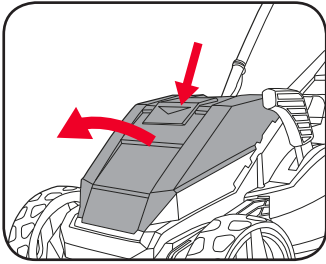

3. Insert the safety key.
(If the mower is not going to be used immediately, do not insert the safety key.)

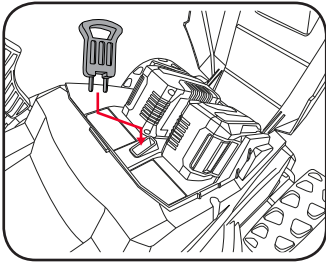

4. Close the battery cover.

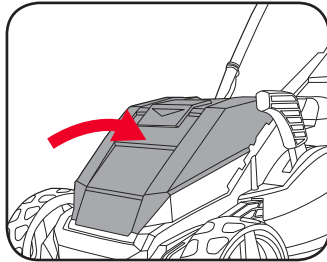

Removing the Batteries from the Mower

1. Pull the securing latch forward and open the battery cover.

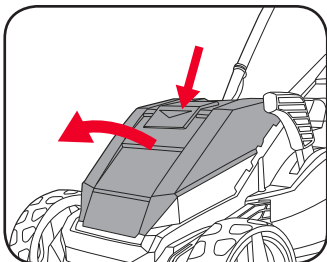

2. Press the battery release tab and remove the batteries.

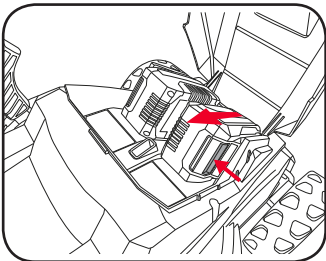

3. Close the battery cover.

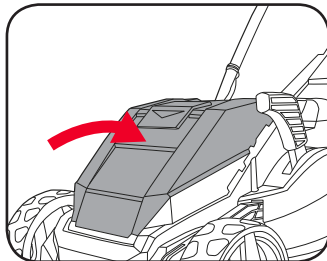

4. CONTROLS

Switching On and Off

To prevent accidental start up, the mower is fitted with a dual action switch.

1. Press and hold the lock-off button.
2. Pull the start/stop lever towards the handle to start the mower and then release the lock-off button.

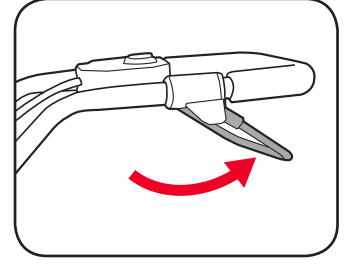
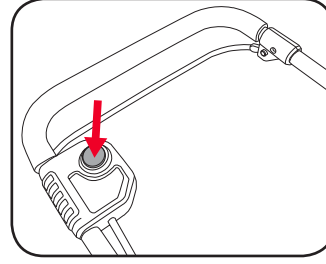

3. Release the start/stop lever to stop the mower.

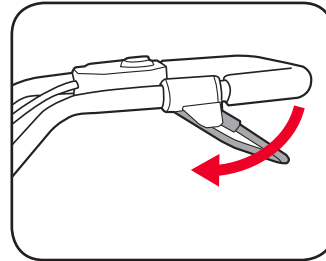

Adjusting the Cutting Height

The height adjustment lever provides 5 cutting heights from 25mm to 65mm.

1. Push lever downwards into the mower body.
2. Adjust until the required cutting height is selected.
3. Release lever and check that it is securely seated in the required cutting height.

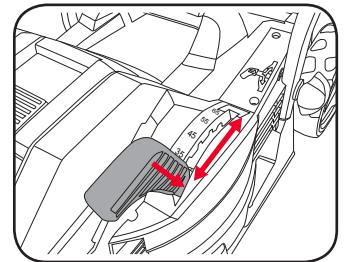

CAUTION: BE CAREFUL DURING CUTTING HEIGHT ADJUSTMENTS TO PREVENT ENTRAPMENT OF THE FINGERS BETWEEN MOVING HEIGHT ADJUSTMENT LEVER AND THE MOWER HOUSING.

OPERATION

5. MOWING

- While using your lawn mower always wear substantial closed, heavy footwear and long trousers.
- Make sure the lawn is clear of sticks, stones, wire and debris; they could be thrown by the blade.
- Before using the lawn mower and after any impact, check for signs of wear or damage and repair as necessary.
- Replace a worn or damaged blade together with the blade bolt to preserve balance.

Lawn Mowing Tips

Start mowing the edge of the lawn and work along making sure to overlap each pass by a few centimetres.

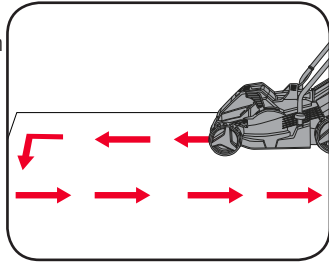

For optimum grass collection, always mow in a straight line; do not swing the lawn mower from side to side.

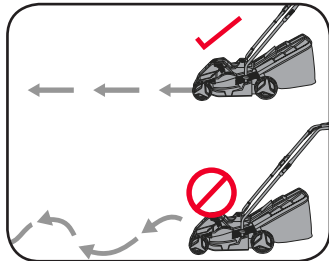

When mowing long grass be sure to not overload the motor. First cut with the highest cutting height and then to the desired height. This will help reduce the load.

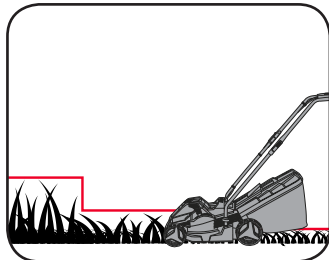

IMPORTANT! DO NOT MOW WITH POOR VISIBILITY CONDITIONS, IN THE RAIN OR WHEN GRASS IS WET.

MAINTENANCE



WARNING! ALWAYS ENSURE THE LAWN MOWER BLADE HAS COMPLETELY STOPPED, REMOVE SAFETY KEY, BATTERY AND GRASS CATCHER PRIOR TO ANY MAINTENANCE.

Removing and Fitting the Blade



CAUTION! ALWAYS USE GLOVES WHEN HANDLING THE BLADE. SHARP EDGES COULD CAUSE INJURY.

1. To remove the blade bolt, hold the blade firmly and with a 13mm socket loosen the blade bolt by turning it anti-clockwise.

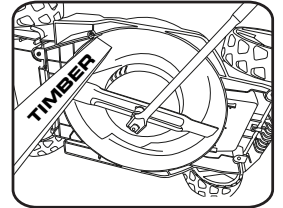

NOTE: A piece of timber will assist in holding the blade while removing or tightening the blade bolt.

2. Remove the blade bolt, washer and blade.

Replace the metal blade after 50 hours mowing or 2 years whichever is sooner. If the blade is cracked or damaged replace it with a new one.

3. To fit the blade, place the blade over the centre hole aligning the lugs.
4. Tighten the blade bolt firmly with a 13mm socket by turning it clockwise. Do not overtighten.

Cleaning, Maintenance and Storage

- Keep all nuts, bolts and screws tight to be sure the lawn mower is in a safe working condition.
- Check the catcher frequently for wear or deterioration.
- Replace worn or damaged parts for safety.
- Only use the replacement blade and blade bolt specified for this product.
- Be careful during adjustments of the lawn mower to prevent entrapment of the fingers between moving blade and fixed parts of the machine.
- When not in use, the mower should be stored in a dry, frost-free location, out of reach of children. If the housing of the mower requires cleaning, do not use solvents but a moist soft cloth and brush only.
- Frequently check the wheel threads are firm and tight.

Note: Ozito Industries will not be responsible for any damage or injuries caused by the repair of the lawn mower by an unauthorised person or by mishandling of the lawn mower. This tool is designed for DIY use - use in commercial or industrial environments will void the warranty.

TROUBLESHOOTING

Problem	Cause	Remedy
Mower is not starting	Possible clogging	Check underneath the mower and clear out as necessary
	Battery is low in charge	Charge battery
	Battery not inserted properly	Insert battery pack correctly
	Grass too long	Raise the cutting height to reduce starting load
	Safety key not inserted correctly	Fit correctly
Mower is hard to push	Height of cut too low	Raise cutting height
	Cutting blade blunt	Replace blade
	Possible clogging	Check underneath the mower and clear out as necessary
	Grass too long	Raise the cutting height and walk slower
	Grass too dense	Raise the cutting height and walk slower and cut more frequently
	Wet grass	Wait until the grass dries before mowing
Motor stops while cutting	Height of cut too low	Raise the cutting height
	Battery has no power	Charge battery
Mower is not catching grass properly	Height of cut too low	Raise the cutting height
	Wet grass	Wait until the grass dries before mowing
Mower vibrating	Bent or damaged blade	Replace blade

SPARE PARTS

Spare Part	Part No.
Battery pack 2.0Ah	PXBP-200
Eco charger	PXCG-120

Spare parts can be ordered from the Special Orders Desk at your local Bunnings Warehouse.
For further information, or any parts not listed here, visit www.ozito.com.au or contact Ozito Customer Service:
Australia 1800 069 486
New Zealand 0508 069 486
E-mail: enquires@ozito.com.au

CARING FOR THE ENVIRONMENT



Power tools that are no longer usable should not be disposed of with household waste but in an environmentally friendly way. Please recycle where facilities exist. Check with your local council authority for recycling advice.



Recycling packaging reduces the need for landfill and raw materials. Reuse of recycled material decreases pollution in the environment. Please recycle packaging where facilities exist. Check with your local council authority for recycling advice.



BATTERY AND CHARGER SAFETY WARNINGS

THIS MANUAL CONTAINS IMPORTANT SAFETY AND OPERATING INSTRUCTIONS FOR YOUR BATTERY CHARGER.

- Before using the charger read all instructions and cautionary markings on the charger, battery pack and the product using the battery pack.
- This charger is not intended for any uses other than charging rechargeable batteries. Any other use may result in risk of fire, electric shock or electrocution.
- Do not place any object on top of the charger or place the charger on a soft surface that may result in excessive internal heat. Place the charger in a position away from any heat source.
- To reduce risk of damage to the electric plug and cord, pull by the plug rather than the cord when disconnecting the charger.
- Make sure the cord is located so that it will not be stepped on, tripped over, or otherwise subjected to damage or stress.
- An extension cord should not be used unless absolutely necessary. Use of an improper extension cord could result in the risk of fire, electric shock or electrocution.
- Do not operate the charger if it has received a sharp blow, been dropped or otherwise damaged in any way. Have it checked by an electrician or power tool repairer.
- Do not disassemble charger. Take it to an electrician or power tool repairer when service or repair is required. Incorrect reassembly may result in a risk of electric shock, electrocution or fire.
- To reduce risk of electric shock, unplug the charger from the outlet before attempting any cleaning. Removing the battery pack will not reduce this risk.
- Never attempt to connect 2 chargers together.
- DO NOT store or use the tool and battery pack in locations where the temperature may reach or exceed 40°C (such as inside sheds or metal buildings in summer).
- The charger is designed to operate on standard household electrical power (240 volts). Do not attempt to use it on any other voltage!
- The battery pack is not fully charged out of the carton. First read the safety instructions and then follow the charging notes and procedures.
- The longest life and best performance can be obtained if the battery pack is charged when the air temperature is between 18 - 24°C. Do not charge the battery pack in an air temperature below 10°C or above 40°C. This is important and will prevent damage to the battery pack.
- Do not incinerate the battery pack even if it is seriously damaged or is completely worn out. The battery can explode in a fire.
- Never attempt to open the battery pack for any reason. If the plastic housing of the battery pack breaks or cracks, immediately discontinue use and do not recharge.
- During charging, the battery must be placed in a well ventilated area.

DESCRIPTION OF SYMBOLS

V	Volts	Hz	Hertz
~	Alternating current	W	Watts
dc/---	Direct current	∅	Diameter
mA	Milliamperes	no	No load speed
/min	Revolutions or reciprocation per minute		Double insulated
	Regulator compliance mark		Transformer Energy Rating (MEPS)
Nm	Newton Meters		Read instruction manual
	Thermal cut-out protection		Pull out Safety Key before carry out any repair work
	Indoor use only		Warning
	Lithium Ion- battery		Do not use or store battery in temperatures exceeding 50°C
	Recycle battery		Do not put in the rubbish
	Do not incinerate		Do not get battery wet
	Always keep the lawnmower on the ground when mowing. Tilting or lifting the lawnmower may cause stones to be thrown out.		
	Keep bystanders away. Do not mow whilst people especially children or pets are in the mowing area.		
	Beware of severing toes or hands. Do not put hands or feet near a rotating blade.		
	Blade continues to rotate after the machine is switched off. Wait until all machine components have completely stopped before touching them.		
	Do not mow in the rain or leave the lawnmower outdoors while raining.		



ELECTRICAL SAFETY



WARNING! When using mains-powered tools, basic safety precautions, including the following, should always be followed to reduce risk of fire, electric shock, personal injury and material damage.

Read the whole manual carefully and make sure you know how to switch the tool off in an emergency, before operating the tool. Save these instructions and other documents supplied with this tool for future reference.

The charger has been designed for 230V and 240V only. Always check that the power supply corresponds to the voltage on the rating plate.

Note: The supply of 230V and 240V on Ozito tools are interchangeable for Australia and New Zealand.



This tool's charger is double insulated, therefore no earth wire is required.

If the supply cord is damaged, it must be replaced by an electrician or a power tool repairer in order to avoid a hazard.

Note: Double insulation does not take the place of normal safety precautions when operating this tool. The insulation system is for added protection against injury resulting from a possible electrical insulation failure within the tool.

Using an Extension Lead

Always use an approved extension lead suitable for the power input of this tool. Before use, inspect the extension lead for signs of damage, wear and ageing. Replace the extension lead if damaged or defective.

When using an extension lead on a reel, always unwind the lead completely. Use of an extension lead not suitable for the power input of the tool or which is damaged or defective may result in a risk of fire and electric shock.

The power supply for this product's charger should be protected by a residual current device (rated at 30mA or less). A residual current device reduces the risk of electric shock.



GENERAL POWER TOOL SAFETY WARNINGS



WARNING! Read all safety warnings and all instructions. Failure to follow the warnings and instructions may result in electric shock, fire and/or serious injury.

Save all warnings and instructions for future reference. The term "power tool" in the warnings refers to your mains-operated (corded) power tool or battery-operated (cordless) power tool.

1. Work area safety

- Keep work area clean and well lit.** Cluttered or dark areas invite accidents.
- Do not operate power tools in explosive atmospheres, such as in the presence of flammable liquids, gases or dust.** Power tools create sparks which may ignite the dust or fumes.
- Keep children and bystanders away while operating a power tool.** Distractions can cause you to lose control.

2. Electrical safety

- Power tool plugs must match the outlet. Never modify the plug in any way. Do not use any adapter plugs with earthed (grounded) power tools.** Unmodified plugs and matching outlets will reduce risk of electric shock.
- Avoid body contact with earthed or grounded surfaces, such as pipes, radiators, ranges and refrigerators.** There is an increased risk of electric shock if your body is earthed or grounded.
- Do not expose power tools to rain or wet conditions.** Water entering a power tool will increase the risk of electric shock.
- Do not abuse the cord. Never use the cord for carrying, pulling or unplugging the power tool. Keep cord away from heat, oil, sharp edges or moving parts.** Damaged or entangled cords increase the risk of electric shock.
- When operating a power tool outdoors, use an extension cord suitable for outdoor use.** Use of a cord suitable for outdoor use reduces the risk of electric shock.
- If operating a power tool in a damp location is unavoidable, use a residual current device (RCD) protected supply.** Use of an RCD reduces the risk of electric shock.

3. Personal safety

- Stay alert, watch what you are doing and use common sense when operating a power tool. Do not use a power tool while you are tired or under the influence of drugs, alcohol or medication.** A moment of inattention while operating power tools may result in serious personal injury.
- Use personal protective equipment. Always wear eye protection.** Protective equipment such as dust mask, non-skid safety shoes, hard hat, or hearing protection used for appropriate conditions will reduce personal injuries.
- Prevent unintentional starting. Ensure the switch is in the off-position before connecting to power source and/or battery pack, picking up or carrying the tool.** Carrying power tools with your finger on the switch or energising power tools that have the switch on invites accidents.
- Remove any adjusting key or wrench before turning the power tool on.** A wrench or a key left attached to a rotating part of the power tool may result in personal injury.
- Do not overreach. Keep proper footing and balance at all times.** This enables better control of the power tool in unexpected situations.

- Dress properly. Do not wear loose clothing or jewellery. Keep your hair, clothing and gloves away from moving parts.** Loose clothes, jewellery or long hair can be caught in moving parts.
- If devices are provided for the connection of dust extraction and collection facilities, ensure these are connected and properly used.** Use of dust collection can reduce dust-related hazards.

4. Power tool use and care

- Do not force the power tool. Use the correct power tool for your application.** The correct power tool will do the job better and safer at the rate for which it was designed.
- Do not use the power tool if the switch does not turn it on and off.** Any power tool that cannot be controlled with the switch is dangerous and must be repaired.
- Disconnect the plug from the power source and/or the battery pack from the power tool before making any adjustments, changing accessories, or storing power tools.** Such preventive safety measures reduce the risk of starting the power tool accidentally.
- Store idle power tools out of the reach of children and do not allow persons unfamiliar with the power tool or these instructions to operate the power tool.** Power tools are dangerous in the hands of untrained users.
- Maintain power tools. Check for misalignment or binding of moving parts, breakage of parts and any other condition that may affect the power tool's operation. If damaged, have the power tool repaired before use.** Many accidents are caused by poorly maintained power tools.
- Keep cutting tools sharp and clean.** Properly maintained cutting tools with sharp cutting edges are less likely to bind and are easier to control.
- Use the power tool, accessories and tool bits etc. in accordance with these instructions, taking into account the working conditions and the work to be performed.** Use of the power tool for operations different from those intended could result in a hazardous situation.

5. Battery tool use and care

- Recharge only with the charger specified by the manufacturer.** A charger that is suitable for one type of battery pack may create a risk of fire when used with another battery pack.
- Use power tools only with specifically designated battery packs.** Use of any other battery packs may create a risk of injury and fire.
- When battery pack is not in use, keep it away from other metal objects, like paper clips, coins, keys, nails, screws or other small metal objects, that can make a connection from one terminal to another.** Shorting the battery terminals together may cause burns or a fire.
- Under abusive conditions, liquid may be ejected from the battery; avoid contact. If contact accidentally occurs, flush with water. If liquid contacts eyes, additionally seek medical help.** Liquid ejected from the battery may cause irritation or burns.

6. Service

- Have your power tool serviced by a qualified repair person using only identical replacement parts.** This will ensure that the safety of the power tool is maintained.



LAWN MOWER SAFETY WARNINGS



WARNING! If not used properly this lawn mower can be dangerous!

This lawn mower can cause serious injury to the operator and others, the warnings and safety instructions must be followed to ensure reasonable safety and efficiency in using this lawn mower. The operator is responsible for following the warning and safety instructions in this manual and on the lawn mower. Never use the mower unless the catcher or guards provided by the manufacturer are in the correct position.

1) Training

- Read the instructions carefully. Be familiar with the controls and the proper use of the appliance.
- Never allow children or people unfamiliar with these instructions to use the appliance. Local regulations may restrict the age of the operator.
- Never mow while people, especially children, or pets are nearby.
- The operator or user is responsible for accidents or hazards occurring to other people or their property
- Know your controls. Read the manual carefully. Learn how to stop the engine quickly in an emergency.

2) Preparation

- While mowing, always wear substantial footwear and long trousers.
- Do not operate the appliance when barefoot or wearing open sandals.
- Thoroughly inspect the area where the appliance is to be used and remove all stones, sticks, wires, bones, and other foreign objects. They could be thrown by the blade.
- Before using, always visually inspect to see that the blades, blade bolts and cutter assembly are not worn or damaged. Replace worn or damaged blades and bolts in sets to preserve balance.

DAMAGED BLADES AND WORN BOLTS ARE MAJOR HAZARDS.

- On multi-bladed appliances, take care as rotating one blade can cause other blades to rotate.

3) Operation

- Mow only in daylight or in good artificial light.
- Avoid operating the appliance in wet grass, where feasible.
- Always be sure of your footing on slopes.
- Walk, never run.
- For wheeled rotary mowers, mow across the face of slopes, never up and down.
- Exercise extreme caution when changing direction on slopes.
- Do not mow excessively steep slopes.
- Use extreme caution when reversing or pulling the appliance towards you.
- Never cut grass while walking backwards.
- Stop the blade(s) if the appliance has to be tilted for transportation when crossing surfaces other than grass, and when transporting the appliance to and from the area to be mowed such as gravel drives, walks or roads.
- Never operate the appliance with defective guards or shields, or without safety devices, for example deflectors and/or grass catchers, in place.

- Start the motor according to instructions and with feet well away from the blade(s).
- Do not tilt the appliance when starting the motor, except if the appliance has to be tilted for starting. In this case, do not tilt it more than absolutely necessary and lift only the part which is away from the operator. Always ensure that both hands are in the operating position before returning the appliance to the ground.
- Do not put hands or feet near or under rotating parts. For rotary mowers, keep clear of the discharge opening at all times.
- Never pick up or carry an appliance while the motor is running.
- Stop the motor:
 - whenever you leave the machine;
 - before clearing a blockage;
 - before checking, cleaning or working on the appliance;
 - after striking a foreign object. Inspect the appliance for damage and make repairs as necessary;
 - if the appliance starts to vibrate abnormally (check immediately).
- Do not over-speed the mower or alter governor settings. Excessive speed is dangerous and shortens mower life.

4) Maintenance and storage

- Keep all nuts, bolts, and screws tight to be sure the appliance is in safe working condition.
- Check the grass catcher frequently for wear or deterioration.
- Replace worn or damaged parts for safety.
- For cylinder mowers, be careful during adjustment of the appliance to prevent entrapment of the fingers between moving blades and fixed parts of the appliance.
- Store the mower in a well-ventilated room away from naked flames such that may be found in hot water heaters.



18V LITHIUM ION

CORDLESS GRASS TRIMMER

INSTRUCTION MANUAL

SPECIFICATIONS

Voltage:	18V
No Load Speed:	8,500/min
Cutting Diameter:	240mm
Weight:	1.57kg

ozito.com.au

5 YEAR
REPLACEMENT WARRANTY

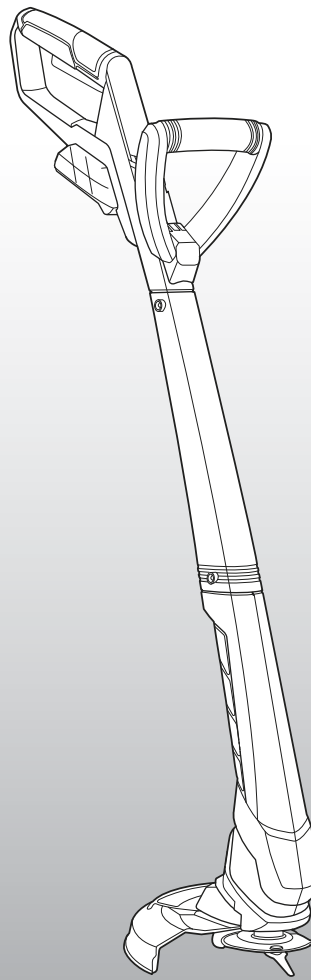

WHAT'S IN THE BOX



Grass Trimmer

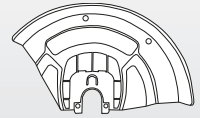

Safety Guard

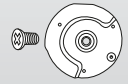

Spindle Plate & Screw



Secondary Handle & Blades x 20



Assembly Screws x 4

PXCGTK-018

WARRANTY

IN ORDER TO MAKE A CLAIM UNDER THIS WARRANTY YOU MUST RETURN THE PRODUCT TO YOUR NEAREST BUNNINGS WAREHOUSE WITH YOUR BUNNINGS REGISTER RECEIPT. PRIOR TO RETURNING YOUR PRODUCT FOR WARRANTY PLEASE TELEPHONE OUR CUSTOMER SERVICE HELPLINE:

Australia 1800 069 486

New Zealand 0508 069 486

TO ENSURE A SPEEDY RESPONSE PLEASE HAVE THE MODEL NUMBER AND DATE OF PURCHASE AVAILABLE. A CUSTOMER SERVICE REPRESENTATIVE WILL TAKE YOUR CALL AND ANSWER ANY QUESTIONS YOU MAY HAVE RELATING TO THE WARRANTY POLICY OR PROCEDURE.

WARNING

The following actions will result in the warranty being void.

- If the tool has been operated on a supply voltage other than that specified on the tool.
- If the tool shows signs of damage or defects caused by or resulting from abuse, accidents or alterations.
- Failure to perform maintenance as set out within the instruction manual.
- If the tool is disassembled or tampered with in any way.

The benefits provided under this warranty are in addition to other rights and remedies which are available to you at law.

Our goods come with guarantees that cannot be excluded at law. You are entitled to a replacement or refund for a major failure and for compensation for any other reasonably foreseeable loss or damage. You are also entitled to have the goods repaired or replaced if the goods fail to be of acceptable quality and the failure does not amount to a major failure.

Generally you will be responsible for all costs associated with a claim under this warranty, however, where you have suffered any additional direct loss as a result of a defective product you may be able to claim such expenses by contacting our customer service helpline above.

5 YEAR REPLACEMENT WARRANTY

Your Product is guaranteed for a period of 60 months from the original date of purchase and is intended for DIY (Do It Yourself) use only. If a product is defective it will be replaced in accordance with the terms of this warranty. **Lithium Ion batteries and chargers are covered by a 36 month warranty.** Warranty excludes consumable parts, for example: cutting blades.

KNOW YOUR PRODUCT

CORDLESS GRASS TRIMMER

- | | |
|---------------------|------------------|
| 1. Handle | 6. Blade Mount |
| 2. On/Off Trigger | 7. Spindle Plate |
| 3. Secondary Handle | 8. Cutting Blade |
| 4. Battery Seating | 9. Motor housing |
| 5. Safety Guard | |

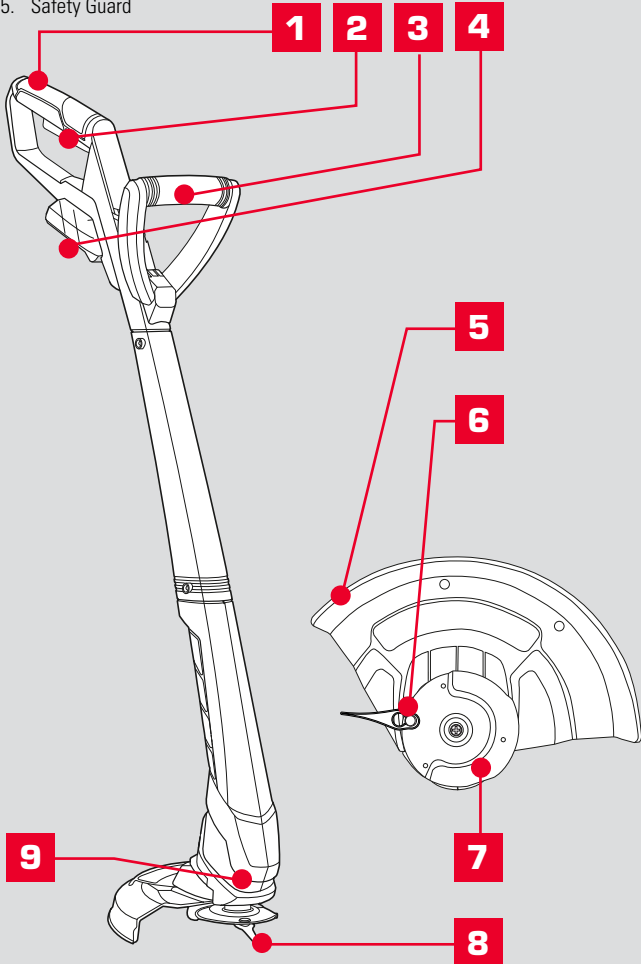

ACCESSORIES

- | | |
|-----------------|-------------------------|
| 10. Blades x 20 | 11. Assembly Screws x 4 |
|-----------------|-------------------------|

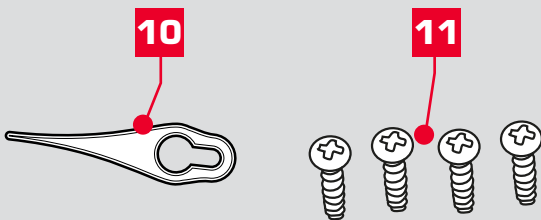

ONLINE MANUAL

Scan this QR Code with your mobile device to take you to the online manual.



5 YEAR
REPLACEMENT WARRANTY

SETUP & PREPARATION

1. ASSEMBLY

WARNING! ENSURE THE TOOL IS SWITCHED OFF AND BATTERY DISCONNECTED BEFORE PERFORMING ANY OF THE FOLLOWING TASKS.

Housing Assembly

1. Align the three parts of the housing, and insert as far as possible.
2. Secure the three parts in place on both sides with the four housing assembly screws provided.

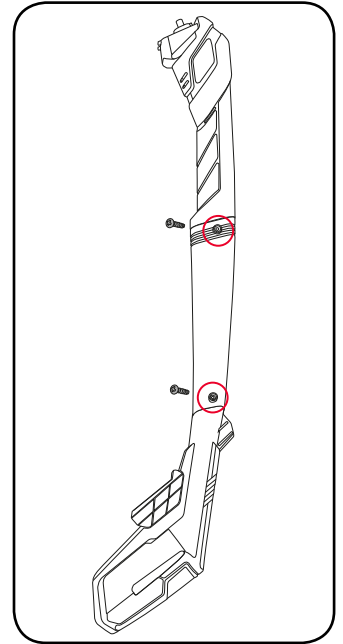
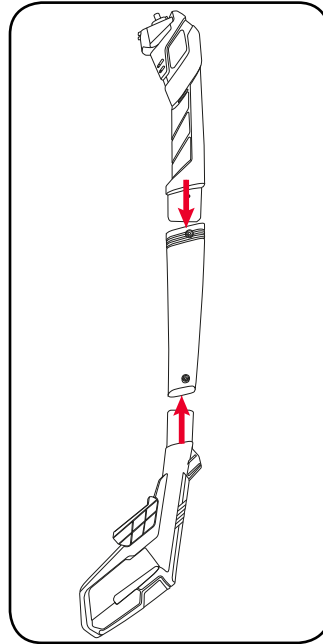

Fitting the Safety Guard

1. Turn the grass trimmer upside down. Align the tabs of the safety guard with the recess in the cutter head.

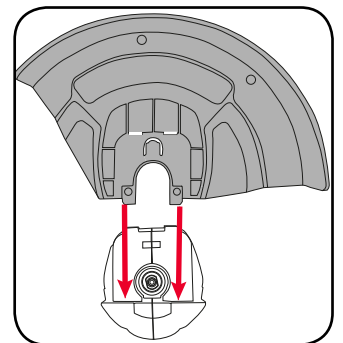

2. Slide in until it clicks into place.

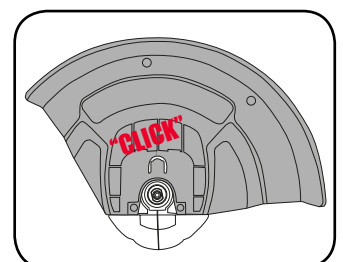

5 YEAR
REPLACEMENT WARRANTY

Fitting the Spindle Plate

1. Place the spindle plate onto the spindle and secure in place with the screw provided.

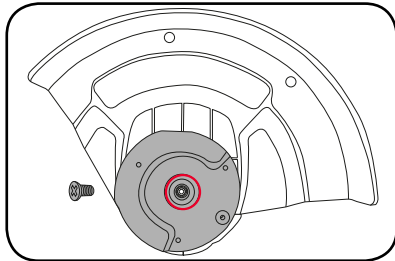

WARNING! NEVER USE THE GRASS TRIMMER UNLESS THE SAFETY GUARD IS PROPERLY FITTED.

Fitting the Secondary Handle

1. Align the recess in the secondary handle with the housing assembly..

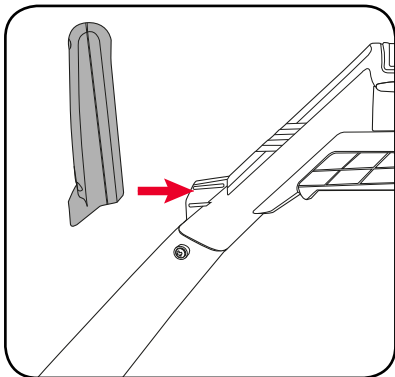

2. Slide in until it clicks into place.

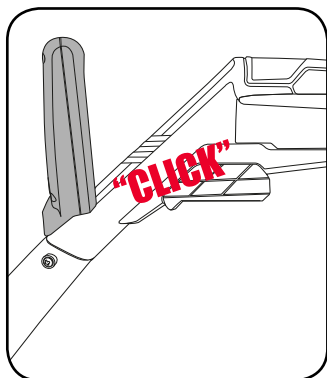

Attaching a Blade

1. Place the big hole in the blade onto the blade mount on the bottom of the spindle plate.

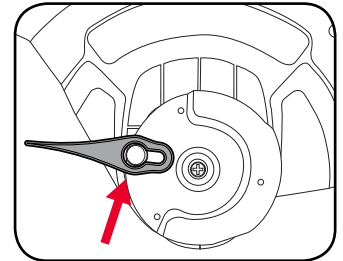

2. Pull the blade outwards so that the small hole is fitted into the mount.

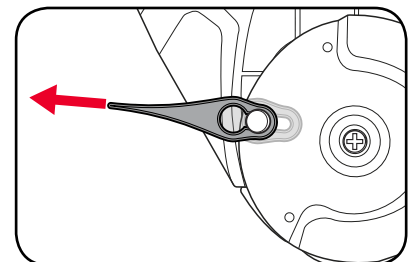

3. To remove the blade push the blade towards the centre of the spindle and then slide off.

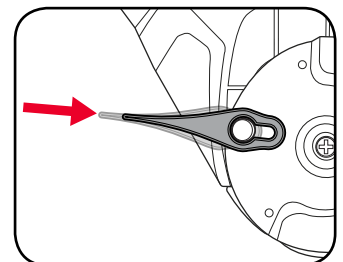

OPERATION

4. CONTROLS & OPERATION

Inserting & Removing the Battery

1. Align the ribs of the battery with the recess in below the handle and slide in until it clicks into place.

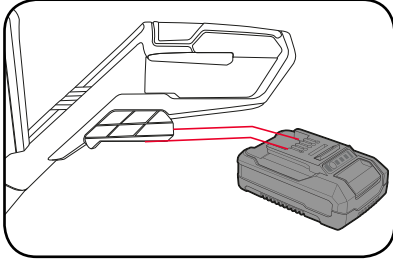

2. To remove, press and hold the battery release tab and then slide out.

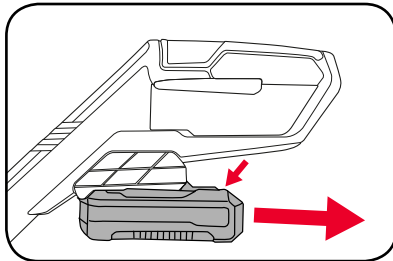

Switching On and Off

CAUTION! BEFORE YOU START THE UNIT, MAKE SURE THAT THE GRASS TRIMMER IS NOT MAKING CONTACT WITH ANY OBJECTS.

1. Squeeze the on/off trigger to start the trimmer.

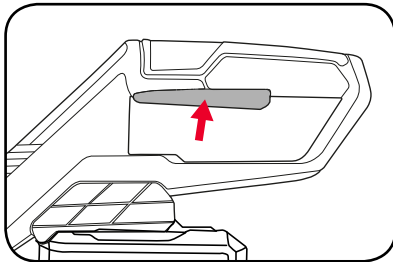

2. To stop the trimmer, release the On/Off trigger.

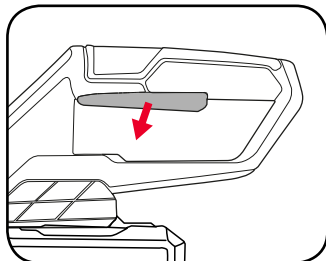

WARNING! DO NOT OPERATE THE TRIMMER ON A TREE, ON A LADDER, OR ON A SCAFFOLD, THIS IS EXTREMELY DANGEROUS.



WARNING! STONES, PIECES OF METAL AND OTHER OBJECTS CAN BE THROWN OUT AT HIGH SPEED BY THE BLADE.

Using the Grass Trimmer



WARNING! INSPECT THE AREA TO BE TRIMMED AND REMOVE ANY WIRE, CORD OR STRING-LIKE OBJECTS WHICH COULD BECOME ENTANGLED IN THE ROTATING BLADE.

- Hold the trimmer with both handles for best control and balance.
- Several passes will be required to cut long grass.

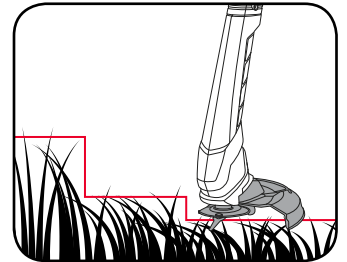
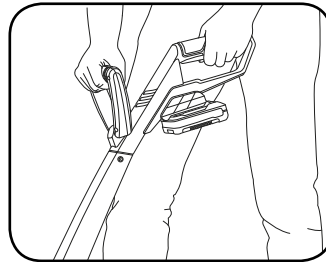

- Move the grass trimmer from side to side as you walk forward, holding it at an angle of approx. 30° (Light cuts are better than heavy cuts as they allow the cut grass to fall away from the cutting head).

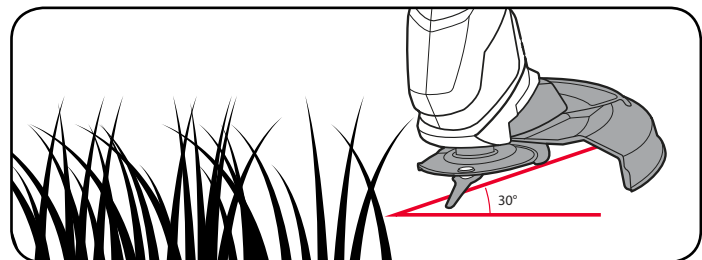
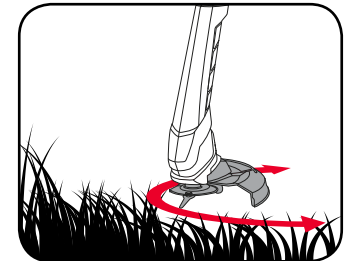

- When finished, release the on/off trigger and allow the motor to come to a complete standstill.

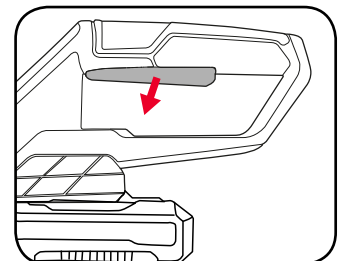

NOTE: DO NOT CUT GRASS WHEN WET. (THE BEST RESULTS ARE ACHIEVED ON DRY GRASS.)

CAUTION! BYSTANDERS MUST KEEP A MINIMUM SAFE DISTANCE OF 10M AWAY FROM THE TRIMMER WHILE IT IS OPERATING.

TROUBLESHOOTING

Problem	Cause	Remedy
Trimmer is not starting	Possible clogging	Clean the cutter head of any grass.
	Battery is low in charge	Charge battery
	Battery not inserted properly	Insert battery pack correctly
Trimmer is not operating at full capacity	Possible clogging	Clean the cutter head of any grass.
	Cutting tall grass at ground level.	Make several passes from top down.
Motor stops while operating	Battery has no power	Charge battery
Grass wraps around the shaft and trimmer head.	Cutting tall grass at ground level.	Make several passes from top down.

MAINTENANCE

- Keep ventilation slots of the trimmer clean at all times. Periodically clean out the grass from the cutting head and the rim of the blade guard to ensure efficient operation at all times.
- After each use, blow air through the tool housing to ensure it is free from all dust, dirt, etc. Buildup of dust, dirt particles may cause the tool to overheat and shorten the life of the tool.
- If the housing of the trimmer requires cleaning, do not use solvents but a moist soft cloth or soft brush only.
- Never let any liquid get inside the tool, never immerse any part of the tool into liquid.
- No lubrication is necessary as the tool has sealed bearings.
- When not in use, the grass trimmer should be stored in a dry, frost free location not within the reach of children.

Note: Ozito Industries will not be responsible for any damage or injuries caused by the repair of the grass trimmer by an unauthorised person or by mishandling of the grass trimmer. This tool is designed for DIY use - use in commercial or industrial environments will void the warranty.

CARING FOR THE ENVIRONMENT



Power tools that are no longer usable should not be disposed of with household waste but in an environmentally friendly way. Please recycle where facilities exist. Check with your local council authority for recycling advice.



Recycling packaging reduces the need for landfill and raw materials. Reuse of recycled material decreases pollution in the environment. Please recycle packaging where facilities exist. Check with your local council authority for recycling advice.



BATTERY AND CHARGER SAFETY WARNINGS

THIS MANUAL CONTAINS IMPORTANT SAFETY AND OPERATING INSTRUCTIONS FOR YOUR BATTERY CHARGER.

1. Before using the charger read all instructions and cautionary markings on the charger, battery pack and the product using the battery pack.
2. This charger is not intended for any uses other than charging rechargeable batteries. Any other use may result in risk of fire, electric shock or electrocution.
3. Do not place any object on top of the charger or place the charger on a soft surface that may result in excessive internal heat. Place the charger in a position away from any heat source.
4. To reduce risk of damage to the electric plug and cord, pull by the plug rather than the cord when disconnecting the charger.
5. Make sure the cord is located so that it will not be stepped on, tripped over, or otherwise subjected to damage or stress.
6. An extension cord should not be used unless absolutely necessary. Use of an improper extension cord could result in the risk of fire, electric shock or electrocution.
7. Do not operate the charger if it has received a sharp blow, been dropped or otherwise damaged in any way. Have it checked by an electrician or power tool repairer.
8. Do not disassemble charger. Take it to an electrician or power tool repairer when service or repair is required. Incorrect reassembly may result in a risk of electric shock, electrocution or fire.
9. To reduce risk of electric shock, unplug the charger from the outlet before attempting any cleaning. Removing the battery pack will not reduce this risk.
10. Never attempt to connect 2 chargers together.
11. DO NOT store or use the tool and battery pack in locations where the temperature may reach or exceed 40°C (such as inside sheds or metal buildings in summer).
12. The charger is designed to operate on standard household electrical power (240 volts). Do not attempt to use it on any other voltage!
13. The battery pack is not fully charged out of the carton. First read the safety instructions and then follow the charging notes and procedures.
14. The longest life and best performance can be obtained if the battery pack is charged when the air temperature is between 18 - 24°C. Do not charge the battery pack in an air temperature below 10°C or above 40°C. This is important and will prevent damage to the battery pack.
15. Do not incinerate the battery pack even if it is seriously damaged or is completely worn out. The battery can explode in a fire.
16. Never attempt to open the battery pack for any reason. If the plastic housing of the battery pack breaks or cracks, immediately discontinue use and do not recharge.
17. During charging, the battery must be placed in a well ventilated area.

DESCRIPTION OF SYMBOLS

	Volts		Hertz
	Alternating current		Watts
	Direct current		Diameter
	Milliamperes		No load speed
	Revolutions or reciprocation per minute		Regulator compliance mark
	Warning!		Decibel level
	Read instruction manual		Wear goggles and ear muffs
	Do not use in the rain or leave the grass trimmer outdoors while raining		
	Keep all other persons away from the danger zone.		
	The equipment continues to rotate!		

SPARE PARTS

Spare parts can be ordered from the Special Orders Desk at your local Bunnings Warehouse.

For further information, or any parts not listed here, visit www.ozito.com.au or contact Ozito Customer Service:

Australia 1800 069 486

New Zealand 0508 069 486

E-mail: enquiries@ozito.com.au



ELECTRICAL SAFETY



WARNING! When using mains-powered tools, basic safety precautions, including the following, should always be followed to reduce risk of fire, electric shock, personal injury and material damage.

Read the whole manual carefully and make sure you know how to switch the tool off in an emergency, before operating the tool. Save these instructions and other documents supplied with this tool for future reference.

The charger has been designed for 230V and 240V only. Always check that the power supply corresponds to the voltage on the rating plate.

Note: The supply of 230V and 240V on Ozito tools are interchangeable for Australia and New Zealand.



This tool's charger is double insulated therefore no earth wire is required.

If the supply cord is damaged, it must be replaced by an electrician or a power tool repairer in order to avoid a hazard.

Note: Double insulation does not take the place of normal safety precautions when operating this tool. The insulation system is for added protection against injury resulting from a possible electrical insulation failure within the tool.

Using an Extension Lead

Always use an approved extension lead suitable for the power input of this tool. Before use, inspect the extension lead for signs of damage, wear and ageing. Replace the extension lead if damaged or defective.

When using an extension lead on a reel, always unwind the lead completely. Use of an extension lead not suitable for the power input of the tool or which is damaged or defective may result in a risk of fire and electric shock.

The power supply for this product's charger should be protected by a residual current device (rated at 30mA or less). A residual current device reduces the risk of electric shock.



GENERAL POWER TOOL SAFETY WARNINGS



WARNING! Read all safety warnings and all instructions. Failure to follow the warnings and instructions may result in electric shock, fire and/or serious injury.

Save all warnings and instructions for future reference. The term "power tool" in the warnings refers to your mains-operated (corded) power tool or battery-operated (cordless) power tool.

1. Work area safety

- Keep work area clean and well lit.** Cluttered or dark areas invite accidents.
- Do not operate power tools in explosive atmospheres, such as in the presence of flammable liquids, gases or dust.** Power tools create sparks which may ignite the dust or fumes.
- Keep children and bystanders away while operating a power tool.** Distractions can cause you to lose control.

2. Electrical safety

- Power tool plugs must match the outlet. Never modify the plug in any way. Do not use any adapter plugs with earthed (grounded) power tools.** Unmodified plugs and matching outlets will reduce risk of electric shock.
- Avoid body contact with earthed or grounded surfaces, such as pipes, radiators, ranges and refrigerators.** There is an increased risk of electric shock if your body is earthed or grounded.
- Do not expose power tools to rain or wet conditions.** Water entering a power tool will increase the risk of electric shock.
- Do not abuse the cord. Never use the cord for carrying, pulling or unplugging the power tool. Keep cord away from heat, oil, sharp edges or moving parts.** Damaged or entangled cords increase the risk of electric shock.
- When operating a power tool outdoors, use an extension cord suitable for outdoor use.** Use of a cord suitable for outdoor use reduces the risk of electric shock.
- If operating a power tool in a damp location is unavoidable, use a residual current device (RCD) protected supply.** Use of an RCD reduces the risk of electric shock.

3. Personal safety

- Stay alert, watch what you are doing and use common sense when operating a power tool. Do not use a power tool while you are tired or under the influence of drugs, alcohol or medication.** A moment of inattention while operating power tools may result in serious personal injury.
- Use personal protective equipment. Always wear eye protection.** Protective equipment such as dust mask, non-skid safety shoes, hard hat, or hearing protection used for appropriate conditions will reduce personal injuries.
- Prevent unintentional starting. Ensure the switch is in the off-position before connecting to power source and/or battery pack, picking up or carrying the tool.** Carrying power tools with your finger on the switch or energising power tools that have the switch on invites accidents.
- Remove any adjusting key or wrench before turning the power tool on.** A wrench or a key left attached to a rotating part of the power tool may result in personal injury.
- Do not overreach. Keep proper footing and balance at all times.** This enables better control of the power tool in unexpected situations.

- Dress properly. Do not wear loose clothing or jewellery. Keep your hair, clothing and gloves away from moving parts.** Loose clothes, jewellery or long hair can be caught in moving parts.
- If devices are provided for the connection of dust extraction and collection facilities, ensure these are connected and properly used.** Use of dust collection can reduce dust-related hazards.

4. Power tool use and care

- Do not force the power tool. Use the correct power tool for your application.** The correct power tool will do the job better and safer at the rate for which it was designed.
- Do not use the power tool if the switch does not turn it on and off.** Any power tool that cannot be controlled with the switch is dangerous and must be repaired.
- Disconnect the plug from the power source and/or the battery pack from the power tool before making any adjustments, changing accessories, or storing power tools.** Such preventive safety measures reduce the risk of starting the power tool accidentally.
- Store idle power tools out of the reach of children and do not allow persons unfamiliar with the power tool or these instructions to operate the power tool.** Power tools are dangerous in the hands of untrained users.
- Maintain power tools. Check for misalignment or binding of moving parts, breakage of parts and any other condition that may affect the power tool's operation. If damaged, have the power tool repaired before use.** Many accidents are caused by poorly maintained power tools.
- Keep cutting tools sharp and clean.** Properly maintained cutting tools with sharp cutting edges are less likely to bind and are easier to control.
- Use the power tool, accessories and tool bits etc. in accordance with these instructions, taking into account the working conditions and the work to be performed.** Use of the power tool for operations different from those intended could result in a hazardous situation.

5. Battery tool use and care

- Recharge only with the charger specified by the manufacturer.** A charger that is suitable for one type of battery pack may create a risk of fire when used with another battery pack.
- Use power tools only with specifically designated battery packs.** Use of any other battery packs may create a risk of injury and fire.
- When battery pack is not in use, keep it away from other metal objects, like paper clips, coins, keys, nails, screws or other small metal objects, that can make a connection from one terminal to another.** Shorting the battery terminals together may cause burns or a fire.
- Under abusive conditions, liquid may be ejected from the battery; avoid contact. If contact accidentally occurs, flush with water. If liquid contacts eyes, additionally seek medical help.** Liquid ejected from the battery may cause irritation or burns.

6. Service

- Have your power tool serviced by a qualified repair person using only identical replacement parts.** This will ensure that the safety of the power tool is maintained.



GRASS TRIMMER SAFETY WARNINGS

Hold power tool by insulated gripping surfaces, when performing an operation where the cutting accessory may contact hidden wiring. Cutting accessory contacting a "live" wire may make exposed metal parts of the power tool "live" and could give the operator an electric shock.

This appliance is not intended for use by persons (including children) with reduced physical, sensory or mental capabilities, or lack of experience and knowledge, unless they have been given supervision or instruction concerning use of the appliance by a person responsible for their safety.

- Never allow children or people unfamiliar with these instructions to use the grass trimmer.
- Avoid using the grass trimmer, while people, especially children or pets, are nearby.
- Use the grass trimmer only in daylight or good artificial light.
- Never operate the grass trimmer with damaged guards or without guards in place.
- Switch on the grass trimmer only when the hands and feet are away from the cutting head.
- Never fit metal cutting blades.
- Use only the manufacturer's recommended replacement parts and accessories.
- Always remove the battery from the grass trimmer when leaving the grass trimmer unattended.
- Always remove the battery from the grass trimmer before carrying out maintenance or cleaning work.

- Inspect and maintain the grass trimmer regularly. Have the grass trimmer repaired only by an authorized repairer.
- When not in use, store the grass trimmer out of the reach of children.
- Face the cutting head away from yourself, other people and animals while the power is connected to the grass trimmer (especially during operation).
- Remove the battery when changing spools or clearing grass from under the guard.
- Remove the battery from the grass trimmer before making any adjustments.
- Use both handles at all times
- Keep ventilation openings clear of debris. Keep handles dry, clean and free of oil and grease.
- Never reach underneath the grass trimmer (the cutting blade area) until it has completely stopped and the battery has been removed.



WARNING! When servicing, use only identical replacement parts. Use of any other parts may create a hazard or cause product damage. To ensure safety and reliability, all repairs should be performed by a qualified service technician.



WARNING! This appliance is not intended for use by young or infirm persons unless supervised by a responsible person to ensure that they can use the appliance safely. Children should be supervised to ensure that they do not play with the appliance.