

Ezy-Fit D.I.Y Custom Made Roller Shutters Order Form



Customer Name: _____ Phone: (_____)
 Customer's Delivery Address: _____ Mobile: _____
 Suburb: _____ State: _____ Postcode: _____

* Measure instructions are required to complete order form correctly *
 available from EzyFitRollershutters.com.au or the Special Orders Desk

1. Roller shutter no. 1 Area Name: 2. Wall type: <input type="checkbox"/> Brick / Precast Concrete <input type="checkbox"/> Weatherboard / Cladding <input type="checkbox"/> Rendered Blueboard <input type="checkbox"/> Rendered Foam 3. Window type: <input type="checkbox"/> Double-hung <input type="checkbox"/> Awning <input type="checkbox"/> Sliding <input type="checkbox"/> Casement <input type="checkbox"/> Fixed <input type="checkbox"/> Hopper 4. Installation: <input type="checkbox"/> In-Reveal <input type="checkbox"/> Face-Fit 5. Measurements: Height (mm) ↓ <table border="1" style="width: 100px;"><tr><td> </td><td> </td><td> </td><td> </td></tr></table> Width (mm) ←→ <table border="1" style="width: 100px;"><tr><td> </td><td> </td><td> </td><td> </td></tr></table> 6. Clearance above opening: Distance (mm) <table border="1" style="width: 100px;"><tr><td> </td><td> </td><td> </td><td> </td></tr></table> 7. Packing profile (Face-fit only) <input type="checkbox"/> <input type="checkbox"/> 12 <input type="checkbox"/> 15 <input type="checkbox"/> 20 <input type="checkbox"/> 25 <input type="checkbox"/> 30 <input type="checkbox"/> 38 <input type="checkbox"/> 45 8. Sill angle: <input checked="" type="checkbox"/> <input type="checkbox"/> Sill required 9. Drive type: <input type="checkbox"/> AC Electric Motor <input type="checkbox"/> DC Battery Motor 10. Control side: <input type="checkbox"/> Left <input type="checkbox"/> Right 11. Colour: Slats: Pelmet/Guides: 12. AC Electric Motor - Optional extras (Available at an additional cost) <input type="checkbox"/> Remote Control <input type="checkbox"/> Battery Backup													1. Roller shutter no. 2 Area Name: 2. Wall type: <input type="checkbox"/> Brick / Precast Concrete <input type="checkbox"/> Weatherboard / Cladding <input type="checkbox"/> Rendered Blueboard <input type="checkbox"/> Rendered Foam 3. Window type: <input type="checkbox"/> Double-hung <input type="checkbox"/> Awning <input type="checkbox"/> Sliding <input type="checkbox"/> Casement <input type="checkbox"/> Fixed <input type="checkbox"/> Hopper 4. Installation: <input type="checkbox"/> In-Reveal <input type="checkbox"/> Face-Fit 5. Measurements: Height (mm) ↓ <table border="1" style="width: 100px;"><tr><td> </td><td> </td><td> </td><td> </td></tr></table> Width (mm) ←→ <table border="1" style="width: 100px;"><tr><td> </td><td> </td><td> </td><td> </td></tr></table> 6. Clearance above opening: Distance (mm) <table border="1" style="width: 100px;"><tr><td> </td><td> </td><td> </td><td> </td></tr></table> 7. Packing profile (Face-fit only) <input type="checkbox"/> <input type="checkbox"/> 12 <input type="checkbox"/> 15 <input type="checkbox"/> 20 <input type="checkbox"/> 25 <input type="checkbox"/> 30 <input type="checkbox"/> 38 <input type="checkbox"/> 45 8. Sill angle: <input checked="" type="checkbox"/> <input type="checkbox"/> Sill required 9. Drive type: <input type="checkbox"/> AC Electric Motor <input type="checkbox"/> DC Battery Motor 10. Control side: <input type="checkbox"/> Left <input type="checkbox"/> Right 11. Colour: Slats: Pelmet/Guides: 12. AC Electric Motor - Optional extras (Available at an additional cost) <input type="checkbox"/> Remote Control <input type="checkbox"/> Battery Backup													1. Roller shutter no. 3 Area Name: 2. Wall type: <input type="checkbox"/> Brick / Precast Concrete <input type="checkbox"/> Weatherboard / Cladding <input type="checkbox"/> Rendered Blueboard <input type="checkbox"/> Rendered Foam 3. Window type: <input type="checkbox"/> Double-hung <input type="checkbox"/> Awning <input type="checkbox"/> Sliding <input type="checkbox"/> Casement <input type="checkbox"/> Fixed <input type="checkbox"/> Hopper 4. Installation: <input type="checkbox"/> In-Reveal <input type="checkbox"/> Face-Fit 5. Measurements: Height (mm) ↓ <table border="1" style="width: 100px;"><tr><td> </td><td> </td><td> </td><td> </td></tr></table> Width (mm) ←→ <table border="1" style="width: 100px;"><tr><td> </td><td> </td><td> </td><td> </td></tr></table> 6. Clearance above opening: Distance (mm) <table border="1" style="width: 100px;"><tr><td> </td><td> </td><td> </td><td> </td></tr></table> 7. Packing profile (Face-fit only) <input type="checkbox"/> <input type="checkbox"/> 12 <input type="checkbox"/> 15 <input type="checkbox"/> 20 <input type="checkbox"/> 25 <input type="checkbox"/> 30 <input type="checkbox"/> 38 <input type="checkbox"/> 45 8. Sill angle: <input checked="" type="checkbox"/> <input type="checkbox"/> Sill required 9. Drive type: <input type="checkbox"/> AC Electric Motor <input type="checkbox"/> DC Battery Motor 10. Control side: <input type="checkbox"/> Left <input type="checkbox"/> Right 11. Colour: Slats: Pelmet/Guides: 12. AC Electric Motor - Optional extras (Available at an additional cost) <input type="checkbox"/> Remote Control <input type="checkbox"/> Battery Backup												

Special Orders Team Member to Complete

Order Summary				
Description	Item Number	Item Price	Qty	Item Total
Total Price (including GST)				

By signing this order form I am confirming that I have utilised the measure instructions and the measurements are correct. The order is final and once the roller shutters are manufactured no changes can be made.

Customer Signature:
 Date:/...../.....

Team Member Name:
 CSO Number:

Store:
 Fax Number: (03) 9808 0466



It's so easy...



Measure Instructions

Introduction

This document provides a step-by-step guide on how to measure, and complete the order form for Ezy-Fit D.I.Y Roller Shutters.

Tools required: tape measure

Table of Contents

Page No.

2	Introduction
2	Table of Contents
3	Step 1: Area name
3	Step 2: Identify Wall Type
4	Step 3: Identify Window Type
5	Step 4: Select your Installation type
6	Step 5: Measurement
8	Step 6: Face-Fit Installation, Clearance above the opening
8	Step 6: Face-Fit Installation, Packing Profile
9	Step 8: Sill Angle
10	Step 9: Drive Type
10	Step 10: Select Control Side
11	Step 11: Select Colours
11	Step 12: Optional Extras
12	Order Form

Step 1: Area name

Firstly, choose a name or description for each roller shutter you plan to order.

We will use your name or description on the roller shutter packs you receive, to help you identify and install them in the right place.

Example: master bedroom, sitting room, kitchen, bedroom 1, bedroom 2, etc.

Order form sample:

1. Roller shutter no. 1
Area Name: ..**Master..bedroom**....

Step 2: Identify Wall Type



Note: Some of these wall types can have a rendered finish, making it hard to determine the type. Consult your builder if you are unsure about the construction.

Order form sample:

2. Wall type:
 Brick / Precast Concrete
 Weatherboard / Cladding
 Rendered Blueboard
 Rendered Foam

Brick / Precast Concrete

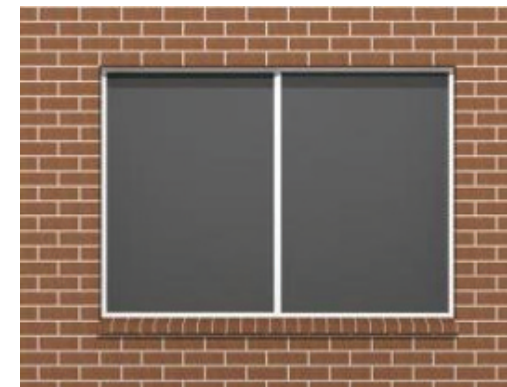

Weatherboard / Cladding



Rendered blueboard

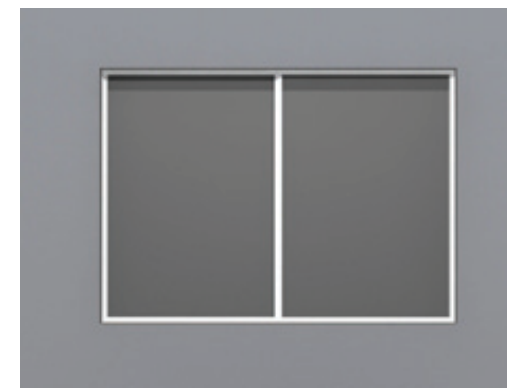

Rendered Foam

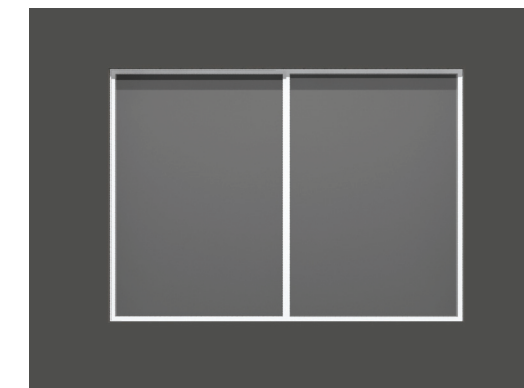

Step 3: Identify Window Type

Order form sample:

3. Window type:	
<input type="checkbox"/> Double-hung	<input type="checkbox"/> Awning
<input checked="" type="checkbox"/> Sliding	<input type="checkbox"/> Casement
<input type="checkbox"/> Fixed	<input type="checkbox"/> Hopper

Double-hung



Sliding



Fixed



Awning



Casement



Hopper



Step 4: Select your Installation type

In-Reveal:

- Suitable only for: Brick and Concrete walls with Sliding, Double-hung, and Fixed windows
- Requires a minimum of 22 mm inside the window opening to secure the shutter guides
- The roller shutter is positioned inside the window opening
- The size of the roller shutter in this method is dictated by the size of the opening
- This is a better choice for those who want a more integrated finish to the look of their roller shutters



Order form sample:

4. Installation:	
<input checked="" type="checkbox"/> In-Reveal	<input type="checkbox"/> Face-Fit

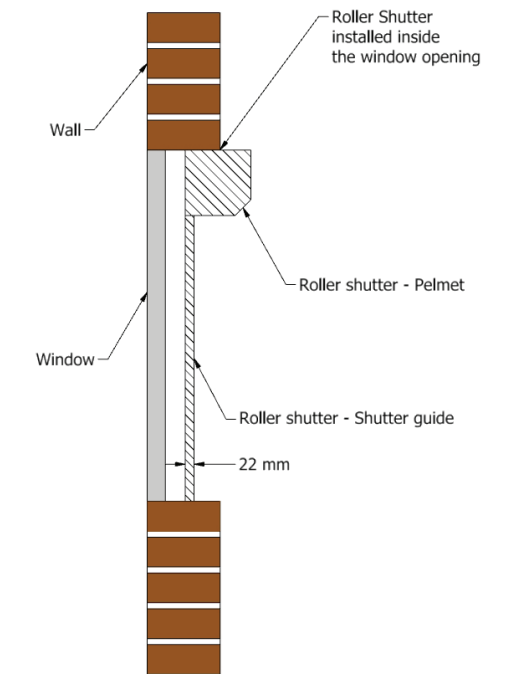

Face-Fit:

- This is suitable for all wall and window types
- The roller shutter is positioned on the face of the wall and around the window opening
- This is more flexible and suitable for completely 'out of square' window openings



Order form sample:

4. Installation:	
<input type="checkbox"/> In-Reveal	<input checked="" type="checkbox"/> Face-Fit

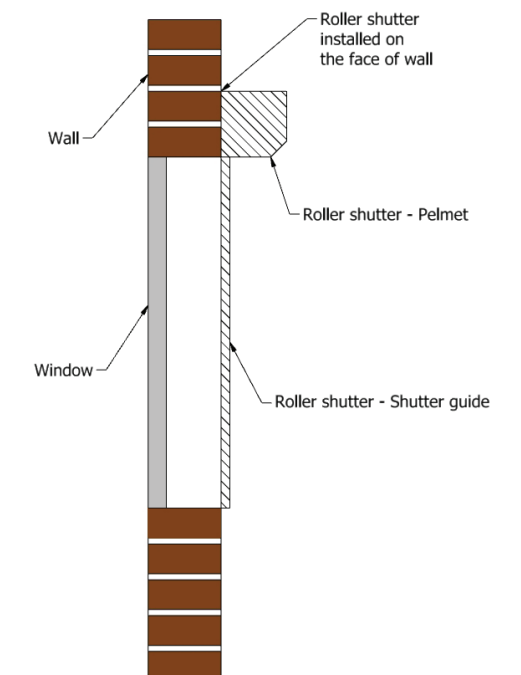

Step 5: Measurement

In-Reveal Measurement: Height

(a) Measure the **height** from top of the opening to the sill in two different points: left and right

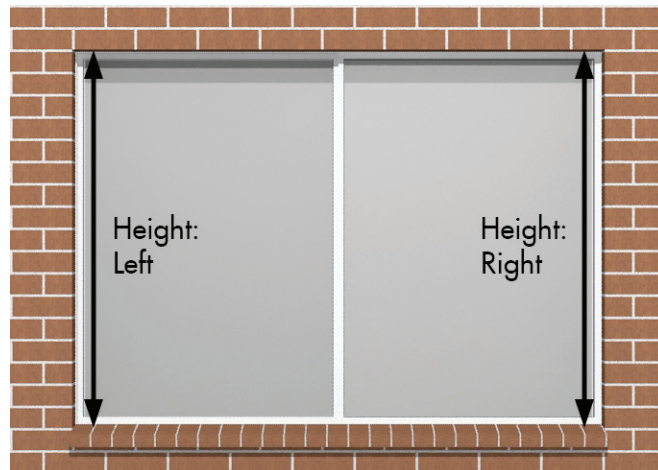

Use the smaller of the two as the final measurement.

Example: Measured height in 2 points:
Left: 1200 mm, Right: 1203 mm
Height = 1200 mm

Order form sample:

5. Measurements:				
Height (mm) ↕	1	2	0	0
Width (mm) ↔				

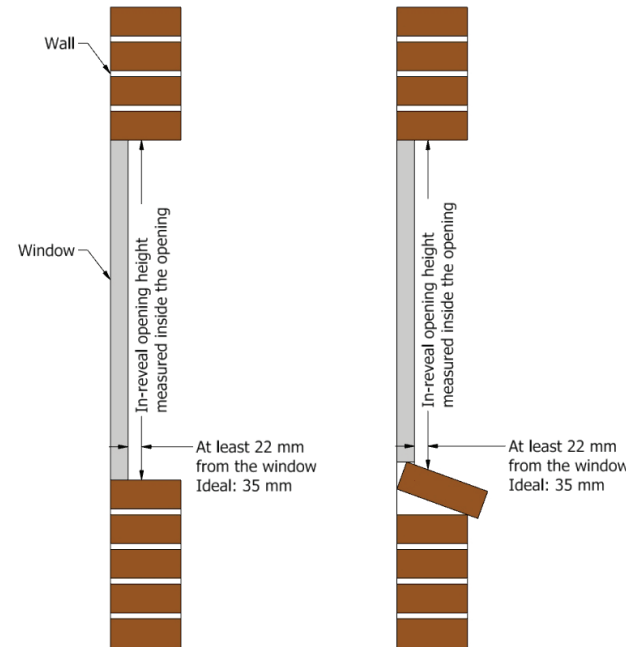

Please note that the minimum width of the opening for in-reveal installation is **500 mm** and the maximum is **3200 mm**.

Width

(b) Measure the **width** in three different points: top, middle, and bottom

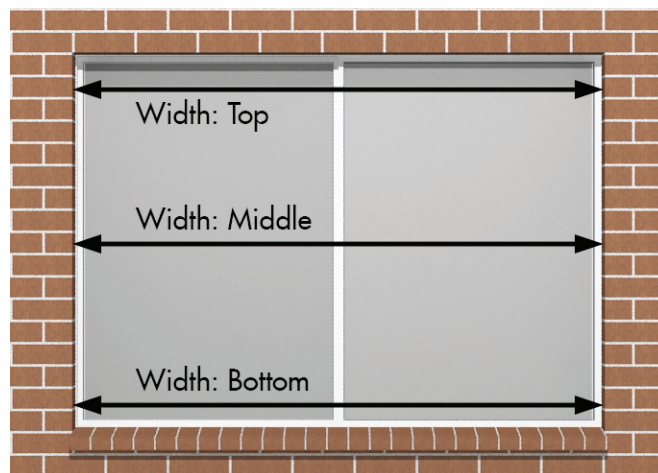

Use the smallest of the three as the final measurement.

Example: Measured width in 3 points:
Top: 1500 mm, Middle: 1503 mm,
Bottom: 1505 mm Width = 1500 mm

Order form sample:

5. Measurements:				
Height (mm) ↕	1	2	0	0
Width (mm) ↔	1	5	0	0

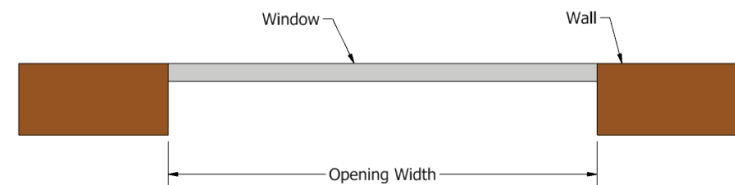

Please note that the minimum height of the opening for in-reveal installation is **400 mm** and the maximum is **3200 mm**.

(c) Go to Step 8: Sill angle

Face-Fit Measurement: Height

(a) Measure the **height** from top of the opening to the sill in two different points: left and right

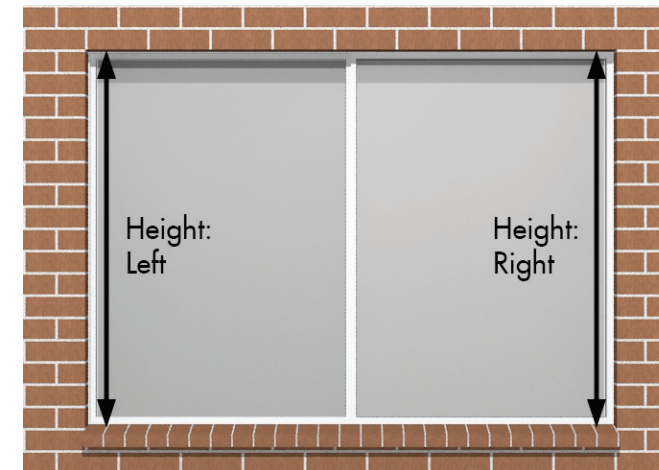

Use the bigger of the two as the final measurement.

Example: Measured height in 2 points:
Left: 1200 mm, Right: 1203 mm
Height = 1203 mm

Order form sample:

5. Measurements:				
Height (mm) ↕	1	2	0	3
Width (mm) ↔				

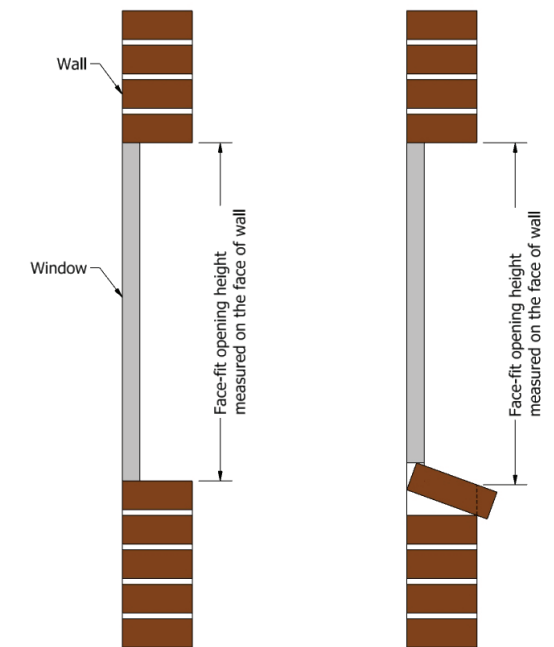

Please note that the minimum width of the opening for face-fit installation is **500 mm** and the maximum is **3100 mm**.

Width

(b) Measure the **width** in three different points: top, middle, and bottom

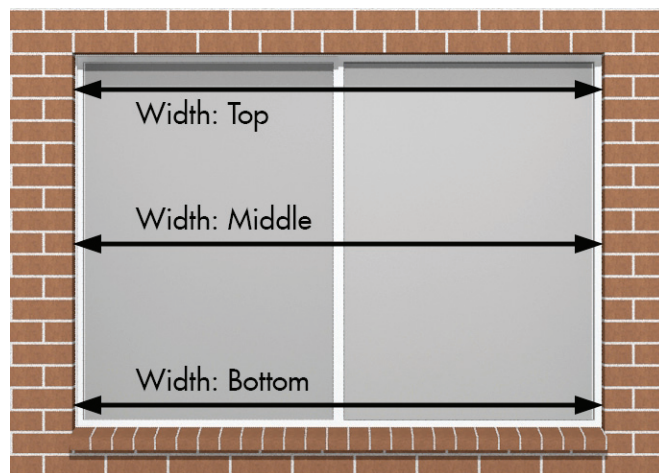

Use the biggest of the three as the final measurement.

Example: Measured width in 3 points:
Top: 1500 mm, Middle: 1503 mm, Bottom: 1505 mm
Opening Width = 1505 mm

Order form sample:

5. Measurements:				
Height (mm) ↕	1	2	0	3
Width (mm) ↔	1	5	0	5

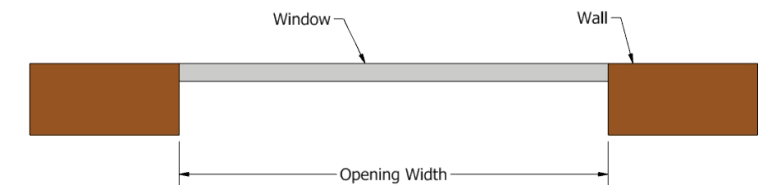

Please note that the minimum height of the opening for in-reveal installation is **400 mm** and the maximum is **3200 mm**.

Step 6: Face-Fit Installation, Clearance above the opening

If there is an obstruction (like eave, veranda, pergola, pipes, etc.) above the opening, measure the distance from top of the opening to the obstruction.

If the clearance is less than 300 mm, write the measured distance on the order form.

If the eave or the obstruction is at the same height as the top of the opening, put 000 mm on the order form.

Order form sample:

6. Clearance above opening:			
Distance (mm)	1	5	0

Order form sample:

6. Clearance above opening:			
Distance (mm)	0	0	0



Step 6: Face-Fit Installation, Packing Profile

In some cases, window frames or handles that protrude past the exterior wall can interfere with the operation of the shutter.

To solve this problem *Packing Profiles* are used to provide a gap between the roller shutter and the face of the exterior wall to clear the handle or window frame.

Order form sample:

7. Packing profile (Face-fit only)			
<input type="checkbox"/> 12	<input type="checkbox"/> 15	<input checked="" type="checkbox"/> 20	<input type="checkbox"/> 25
<input type="checkbox"/> 30	<input type="checkbox"/> 38	<input type="checkbox"/> 45	

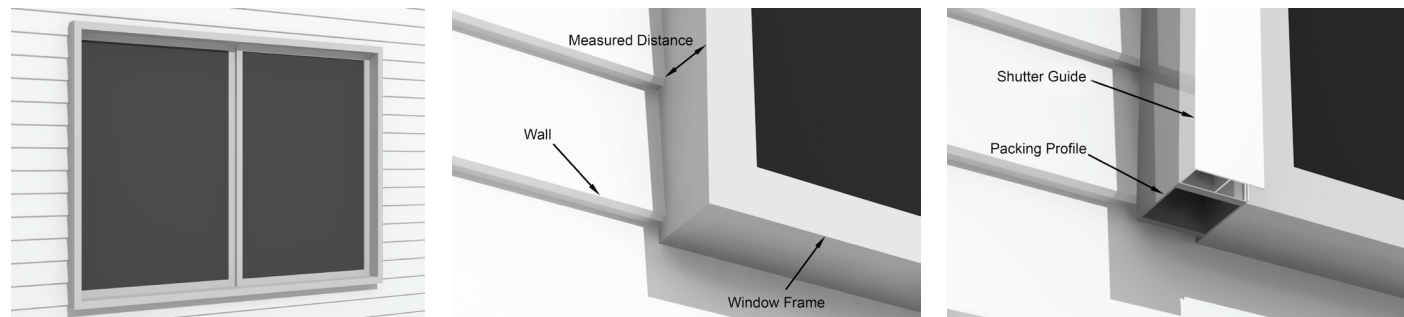

In this case, measure from the face of the wall to the window frame or handle and select the larger closest size on the order form.

Example: Measured distance: 18 mm
Select the 20 mm packer on the order form.

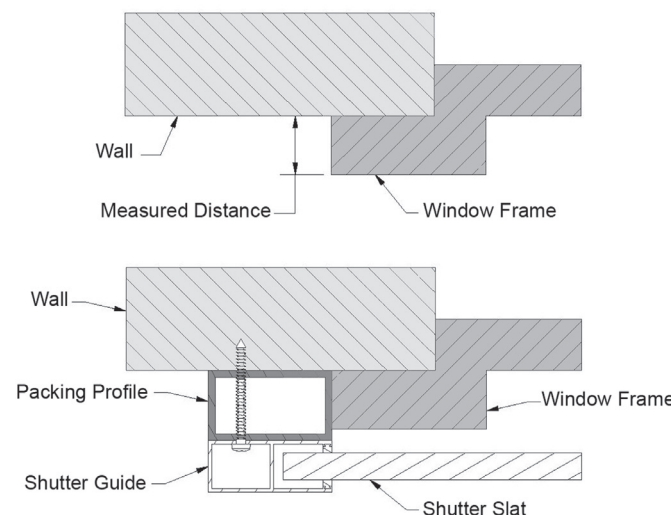

Step 8: Sill Angle

The window sill allows the roller shutter to sit and close upon it. If your windows don't have sills, you will need to use separate sill angles.

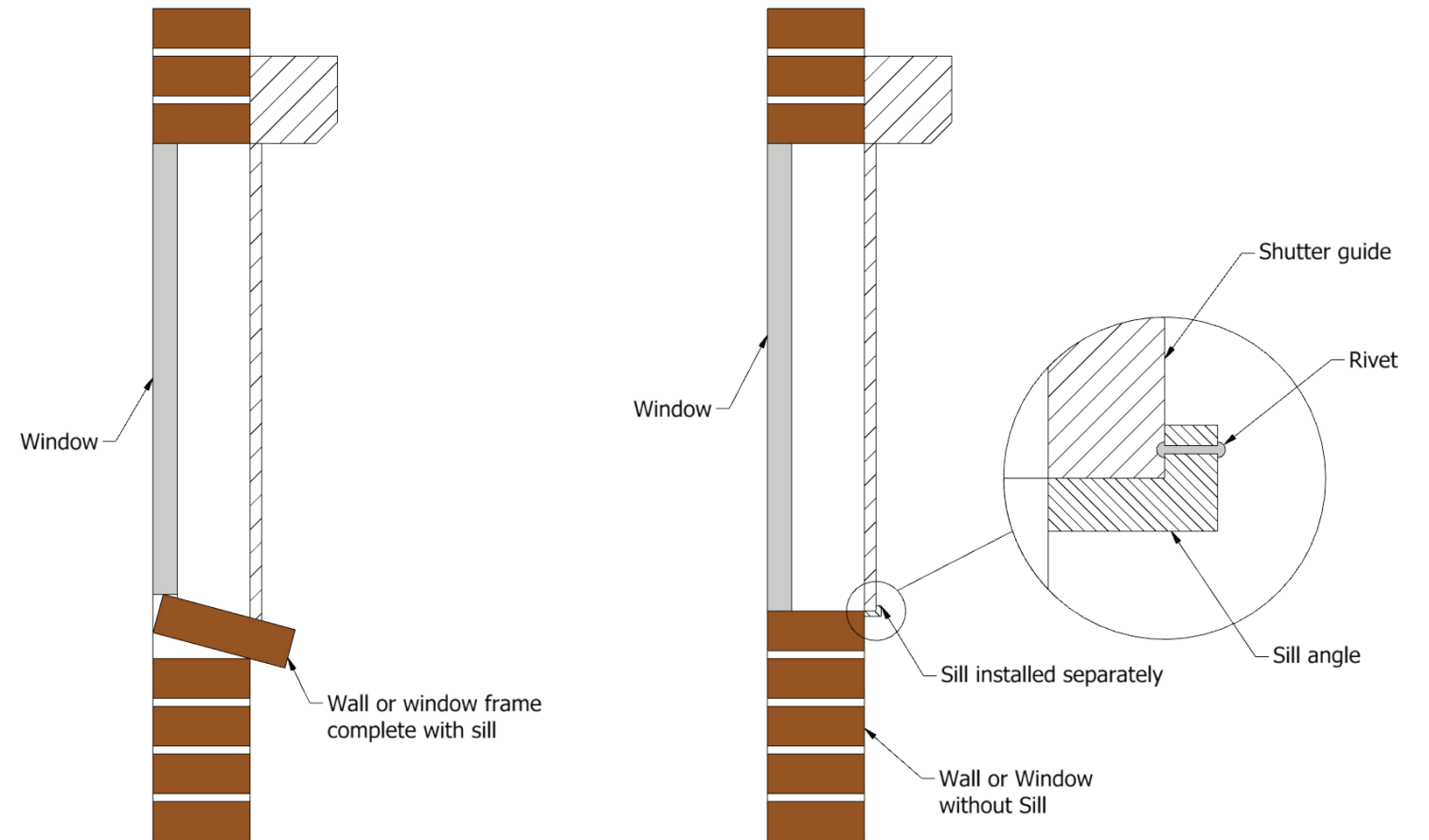

This type of wall shown below does not require a sill angle.

Order form sample:

8. Sill angle:	
<input type="checkbox"/> Sill required	

This type of wall shown below requires a sill angle.

Order form sample:

8. Sill angle:	
<input checked="" type="checkbox"/> Sill required	

Step 9: Drive Type

AC Electric Motors:

- Average lifespan of 15 to 17 years
- Choice of wall-mounted switches or remote controls
- Need a qualified electrician to do the wiring for you



Order form sample:

9. Drive type:
 AC Electric Motor
 DC Battery Motor

DC Battery Motor:

- Operates using a rechargeable handset as its power supply
- Handsets need to be recharged like a cell phone on average once every three weeks
- Average lifespan of the battery is two to four years
- Average lifespan of the motor is seven to nine years
- You can wire these motors yourself without requiring an electrician



Order form sample:

9. Drive type:
 AC Electric Motor
 DC Battery Motor

Step 10: Select Control Side

For AC Electric Motors, if you already have a switch or power point close to your window, it is better to choose the same side for installing the control switch as it makes the wiring easier. For DC Battery Motors it is personal preference to have the switch on either side of the window. The reference on the order form for left or right is when viewed from the **inside** of the house.

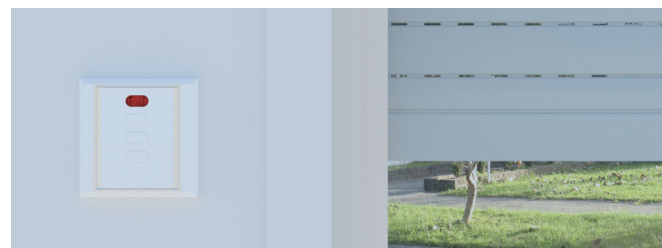

Left



Right

Order form sample:

10. Control side:
 Left Right

Order form sample:

10. Control side:
 Left Right

Step 11: Select Colours

Ezy-Fit Roller Shutters are available in 9 colours:

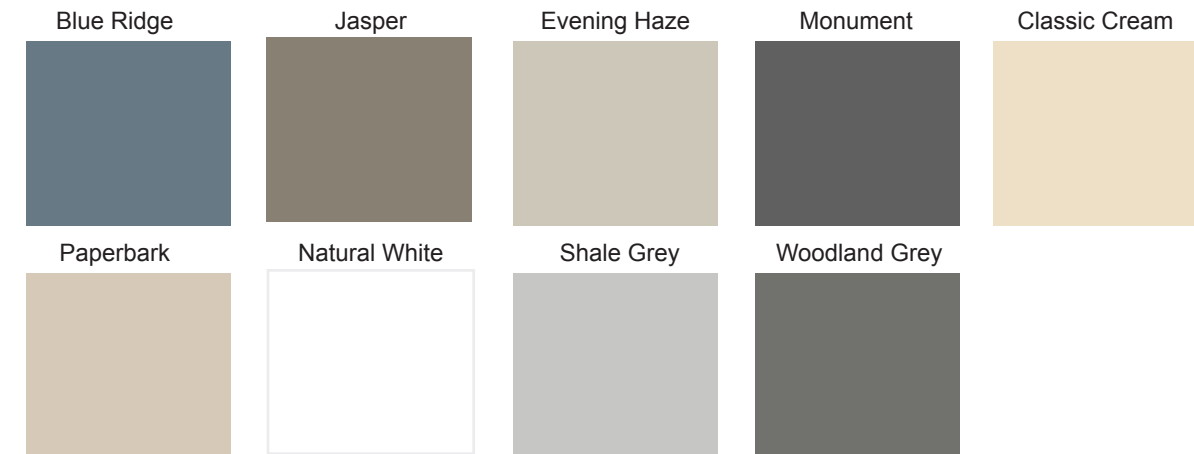

Colour samples are also available on the Ezy-Fit website and brochure where the display is located at your local Bunnings store, which will help you choose the colour of slats and shutter guides/pelmet.

Order form sample:

11. Colour:
 Slats: **Jasper**
 Pelmet/Guides: **Evening haze**

Step 12: Optional Extras



Remote Control for AC Electric Motors:

With the remote control, you can operate your shutters from your sofa or bed and can control your shutters in single or groups. If you have multiple roller shutters, you can master control all of the shutters at the touch of a button.

Order form sample:

12. AC Electric Motor - Optional extras (Available at an additional cost)
 Remote Control Battery Backup



Battery Backup (UPS) for AC Electric Motors:

The battery backup is beneficial in instances of electrical power loss. The shutters will still function for approximately eight cycles with the backup system. This is strongly recommended for **bedroom windows** to allow the roller shutters to operate as an emergency exit.

Order form sample:

12. AC Electric Motor - Optional extras (Available at an additional cost)
 Remote Control Battery Backup

