

External Tiling Application Guide

EasyLap™ panel



James Hardie
A smarter way to build

AUSTRALIA AUGUST 2014

CONTENTS

1	INTRODUCTION	2
	EasyLap™ panel sizes	3
	Accessories/tools supplied by James Hardie	3
	Accessories/tools not supplied by James Hardie	3
2	SAFE WORKING PRACTICES	4
	Warning	4
	Recommended safe working practices	4
	Storage and handling	4
3	DESIGN / FRAMING	4
	Scope	4
	Design	4
	Framing	5
4	PREPARATION AND FASTENERS	6
	Preparation	6
	Fasteners	6
	Sheet Installation	6
5	DETAILS	8
	External Corner Details	8
	Internal Corner Details	8
	Junction Details	8
6	WATERPROOFING SYSTEM AND TILING	10
	Waterproofing System	10
	Tile Adhesive	10
	Maintenance	10
7	PRODUCT INFORMATION	10
8	WARRANTY	11

1 INTRODUCTION

This is an application guide for tiling over EasyLap™ panels on a wall as a part of a residential building. The EasyLap™ panel installation guide is to be read in conjunction with this application guide.

The James Hardie EasyLap™ panel is a fibre cement base sheet with a shi lap vertical joint, that can be used as a substrate for an external tiled wall application as part of a residential building.

This guide is restricted to:

- 1) a maximum tile weight of 50kg/m²;
- 2) a maximum AS 4055 wind classification of N3/C1;
- 3) a maximum wall height of 6m from ground level;
- 4) maximum 450mm stud centres;
- 5) sheet joins and edges must be fully supported on studs;
- 6) using screw fixing only.

These guidelines are for an external tiling application which consists of two components:

- 1) The James Hardie EasyLap™ panel as the tiling substrate; and
- 2) The waterproofing and tile fixing supplied and warranted by third party companies (refer to section 6 of this manual for more information).

For the James Hardie product warranty to apply, it is mandatory to apply a full waterproofing system (primer and waterproof membrane) over the EasyLap™ panels prior to tiling externally regardless of tiling manufacturer's recommendations.

EasyLap™ panels must not be used as a tiling substrate in a curved wall application.

IMPORTANT NOTES





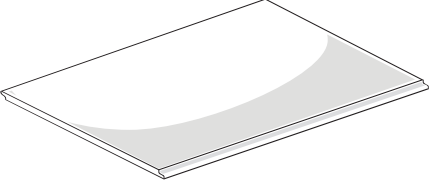

1. Failure to install, finish or maintain this product in accordance with applicable building codes, regulations, standards and James Hardie's written application instructions may lead to personal injury, affect system performance, violate local building codes, and void James Hardie's product warranty.
2. All warranties, conditions, liabilities (direct, indirect or consequential) and obligations whether arising in contract, tort or otherwise other than those specified in James Hardie's product warranty are excluded to the fullest extent allowed by law. For James Hardie's product warranty information and disclaimers about the information in this manual, see the section at the end of this manual.
3. The builder must ensure the product meets aesthetic requirements before installation. James Hardie will not be responsible for rectifying aesthetic surface variations following installation.
4. Make sure your information is up to date. When specifying or installing James Hardie® products, ensure you have the current manual. If in doubt, or you need more information, visit www.jameshardie.com.au, www.accel.com.au or Ask James Hardie™ on 13 11 03.
5. Only use water based waterproofing systems tested and warranted by the waterproofing companies such as those recommended in this application guide on page 10.

EASYLAP™ PANEL SIZES (MM)

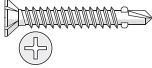
	Pre-primed sheet with a ship lap edge joint along the two long edges. Sheet weighs approximately 12kg/m ² in equilibrium.				
	PART NO.	LENGTH (mm)	WIDTH (mm)	THICKNESS (mm)	MASS (kg)
	404184	2440	1200	8.5	36
	404185	3000	1200	8.5	44
	404186	3000	900	8.5	33



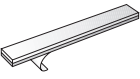
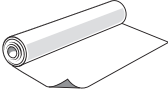

All dimensions and masses are approximate and subject to manufacturing tolerances.

ACCESSORIES / TOOLS SUPPLIED BY JAMES HARDIE

ACCESSORIES	DESCRIPTION	QUANTITY
	HardieDrive™ Screw 40mm long (only for steel frames) A class 3 finish self-tapping wing-tipped screw for fastening to 0.8mm to 1.6mm BMT steel frames. Part No. 305533	500 per box
	James Hardie™ 50mm wide Foam Back Sealing Tape. 25mtr long roll A self-adhesive foam tape to help improve water tightness with EasyLap™ panel and Scyon™ Axon™ cladding. It is applied under sheet joints to the HardieWrap™ weather barrier along the stud face. Part No. 304560	1 each
	James Hardie™ Joint Sealant. 300ml cartridge/600ml sausage. General purpose, paintable, exterior grade polyurethane joint sealant. Part No. 305534/305672	20 per box
	James Hardie™ 75x75mm Colorbond® Corner Flashing. 3,000mm long A Colorbond® corner flashing for use behind cladding at internal and external corners. Part No. 305564	5 per pack
	HardieBreak™ thermal strip (only for steel frames) A building code requirement and is installed behind James Hardie external cladding over metal framing and HardieWrap™ weather barrier. Refer to HardieBreak™ thermal strip installation guide. Unit size 43 x 12 x 2750mm. Part No. 305612	45 per pack
	HardieWrap™ weather barrier A non-perforated, highly breathable and reflective safe-glare weather barrier designed to be used behind EasyLap™ cladding to help protect the building. For alternate products, please refer to HardieWrap™ weather barrier section (p.5) Unit size 2750mm x 3000mm Part No. 305664.	1 roll
TOOLS		
	HardieBlade™ Saw Blade. 185mm diameter A 185mm diameter poly-diamond blade for fast and clean cutting of James Hardie™ fibre cement. Part No. 300660	1 Each

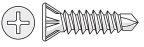
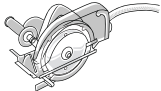
ACCESSORIES / TOOLS NOT SUPPLIED BY JAMES HARDIE

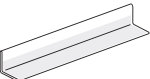
James Hardie recommends the following products for use in conjunction with the EasyLap™ panels. James Hardie does not supply these products. Please contact the component manufacturer for information on their warranties and further information on their products.

ACCESSORIES	DESCRIPTION	ACCESSORIES	DESCRIPTION
	Buldex FibreZIP® (only for steel frames) 40mm long for fixing EasyLap™ panels into steel frames of 0.55mm to 0.75mm BMT.		Dust-reducing saw Dust reducing saw with a HardieBlade® saw blade Makita 5057KB Hitachi C7YA
	Timber Screw (only for timber frames) Type 17 screw, self embedding for fixing to timber.		
	Vacuum extraction with HEPA filter Used with HEPA filter and paper bag for reduced dust exposure.		Tile support angle bracket Installed over the EasyLap™ panels and fixed back to the frame to act as a shelf to support tiles.
	Waterproofing primer and membrane Supplied by third party and applied over the EasyLap™ panels prior to tiling.		Tile Adhesive Supplied by third party and applied over the waterproofing system to adhere tiles.

2 SAFE WORKING PRACTICES

WARNING - DO NOT BREATHE DUST AND CUT ONLY IN WELL VENTILATED AREA

James Hardie products contain sand, a source of respirable crystalline silica which is considered by some international authorities to be a cause of cancer from some occupational sources. Breathing excessive amounts of respirable silica dust can also cause a disabling and potentially fatal lung disease called silicosis, and has been linked with other diseases. Some studies suggest smoking may increase these risks. During installation or handling: (1) work in outdoor areas with ample ventilation; (2) minimise dust when cutting by using either 'score and snap' knife, fibre cement shears or, where not feasible, use a HardieBlade® saw blade and dust reducing circular saw attached to a HEPA vacuum; (3) warn others in the immediate area to avoid breathing dust; (4) wear a properly-fitted, approved dust mask or respirator (e.g. P1 or P2) in accordance with applicable government regulations and manufacturer instructions to further limit respirable silica exposures. During clean-up, use HEPA vacuums or wet cleanup methods - never dry sweep. For further information, refer to our installation instructions and Material Safety Data Sheets available at www.jameshardie.com.au. FAILURE TO ADHERE TO OUR WARNINGS, MATERIAL SAFETY DATA SHEETS, AND INSTALLATION INSTRUCTIONS MAY LEAD TO SERIOUS PERSONAL INJURY OR DEATH.

JAMES HARDIE RECOMMENDED SAFE WORKING PRACTICES

CUTTING OUTDOORS

1. Position cutting station so wind will blow dust away from the user or others in working area.
2. Use one of the following methods based on the required cutting rate:
 - Best** ■ Fibreshear
 - Better** ■ Dust reducing circular saw equipped with HardieBlade™ Saw blade and HEPA vacuum extraction.
 - Good** ■ Dust reducing circular saw equipped with HardieBlade™ saw blade.

CUTTING INDOORS

- Cut only using fibreshears (manual, electric or pneumatic).
- Position cutting station in a well-ventilated area

DRILLING / OTHER MACHINING

When drilling or machining you should always wear a P1 or P2 dust mask and warn others in the immediate area.

IMPORTANT NOTES

1. For maximum protection (lowest respirable dust production), James Hardie recommends always using "Best" - level cutting methods where feasible.
2. NEVER use a power saw indoors.
3. NEVER use a circular saw blade that does not carry the HardieBlade™ logo.
4. NEVER dry sweep - Use wet suppression or HEPA vacuum.
5. NEVER use grinders.
6. ALWAYS follow tool manufacturers' safety recommendations.

P1 or P2 respirators should be used in conjunction with above cutting practices to further reduce dust exposures. Additional exposure information is available at www.jameshardie.com.au to help you determine the most appropriate cutting method for your job requirements. If concern still exists about exposure levels or you do not comply with the above practices, you should always consult a qualified industrial hygienist or contact James Hardie for further information.

STORAGE AND HANDLING

To avoid damage, all James Hardie building products should be stored with edges and corners of the product protected from chipping. James Hardie building products must be installed in a dry state and protected from weather during transport and storage. The product must be laid flat under cover on a smooth level surface clear of the ground to avoid exposure to water, moisture, etc.

3 DESIGN / FRAMING

SCOPE

General

This manual covers the use of the EasyLap™ panel as an external tiling substrate in residential buildings over a seasoned timber wall frame or a light-gauge steel frame.

Tile weight must not exceed 50kg/m².

DESIGN

General

All design and construction must comply with the appropriate requirements of the current Building Code of Australia (BCA) and other applicable regulations and standards. Refer to the nominated waterproofing and tile adhesive third party manufacturer for warrantable systems over EasyLap™ panels.

Responsibility

The specifier or other party responsible for the project must ensure that the details in this specification are appropriate for the intended application and that additional detailing is performed for specific design or any areas that fall outside the scope of this specification.

Slab and footings

The slab and footings on which the building is situated must comply with AS 2870 'Residential slabs and footings – Construction' and the requirements of the Building Code of Australia (BCA).

Ground clearances

Install James Hardie external cladding with a minimum 150mm clearance to the earth on the exterior of the building or in accordance with local building codes if greater than 150mm is required. Maintain a minimum 50mm clearance between James Hardie external cladding and roofs, decks, paths, steps and driveways.

Adjacent finished grade must slope away from the building in accordance with local building codes, typically a minimum slope of 50mm over the first metre.

Do not install external cladding such that it may remain in contact with standing water.

NOTE

Greater clearance may be required in order to comply with termite protection provisions, see below for more information.

Termite Protection

The BCA specifies the requirements for termite barriers. Where the exposed slab edge is used as part of the termite barrier system, a minimum of 75mm of the exposed slab edge must be visible to permit ready detection of termite entry.

Structural bracing

EasyLap™ panels can be installed to provide wall bracing against lateral forces due to wind. For further information, refer to the James Hardie Structural Bracing Application Guide.

Fire rated walls

EasyLap™ panels can achieve fire ratings of 60/60/60 and 90/90/90 when constructed with additional components as specified in the James Hardie Fire and Acoustically Rated Design Manual and Technical Specification.

Moisture Management

It is the responsibility of designer or specifier to identify moisture related risks associated with any particular building design. Wall construction design must effectively manage moisture, accounting for both the interior and exterior environments of the building, particularly in buildings that have a higher risk of wind driven rain penetration or that are artificially heated or cooled.

In addition, all wall openings, penetrations, junctions, connections, window sills, heads and jambs must incorporate appropriate flashing and waterproofing. Materials, components and their installation that are used to manage moisture in framed wall construction must, at a minimum, comply with the requirements of relevant standards and the BCA.

HardieWrap™ weather barrier

HardieWrap™ weather barrier must be installed under EasyLap™ panels in accordance with the AS/NZS 4200.2 'Pliable building membranes and underlays – Installation' and HardieWrap™ Technical Data Sheet.

HardieWrap™ weather barrier delivers a triplshield of protection to help against external weather penetration, internal condensation build-up and external heat penetration. Additionally, it enhances the wall thermal performance, please refer to www.jameshardie.com.au or www.accel.com.au for more information.

If using an alternate product in lieu of HardieWrap™ weather barrier, the designer must ensure that the product is fit for purpose and it has the following properties in accordance with AS/NZS 4200.1:

- Vapour barrier - low or medium
- Water barrier - high

In hot humid areas of Australia, HardieWrap™ weather barrier may not be suitable, refer to the building designer for a suitable membrane and Ask James Hardie® on 13 11 03.

Soft compressible insulation installed between the front of the wall studs and directly behind the external cladding can cause installation issues and is thus not recommended.

Flashing

All wall openings, penetrations, intersections, connections, window sills, heads and jambs must be flashed prior to cladding installation.

FRAMING

General

The EasyLap™ panels are installed vertically to both timber or metal studs.

Maximum stud spacings for EasyLap™ panels in an external tile application is 450mm. Ensure double studs are well fastened together and flush at the outside face.

For timber framing, minimum stud dimensions must be 90x45mm.

If using a stud width of 35mm, double studs must be installed and fixed together at sheet joints. Double studs are suggested to increase landing width for fasteners.

For steel framing, double 35mm wide studs must be installed at vertical EasyLap™ panel joints.

Timber

Use of timber framing must be in accordance with AS 1684 - 'Residential timber-framed construction' and the framing manufacturer's specifications.

Use only seasoned timber. Unseasoned timber must not be used because it is prone to shrinkage and can cause sheets and frames to move.

'Timber used for house construction must have the level of durability appropriate for the relevant climate and expected service life and conditions including exposure to insect attacks or to moisture, which could cause decay.' Reference AS 1684.2

Steel

Use of steel framing must be in accordance with NASH standard for Residential and Low-Rise Steel Framing Part 1: Design Criteria and the framing manufactures specifications. Framing members must have a base metal thickness (BMT) between 0.55 to 1.6mm. The steel framing must have the appropriate level of durability required to prevent corrosion.

Thermal Break

For steel frames, the Building Code of Australia sections J1.5 and 3.12.1 volumes 1 and 2 respectively, state for both residential and commercial buildings a thermal break with an R value of 0.2m²K/W must be installed behind external cladding where the cladding and internal lining make direct contact with the same steel frame. James Hardie® recommends the HardieBreak™ thermal strip. Refer to the HardieBreak™ thermal strip installation guide for more information.

Tolerances

Ensure frame is square and work from a central datum line. Frames must be straight and true to provide a flush face to receive the sheeting.

A suggested maximum tolerance of between 3mm and 4mm in any 3000mm length of frame will give best results, see Figure 1.

EasyLap™ panels will not straighten excessively warped or distorted frames and any warping may still be visible after the cladding is applied.



FIGURE 1 FRAME STRAIGHTNESS

4 PREPARATION AND FASTENERS

FRAME PREPARATION

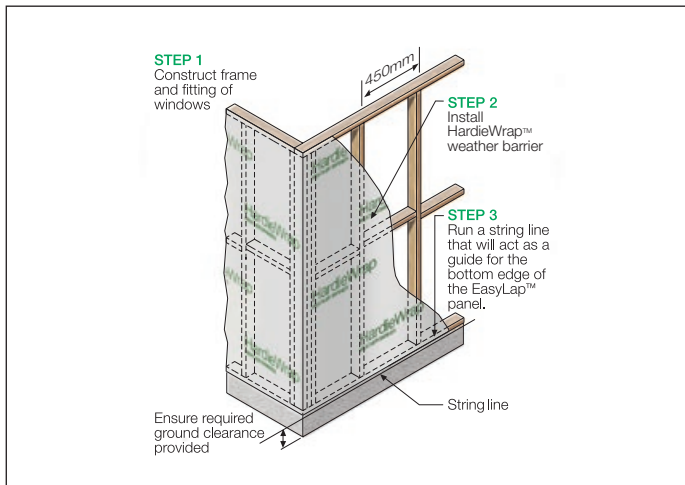

FIGURE 2 PREPARATION

NOTES

Generally, external and internal corners have additional framing requirements. Refer to the external and internal corner details for more information.

FASTENERS

General

Screws must be driven flush with surface of cladding as overdriving the screws can reduce holding capacity. Fastener spacing along the stud must be a maximum 150mm, 12mm from horizontal sheet edges, 50mm from corners and 18mm from vertical sheet edges. Refer to Figure 4 and 6.

Timber frames

For timber frames, use a min. class 3, 8-10g x 40mm timber screw with a type 17 point.

Steel frames

For 0.55mm - 0.75mm BMT steel framing, use a min. class 3, 40mm Buildex FibreZIP® screws.

For 0.8mm - 1.6mm BMT steel framing, use 40mm HardieDrive® screws or Quikdrive® 40mm. Refer to thermal break statement on page 5.

For steel frames, fasteners should be screwed as close as possible to the stud corners to avoid deflection of the stud flange.

Fastener Durability (Including coastal areas)

Fasteners must have the appropriate level of durability required for the intended project. In areas within 1km of a coastal area, areas subject to salt spray and other corrosive environments, class 4 fasteners must be used. All other areas require a minimum class 3 fastener. Fasteners must be fully compatible with all other materials that they are in contact with to ensure the durability and integrity of the assembly. Contact fastener manufacturers for more information.

SHEET INSTALLATION

NOTE

You must ensure the product is of acceptable quality prior to installation, see Important Note 3 on page 2.

EasyLap™ panels must be installed vertically with all sheet edges fully supported. Centre of sheet joints must coincide with the centre line of the framing member and all sheets are installed in one direction.

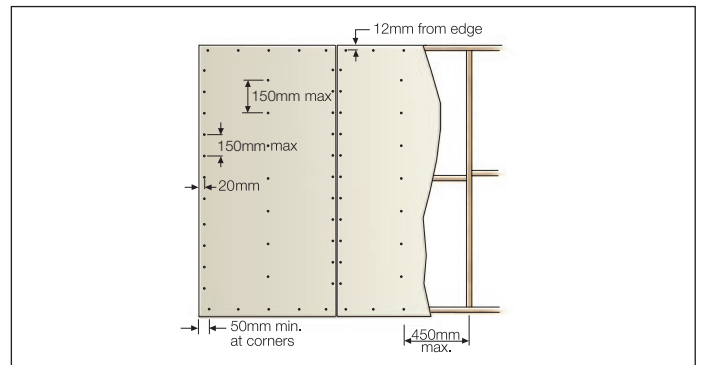

FIGURE 3 SHEET FASTENING SPACING

At every vertical sheet joint, a 50mm foam back sealing tape is to be applied in front of the HardieWrap™ weather barrier, see Figure 4.

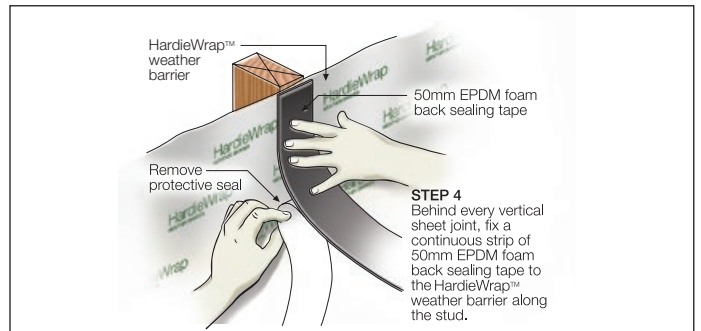

FIGURE 4 APPLY FOAM TAPE AT SHEET JOINS

To ensure the fasteners fixed at the edge of the sheet have adequate edge distance into the stud, position the underlap sheet on every stud 3mm beyond the centre of the stud.

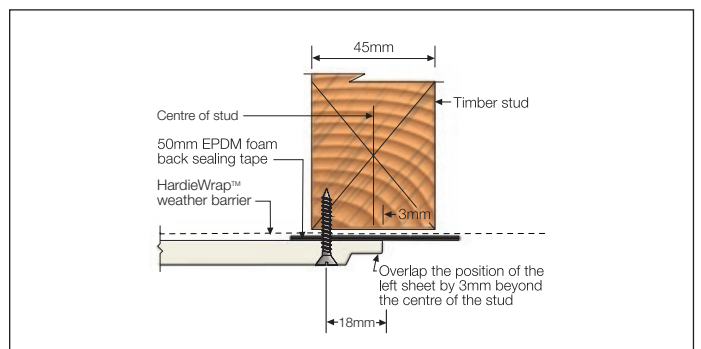

FIGURE 5 SHEET EDGE POSITION ON STUD

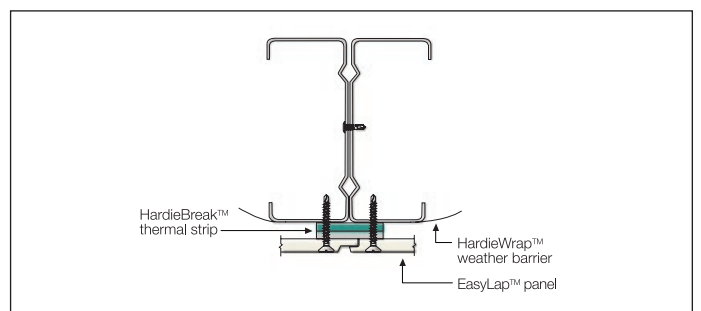

FIGURE 6 STEEL FRAME STUD

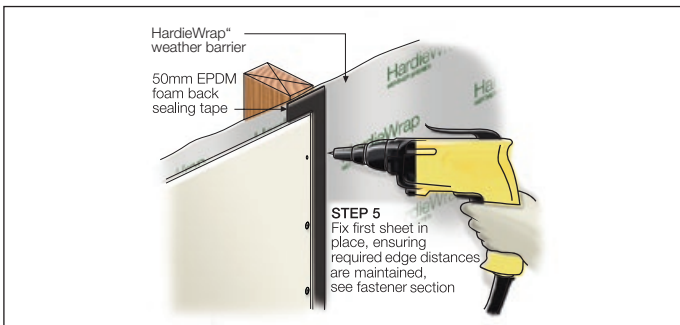

FIGURE 7 FIX FIRST SHEET

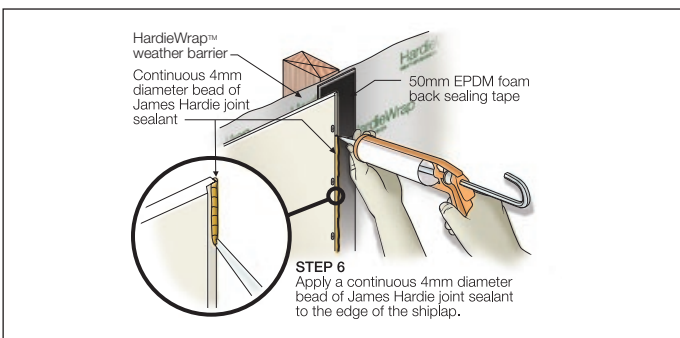

FIGURE 8 APPLY JOINT SEALANT

NOTE

1. Notch tip of sealant nozzle to act as a guide down the sheet edge.
2. Alternatively, it is acceptable to apply sealant to the overlapping sheet edge before installation.

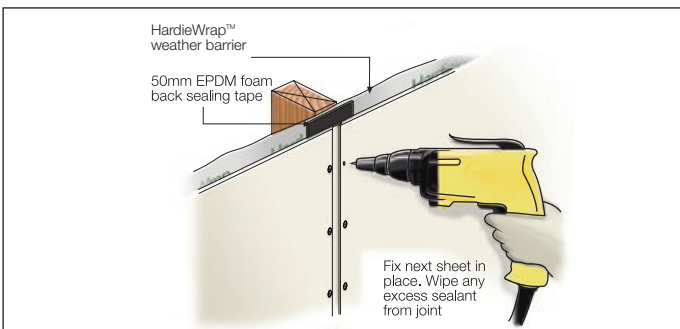

FIGURE 9 FIX NEXT SHEET

NOTE

After overlapping sheet is installed, inspect joint for gaps and fill with additional sealant.

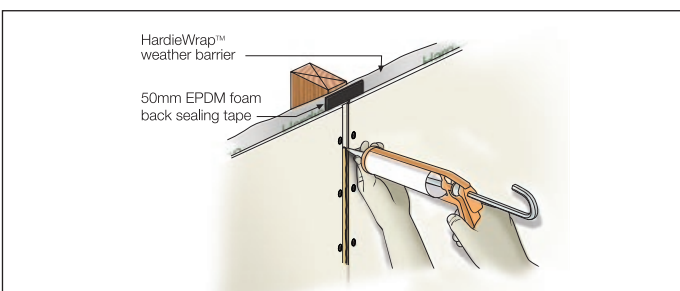

FIGURE 10 APPLY SEALANT TO JOINT GROOVE

NOTE

Fill the groove with sealant until flush with the surface of the sheet.

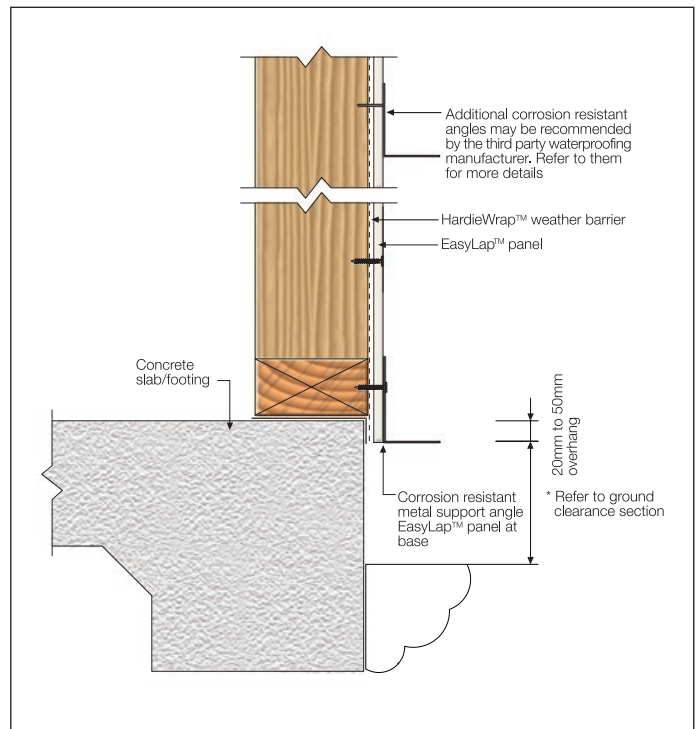

FIGURE 11 TILE SUPPORT ANGLE

NOTE

Support angles are installed at the bottom of every sheet and must be a minimum base metal thickness (BMT) of 1.2mm for tiles exceeding 32 kg/m² in weight or 18mm in thickness.

Sheet control joints

Vertical control joints in the EasyLap™ panel must be created every 6m. Sheet joints must be attached to independent framing and run through to the external tiles. Refer to figure 15 for details. Refer to chosen tile manufacturer for tile control joint detailing and spacing.

5 DETAILS

EXTERNAL CORNER DETAILS

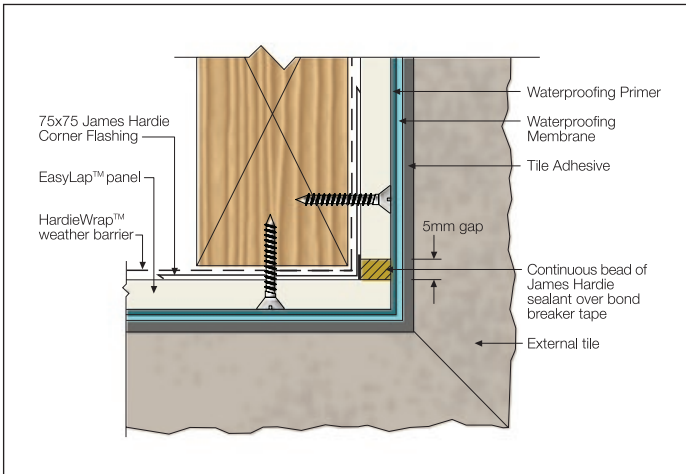

FIGURE 12 EXTERNAL CORNER

NOTE

Refer to tile manufacturer on layout of tiles.

INTERNAL CORNER DETAILS

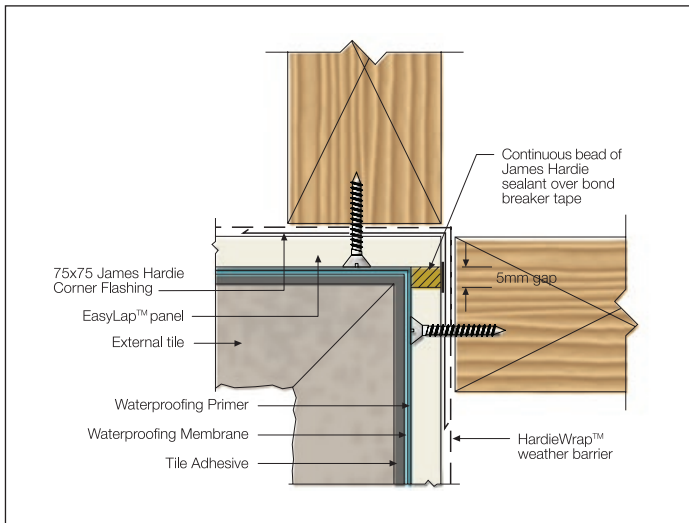

FIGURE 13 INTERNAL CORNER

JUNCTION DETAILS

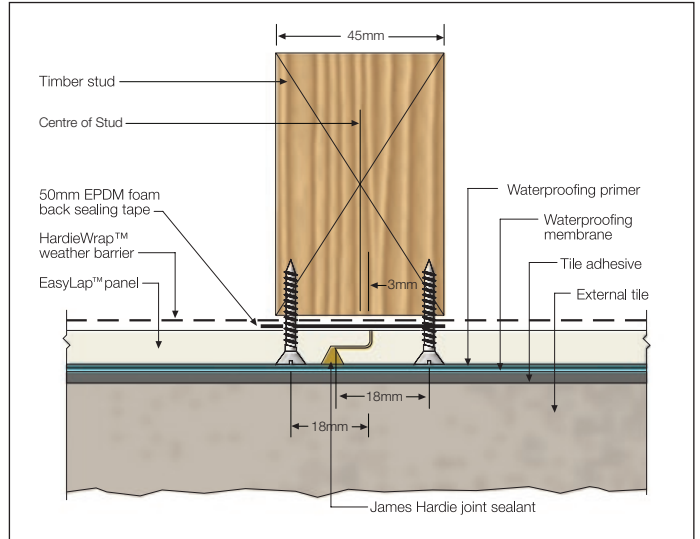

FIGURE 14 VERTICAL BUTT JOINT

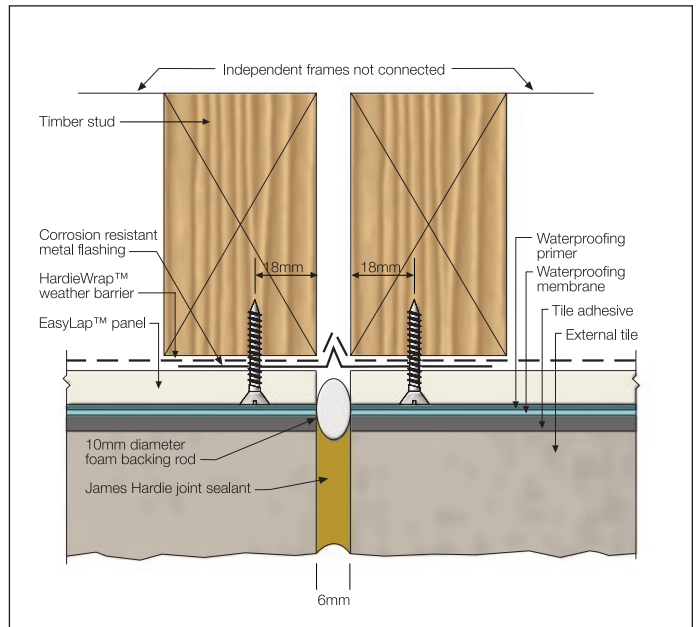

FIGURE 15 VERTICAL CONTROL JOINT

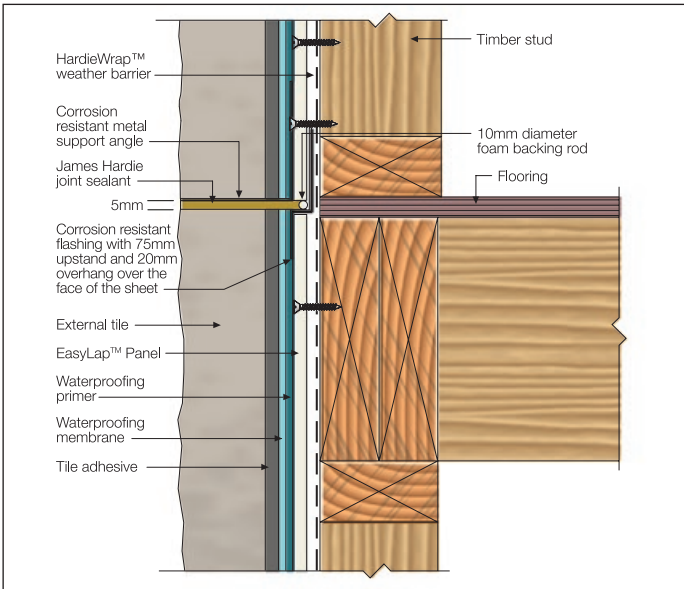

FIGURE 16 UPPER FLOOR JUNCTION

The EasyLap™ panels must not continue over a floor junction or where excessive movement or creep will occur.

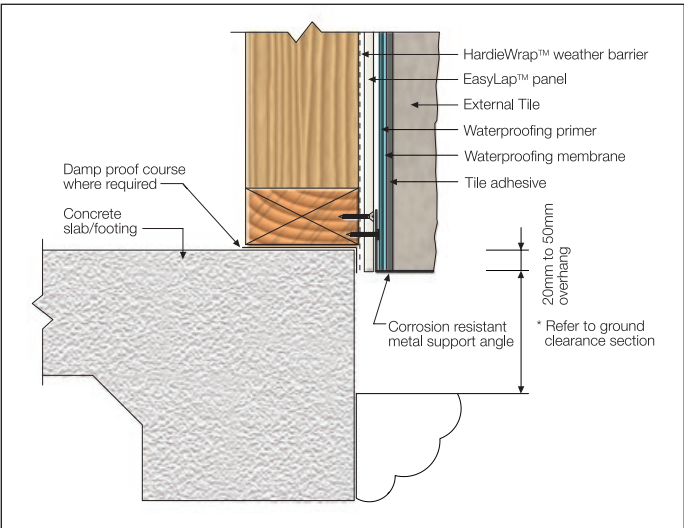

FIGURE 17 SLAB JUNCTION DETAIL

6 WATERPROOFING SYSTEM AND TILING

Waterproofing system (primer and membrane)

It is mandatory to apply a third party, warranted waterproofing system over the EasyLap™ panels in an external tiling application.

Only use warranted and tested waterproofing systems suitable for use on EasyLap™ panels and complying with AS 4654.1, such as those supplied by the companies below.

- Ardex Australia Pty. Ltd.
- Bostik Australia Pty. Ltd.
- Parex Davco Australia Pty. Ltd.

A warranted third party waterproof system and finish must be applied to the EasyLap™ panels within 3 months of installation. Keep sheets dry during this period. Refer to the third party waterproofing companies on their waterproofing system recommendations at sheet joints, junctions, and edges to maintain the wall waterproofing integrity.

All waterproofing systems must be sufficiently flexible across sheet joints to accommodate movement of all covering materials. The waterproofing system must be installed by a licensed/accredited applicator who will provide a waterproofing guarantee.

Tile adhesive

Tiles should be applied with proprietary adhesive that conforms to ISO 13007.1 for Ceramic Tiles and Adhesives, installed in accordance with AS3958.1 and to tile and adhesive manufacturer recommendations. Use a flexible tile adhesive recommended for exposed exterior applications and compatible with all other materials.

The installer is to ensure that the tile adhesive is:

- compatible with the third party waterproofing system used
- sufficiently flexible for the application
- approved by the adhesive manufacturer for use over fibre cement
- correct for the type of tile being used (e.g. marble). Additives in the tile adhesive may be required.

Mastic type tile adhesives are not recommended.

Tiles

Refer to tile manufacturer for tiles suitable for external applications and recommendations for sealing tiles. Maximum allowable tile weight is 50kg/m². Moisture sensitive tiles are not recommended. Stone tiles such as stackstone may be used.

If the tile weight exceeds 32 kg/m² and/or 18mm in thickness, additional mechanical support angles are required. It is recommended that this be assessed by a qualified structural engineer or appropriate professional. Appropriate measures must be taken to adequately support heavy and/or large format tiles. For information on installation instructions, warranty suitable waterproofing systems, tile adhesives and tiles, refer to AS 4654.2, AS 3958 and contact the relevant waterproofing, tile adhesive and tile manufacturers.

The use of ceramic tiles are not recommended if using steel framing.

Tile control joints

Refer to the waterproofing and tile manufacturer and relevant tiling codes for maximum tile control joint spacing, product suitability and compatibility including grout, tile adhesive, tile and waterproofing warranty and maintenance requirements including bond breaker tape with EasyLap™ panels.

Do not line tile grout joints with EasyLap™ sheet joints.

MAINTENANCE

The extent and nature of maintenance will depend on the geographical location and exposure of the building. As a guide, it is recommended that basic normal maintenance tasks shall include but not be limited to:

- Washing down exterior surfaces every 6-12 months*
- Periodic inspections should be made to ensure fasteners are adequately securing the sheets to framing.
- Re-applying of exterior protective finishes*
- Maintaining the exterior envelope and connections including joints, penetrations, flashings and sealants that may provide a means of moisture entry beyond the exterior cladding.
- Cleaning out gutters, blocked pipes and overflows as required.
- Pruning back vegetation that is close to or touching the building.

*Refer to your tile manufacturer for washing down and any other maintenance requirements related to tile performance e.g. the need to seal tiles.

7 PRODUCT INFORMATION

PRODUCT INFORMATION

Material

The basic composition is Portland cement, ground sand, cellulose fibre and water. James Hardie building products are manufactured to Australian/New Zealand Standard AS/NZS 2908.2 'Cellulose-cement products-Flat sheet.'

EasyLap™ panels are classified Type A, Category 3 in accordance with AS/NZS 2908.2.

Durability

Resistance to moisture/rotting

EasyLap™ panels have demonstrated resistance to permanent moisture induced deterioration (rotting) by passing the following tests in accordance with AS/NZS 2908.2:

- Water permeability (Clause 8.2.2)
- Heat rain (Clause 6.5)
- Warm water (Clause 8.2.4)
- Soak dry (Clause 8.2.5)

Resistance to fire

The EasyLap™ panels are suitable where non-combustible materials are required in accordance with C1.12 of the Building Code of Australia.

James Hardie building products have been tested by CSIRO in accordance with AS/NZS 3837 and are classified as conforming to Group 1 material (highest and best result possible), with an average specific extinction area far lower than the permissible 250m²/kg, as referenced in Specification C1.10a of the BCA.

Resistance to termite attack

Based on testing completed by CSIRO Division of Forest Products and Ensis Australia, James Hardie building products have demonstrated resistance to termite attack.

Alpine regions

The information and application outlined in this manual is not suitable for alpine environments.

8 WARRANTY

James Hardie does not warrant the performance of third party components which include but is not limited to waterproofing primers and membranes, tile adhesive, tiles and water ingress. Refer to the third party companies for their warranted systems, warranty, installation and specifications to AS 3958 - Ceramic Tiles and AS 4654 - Waterproofing membranes.

EasyLap™ panel

10 YEAR WARRANTY

James Hardie Australia Pty Limited ("James Hardie") warrants to the first purchaser of EasyLap™ panel (**Product**) from James Hardie and the last purchaser of the Product prior to installation that, subject to compliance with the Conditions of Warranty below:

- for a period of 10 years from the date of purchase, the Product will be free from defects due to defective factory workmanship or materials; and
- for a period of 10 years from the date of purchase, the Product will be resistant to damage from cracking, moisture, rotting, fire and termites to the extent set out in James Hardie's relevant published literature current at the time of installation; and
- for a period of 12 months from the date of purchase that the accessories supplied by James Hardie will be free from defects due to defective factory workmanship or materials.

For the purposes of this warranty, a "defect" in respect of the Product means a non-compliance with AS/NZS 2908.2:2000 Cellulose-cement products - Flat sheet.

CONDITIONS OF WARRANTY

This warranty is strictly subject to the following conditions:

- (a) James Hardie will not be liable for breach of this warranty unless the claimant provides proof of purchase of the Product and makes a written claim to James Hardie at the address set out below, either within 30 days after the defect would have become reasonably apparent or, if the defect was reasonably apparent prior to installation, then the claim must be made prior to installation.
- (b) the Product is subject to natural variation in finish as part of the manufacturing process. The builder/installer must ensure the Product meets aesthetic requirements before installation. Subject to the terms of this warranty, after installation of the Product, James Hardie is not liable for claims arising from aesthetic surface variations if such variations were, or would upon reasonable inspection have been, apparent prior to installation;
- (c) this warranty cannot be relied upon by any other person and is not transferable;
- (d) the Product must be installed and maintained strictly in accordance with the relevant James Hardie literature current at the time of installation and must be installed in conjunction with the components or products specified in the literature. To obtain copies of such literature go to or contact Ask James Hardie™ on 13 11 03. Further, all other products, including coating and jointing systems, applied to or used in conjunction with the Product must be applied or installed and maintained strictly in accordance with the relevant manufacturer's instructions and good trade practice;
- (e) the project must be designed and constructed in strict compliance with all relevant provisions of the current Building Code of Australia, regulations and standards;
- (f) if the claimant chooses to rely upon this warranty then the claimant's sole remedy under this warranty for breach of this warranty is (at James Hardie's option) that James Hardie will either supply replacement Product, rectify the affected Product or pay for the cost of the replacement or rectification of the affected Product;

- (g) In the circumstances where the Australian Consumer Law does not apply in respect of the purchase of the Product, James Hardie will not be liable for any losses or damages (whether direct or indirect including property damage or personal injury, consequential loss, economic loss or loss of profits, arising in contract or negligence or howsoever arising. Without limiting the foregoing, James Hardie will not be liable for any claims, damages or defects arising from or in any way attributable to poor workmanship, poor design or detailing, settlement or structural movement and/or movement of materials to which the Product is attached, incorrect design of the structure, acts of God including but not limited to earthquakes, cyclones, floods or other severe weather conditions or unusual climatic conditions, efflorescence or performance of paint/coatings applied to the Product, normal wear and tear, growth of mould, mildew, fungi, bacteria, or any organism on any Product surface or Product (whether on the exposed or unexposed surfaces);
- (h) In the circumstances where the Australian Consumer Law does not apply in respect of the purchase of the Product, all warranties, conditions, liabilities and obligations other than those specified in this warranty are excluded to the fullest extent allowed by law;
- (i) If meeting a claim under this warranty involves re-coating of Product, there may be slight colour differences between the original and replacement Product due to the effects of weathering and variations in materials over time and James Hardie is not liable for any such colour differences;
- (j) In the circumstances where the Australian Consumer Law does not apply in respect of the purchase of the Product and therefore to this warranty, all expenses incurred as a result of claiming under this warranty are to be borne by the claimant.
- (k) In the circumstances where the Australian Consumer Law does apply in respect of the purchase of the Product and therefore to this warranty, if James Hardie accepts or it is determined by James Hardie that the claimant has a valid claim under this warranty, James Hardie will bear the claimant's reasonable costs of claiming under this warranty. The claimant is responsible for all other costs of claiming under this warranty. All claims for such costs are to be notified to James Hardie at the address outlined below within 21 days from when the claimant first makes a claim under this warranty.

DISCLAIMER

The recommendations in James Hardie's literature are based on good building practice but are not an exhaustive statement of all relevant information and are subject to conditions (d), (e), (g) and (h) above. Further, as the successful performance of the relevant system depends on numerous factors outside the control of James Hardie (e.g. quality of workmanship and design), James Hardie shall not be liable for the recommendations in that literature and the performance of the relevant system, including its suitability for any purpose or ability to satisfy the relevant provisions of the Building Code of Australia, regulations and standards.

IMPORTANT NOTE

If you acquire goods manufactured by James Hardie as a consumer according to the Australian Consumer Law, our goods come with guarantees that cannot be excluded under the Australian Consumer Law. You are entitled to a replacement or refund for a major failure and compensation for any other reasonably foreseeable loss or damage. You are also entitled to have the goods repaired or replaced if the goods fail to be of acceptable quality and the failure does not amount to a major failure.

Any rights a consumer may have under this warranty are in addition to other rights and remedies of a consumer under a law in relation to the goods to which this warranty relates. Nothing in this document shall exclude or modify any legal rights a customer may have under the Australian Consumer Law or otherwise which cannot be excluded or modified at law.

Contact details if you wish to make a claim under this warranty: For more information or to make a claim under this warranty please Ask James Hardie™ on 13 11 03, visit www.jameshardie.com.au or www.accel.com.au, email James Hardie via our website or write to James Hardie at:

James Hardie Australia Pty Ltd
10 Colquhoun Street Rosehill NSW 2142
PO Box 70 Parramatta NSW 2124



Ask James Hardie™
Call 13 11 03
www.jameshardie.com.au

© Copyright 2014 James Hardie Australia Pty Ltd. ABN 12 084 635 558.
™ and ® denotes a trademark or registered mark owned by James Hardie Technology Limited