



PREMIUM PELMET

EXTERIOR BLIND

ASSEMBLY GUIDE

Installing your new Coolaroo Exterior Blind is simple, following our step-by-step instructions.

PARTS LIST

Description	Qty
a. Premium Pelmet	1
b. Crank Handle	1
c. Caps with Rings	2
d. Bungee Tie Downs	2
e. Bottom Rail	1
f. Bungee Receiver	2
g. Screws	10
h. Quick Mount Brackets	3
i. Wall Plugs	10
j. Shade	1
k. Template	1

You will also need:

- Power drill
- Phillips-head screwdriver
- Level
- Tape Measure
- Pencil

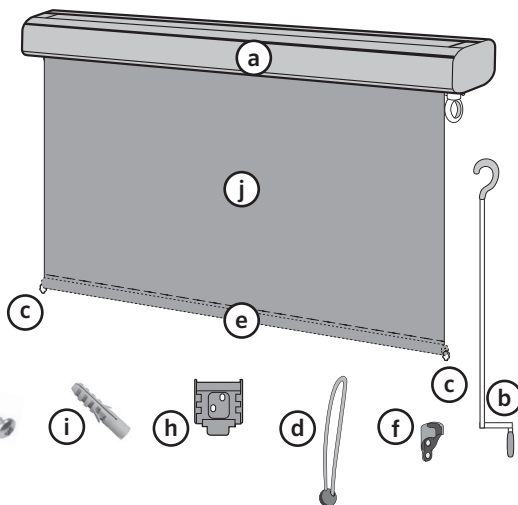

coolaroo.com





SETTING MOUNTING POINTS USING THE TEMPLATE (k)

The unique pelmet design allows for face mounting (Fig. 1) or top mounting (Fig. 2) of the blind to suit your installation environment.

Use temporary fixing (ie. tape) to attach the Template (k) to your mounting surface - ensuring it is level. The three Quick Mount Brackets (h) can be positioned anywhere inside each of three grey areas on the template, allowing for location of timber studs, if required. There must be one Quick Mount Bracket in each of the three grey areas (Fig. 3), ensuring they are spaced far enough apart for best support and weight distribution.

Use your pencil to mark your preferred bracket positions on the template, ensuring you have allowed **50mm clearance** for attachment of the pelmet.

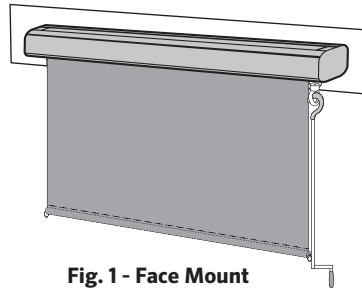

Fig. 1 - Face Mount

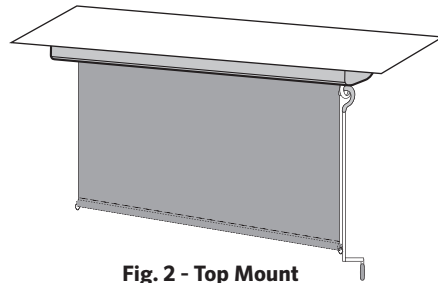

Fig. 2 - Top Mount

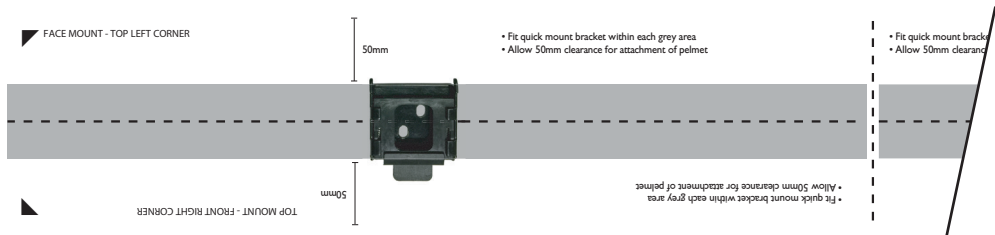

Fig. 3

INSTALL QUICK MOUNT BRACKETS (h)

When fitting the brackets make sure they are positioned with the tabs pointing forward (for top mount) or downward (for face mount) (Fig. 4 and Fig. 5), to allow easy fitting and removal of the shade.

If fixing into masonry, drill a 5mm hole and insert Wall Plugs (i). **DO NOT SCREW INTO PLASTER UNLESS YOU ARE USING SCREWS LONG ENOUGH TO FULLY PENETRATE THE TIMBER SUB-FRAME.**

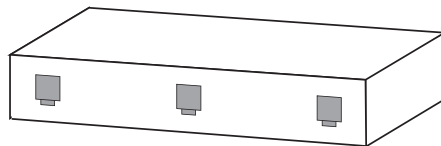

Fig. 4 - Face Mount

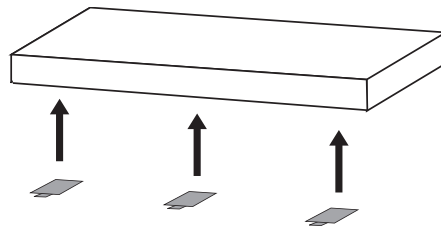

Fig. 5 - Top Mount





Ensure the Quick Mount Brackets are orientated correctly (Fig. 6) then secure into place with Screws (g) using a Philips-Head Screwdriver.

The brackets must be positioned and installed level to ensure the blind functions properly.

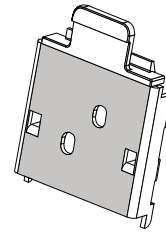

Fig. 6

INSTALL PELMET (a)

Install the Pelmet (a) by locating the tabs on each bracket into the channel on the pelmet and then snapping the housing securely into place.

NOTE : If the brackets have been installed upside down or backwards the pelmet will not fit.

INSTALL BUNGEE TIE DOWNS (d) (Optional)

Bungee Tie Downs can be used to help keep your shade steady in mild to moderate wind conditions.

Thread the bungee cord through the Bottom Rail End Cap Rings (c) and back through itself making a Lark's Head Knot (Fig. 7)

Use a drill and the remaining fixings to install the Bungee Receiver (f) (Fig. 8) approximately 130mm below the bottom of where the shade will stop, to allow for adequate tension of the Bungee Tie Down (d).

Stretch the Bungee Tie Downs until they hook over the Bungee Receiver to keep the shade taught in the down position.

Note: Ensure the Bungee Tie Downs are released before raising the blind.

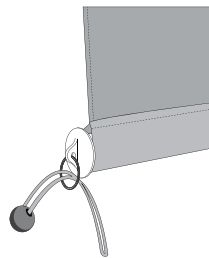

Fig. 7

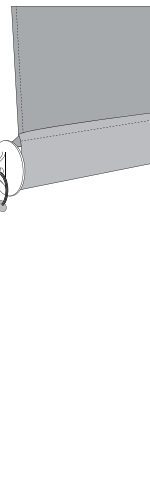

Fig. 8

RAISING AND LOWERING THE SHADE

Locate the hook on the Crank Handle (b) through the adjustment eyelet located on the right hand side of the pelmet (Fig. 9). Turn the Crank Handle to lower or raise the Shade (j) to the desired position (Fig. 10).

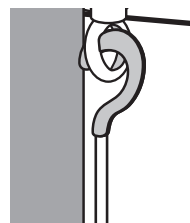

Fig. 9

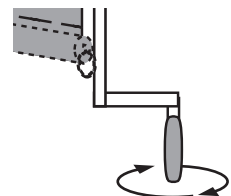

Fig. 10





Handy tip when raising your blind

To prevent the blind from running askew when winding up, have someone hold the bottom rail to keep it taught while turning the crank handle.

MAINTENANCE:

Your Exterior Blind has been made of the finest materials and, when properly cared for, will provide years of shade, privacy and protection from the elements. To clean your shade, simply rinse with water, scrub with mild soap or any nonabrasive cleaner, rinse and allow to dry.

Do not store shade wet. In moist areas roll shade down frequently to air dry.

CAUTION: Use of solvents or abrasive cleaners may damage the fabric and will void your warranty. Do not use bleach or chlorine.



Fully retract the Shade when not in use, or before strong storms to prevent damage.

GALE
P A C I F I C

Gale Pacific Limited 145 Woodlands Drive, Braeside, Victoria,
3195 Australia

Gale Pacific (NZ) Limited Suite A 45C Mt Wellington Highway,
Mt Wellington, Auckland 1060 New Zealand

For help with product assembly or for any other questions you may have, contact our Customer Service Department.

Australia Toll Free: 1800 331 521

New Zealand Toll Free: 0800 555 171

United States Ph: +1 407 772 7900

Middle East Ph: +971 4 881 7114

China Ph: +86 574 5626 8888

©Coolaroo is a registered trademark of Gale Pacific Limited.

Made in China.



coolaroo.com

