



18V LITHIUM ION

# CORDLESS JIGSAW

## INSTRUCTION MANUAL

### SPECIFICATIONS

Voltage:	18V
No Load Speed:	0 - 2,400spm
Stroke Depth:	25.4mm
Bevel:	+/- 45°
Blade Fitment:	T-Shank
Cutting Capacities:	Timber 80mm Mild Steel 10mm Plastic 12mm
Weight:	1.85kg

ozito.com.au

**5 YEAR**  
REPLACEMENT WARRANTY

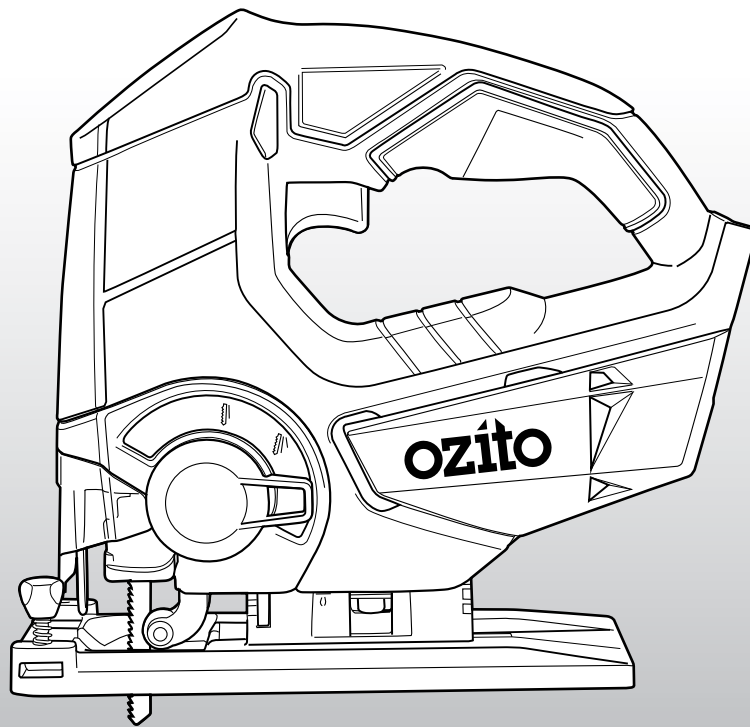

### WHAT'S IN THE BOX

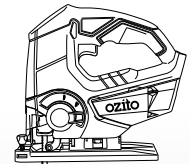

Jigsaw

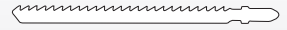

Blade

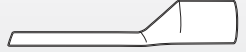

Dust Extraction Adaptor

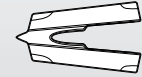

Splinter Guard



Parallel Guide

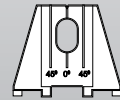

Line Guide

Battery & Charger  
sold separately

**PXJSS-600**

## WARRANTY

IN ORDER TO MAKE A CLAIM UNDER THIS WARRANTY YOU MUST RETURN THE PRODUCT TO YOUR NEAREST BUNNINGS WAREHOUSE WITH YOUR BUNNINGS REGISTER RECEIPT. PRIOR TO RETURNING YOUR PRODUCT FOR WARRANTY PLEASE TELEPHONE OUR CUSTOMER SERVICE HELPLINE:

Australia 1800 069 486  
New Zealand 0508 069 486

TO ENSURE A SPEEDY RESPONSE PLEASE HAVE THE MODEL NUMBER AND DATE OF PURCHASE AVAILABLE. A CUSTOMER SERVICE REPRESENTATIVE WILL TAKE YOUR CALL AND ANSWER ANY QUESTIONS YOU MAY HAVE RELATING TO THE WARRANTY POLICY OR PROCEDURE.

### WARNING

The following actions will result in the warranty being void.

- If the tool has been operated on a supply voltage other than that specified on the tool.
- If the tool shows signs of damage or defects caused by or resulting from abuse, accidents or alterations.
- Failure to perform maintenance as set out within the instruction manual.
- If the tool is disassembled or tampered with in any way.

The benefits provided under this warranty are in addition to other rights and remedies which are available to you at law.

Our goods come with guarantees that cannot be excluded at law. You are entitled to a replacement or refund for a major failure and for compensation for any other reasonably foreseeable loss or damage. You are also entitled to have the goods repaired or replaced if the goods fail to be of acceptable quality and the failure does not amount to a major failure.

Generally you will be responsible for all costs associated with a claim under this warranty, however, where you have suffered any additional direct loss as a result of a defective product you may be able to claim such expenses by contacting our customer service helpline above.

### 5 YEAR REPLACEMENT WARRANTY

Your Product is guaranteed for a period of 60 months from the original date of purchase and is intended for DIY (Do It Yourself) use only. If a product is defective it will be replaced in accordance with the terms of this warranty. Lithium Ion batteries and chargers are covered by a 36 month warranty. Warranty excludes consumable parts, for example: cutting blades.

# KNOW YOUR PRODUCT

## CORDLESS JIGSAW

- |                       |                             |
|-----------------------|-----------------------------|
| 1 Guide Locking Screw | 7 Battery Seating           |
| 2 LED Light           | 8 Guide Roller              |
| 3 Blade Lock          | 9 Adjustable Shoe           |
| 4 Lock Off Switch     | 10 Pendulum Action Selector |
| 5 On/Off Trigger      | 11 Shoe Locking Lever       |
| 6 Sure Grip Handle    |                             |

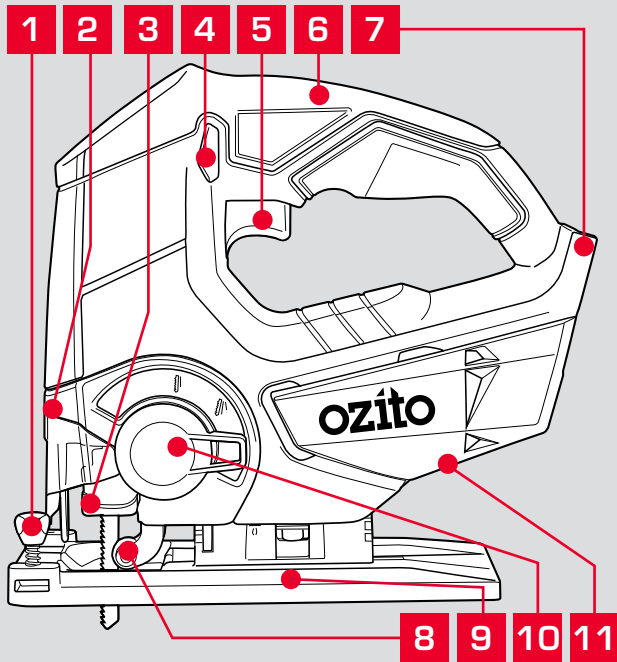

## ACCESSORIES

- |                            |                   |
|----------------------------|-------------------|
| 12 Dust Extraction Adaptor | 14 Parallel Guide |
| 13 Splinter Guard          | 15 Line Guide     |

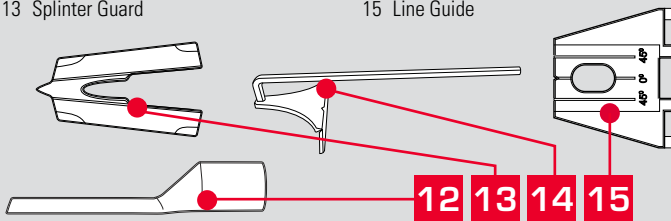

## BATTERY & CHARGER (sold separately)

This tool is compatible with all battery and chargers from the Ozito Power X Change Range.

### ONLINE MANUAL

Scan this QR Code with your mobile device to take you to the online manual.



**5 YEAR**  
REPLACEMENT WARRANTY

# SETUP & PREPARATION

## 1. ASSEMBLY



**WARNING!** ENSURE THE TOOL IS SWITCHED OFF AND THE BATTERY IS REMOVED BEFORE PERFORMING ANY OF THE FOLLOWING TASKS.

### Inserting the Blade

- 1 Hold the blade lock down.

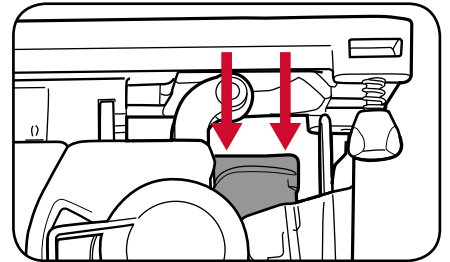

- 2 Slide the blade into the lock with the teeth facing forward making sure the blade is in the middle of the guide roller groove. Ensure the shoulder of the blade sits right at the bottom of the blade holder.

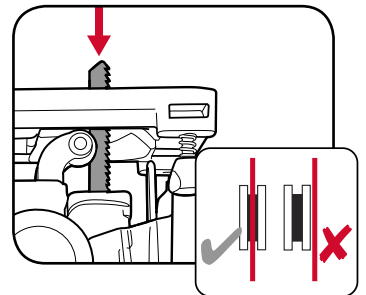

- 3 Release the blade lock and pull on the blade to ensure it is secured.

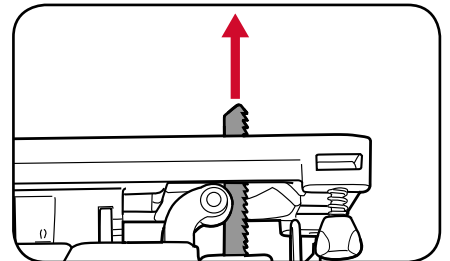

### Removing the Blade

- 1 Flip the saw upside down and hold the blade lock down.

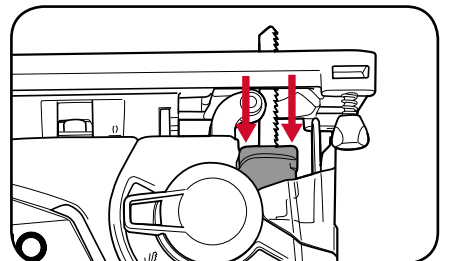

- 2 Raise the blade to remove.

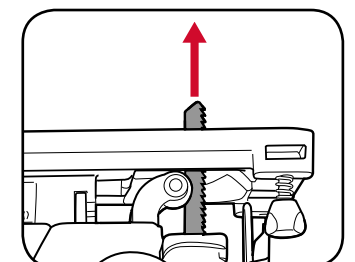

**5 YEAR**  
REPLACEMENT WARRANTY

## 2. BATTERY & CHARGING (sold separately)



**CAUTION:** THE CHARGER FOR THIS PRODUCT SHOULD BE PROTECTED BY A RESIDUAL CURRENT DEVICE (RATED AT 30MA OR LESS).

The purchased battery will be shipped in a low charge condition, and requires charging prior to use. Allow several cycles of charging and discharging (through use of the tool) for the battery to reach its optimum performance / runtime.

### Charging your lithium ion battery - Fast Charger

1 Connect the charger into a mains power outlet.

2 The charger LED will flash green showing power is being supplied to the charger.

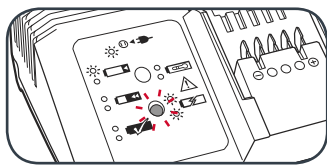

3 With the charger sitting on a flat surface, align the raised ribs on the battery with the recess in the charger and slide onto the charger ensuring a firm connection.

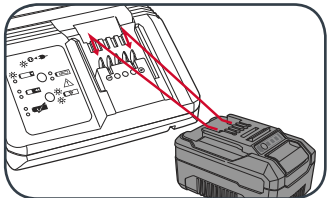

4 The charger LED will illuminate red signifying that the battery is charging.

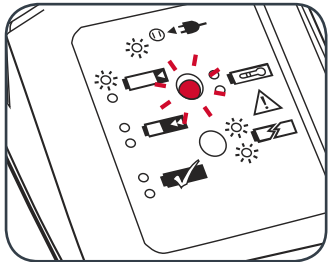

5 The charger LED will illuminate green once the battery is fully charged.

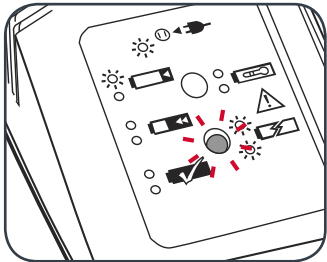

Charger LED Indicator	
LED Indicator	Situation
GREEN (Flashing)	Stand By (no battery pack is inserted)
RED (Flashing)	Battery is charging (low charge)
RED (Illuminated)	Battery is charging (mid charge)
GREEN (Illuminated)	Battery is fully charged
BOTH (Illuminated)	Battery pack is too hot or too cold (charging will begin automatically when battery reaches correct charging temperature).
BOTH (Flashing)	Defective battery. Never charge a defective battery pack! Remove battery pack from charger.

### Charging your lithium ion battery - Eco Charger

1 Connect the charger into a mains power outlet.

2 The charger LED will flash green showing power is being supplied to the charger.

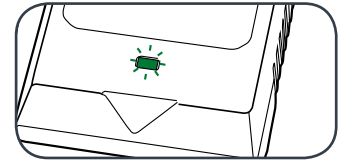

3 With the battery sitting on a flat surface, align the raised ribs on the battery with the recess in the charger and slide onto the battery ensuring a firm connection.

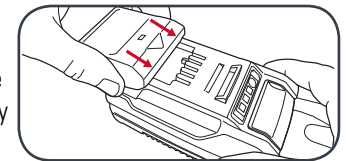

4 The charger LED will illuminate red signifying that the battery is charging.

5 When removing the charger from the battery, first press the battery release tab, then slide the charger from its position.

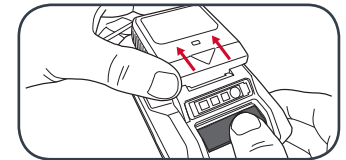

Charger LED Indicator	
LED Indicator	Situation
GREEN (Flashing)	Stand By (no battery pack is inserted)
RED (Illuminated)	Battery is charging (low charge)
GREEN (Illuminated)	Battery is fully charged
RED (Flashing)	Battery or Charger fault
RED & GREEN (Flashing)	Battery pack is too hot or too cold (remove battery from charger and store at room temperature 20°C. Insert battery again when at correct charging temperature). If this happens again, the battery is defective and needs to be replaced.

### Battery Charge Indicator

The purchased battery is equipped with a battery charge indicator to show the state of the battery charge.

Press the charge indicator button and look to see which LED lights.

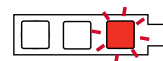
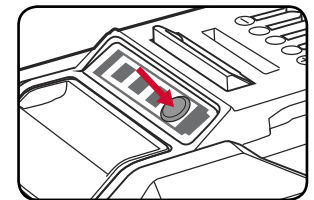

Battery requires immediate charging

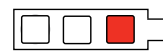

Low state of charge, requires charging soon.

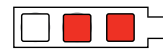

Mid state of charge

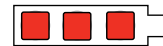

Full state of charge.

**Note:** The battery needs to be removed from the tool to check the state of charge.

### 3. FITTING THE BATTERY & GUIDE

#### Inserting & Removing the Battery (not included)

- 1 Align the ribs of the battery with the recess at the back of the handle.

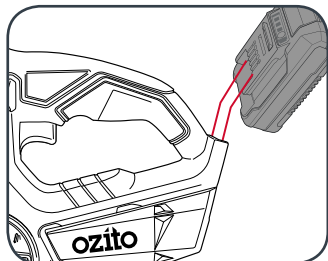

- 2 Slide the battery into the seating until it clicks into place.

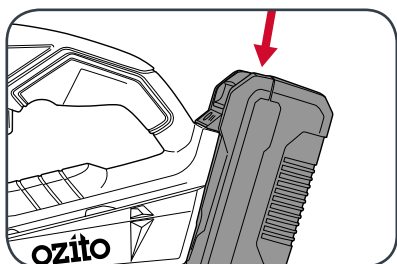

- 3 To remove, press and hold the battery release tab and then slide out.

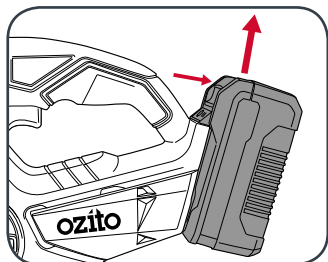

#### Attaching the Parallel Guide

The parallel guide assists in cutting in a line parallel to an edge.

- 1 Unscrew the guide locking screws at the front of the jigsaw.

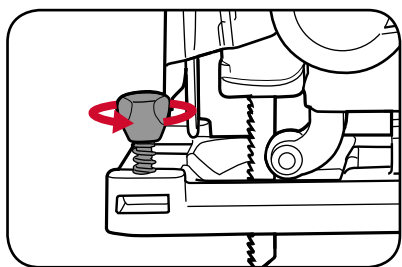

- 2 Slide the parallel guide into the slots under the locking screws.

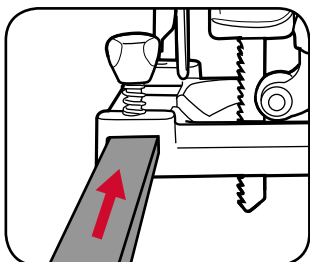

- 3 Tighten the guide locking screws to secure position.

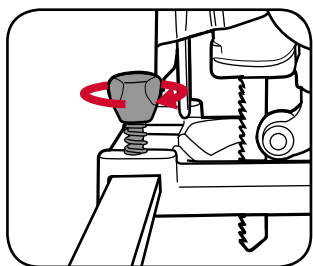

### 4. ATTACHING THE ACCESSORIES

#### Using the Splinter Guard

The splinter guard ensures that the workpiece does not splinter and crack while cutting.

- 1 Slide the front of the splinter guide into the recess on the base of the jigsaw.
- 2 Squeeze the sides of the guard to allow the back to be pushed into place.

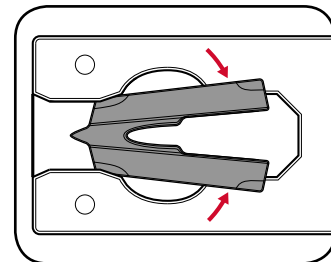
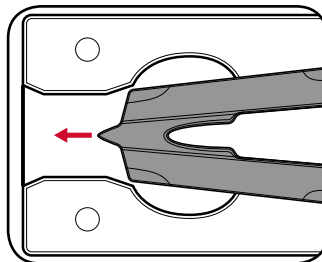

- 3 To Remove, squeeze the sides of the guard and then pull the splinter guard away from the base.

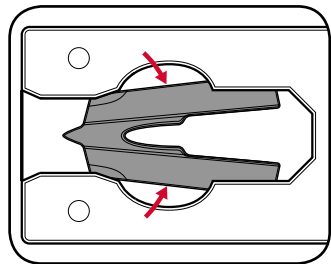

**WARNING!** THE SPLINTER GUARD CAN ONLY BE USED WHEN CUTTING AT A 90° ANGLE TO THE WORKPIECE.

#### Using the Line Guide

The line guide helps maintain a straight line while cutting at a 90° or 45° angle.

- 1 place the 2 hooks of the line guide over the rail at the front of the jigsaw.
- 2 Push the line guide down until it clicks into place to allow the line guide to be flush with the base of the jigsaw.

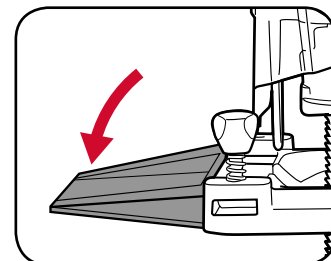
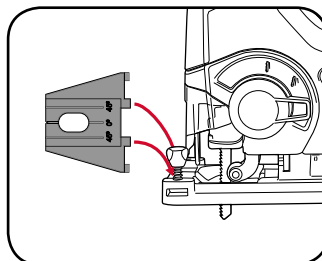

# OPERATION

## 5. SHOE ANGLE & DUST EXTRACTOR

### Adjusting the Shoe Angle

The angle of the shoe can be adjusted to allow for bevel cuts between 0 and 45°.

- 1 Push the shoe locking lever to the right to unlock the adjustable shoe.

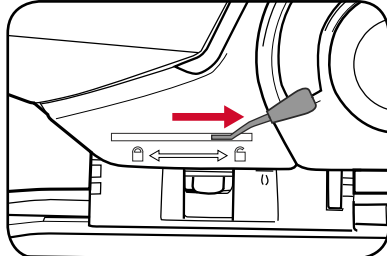

- 2 Slide the shoe forwards and tilt the shoe to the desired angle using the measurements.

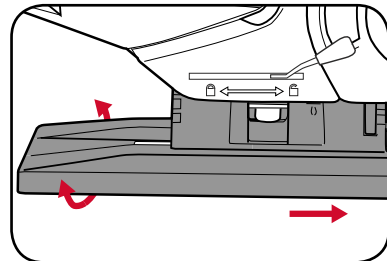

- 3 Once the angle is correct slide the shoe back for the pins to make contact and secure in place by pulling the shoe locking lever left.

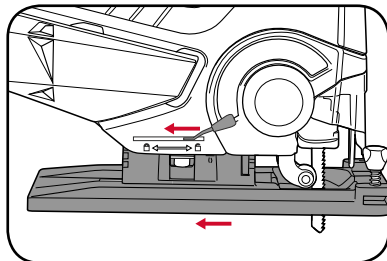

### Dust Extraction Adaptor

A dust extractor can be fitted to the jigsaw dust extraction adaptor to remove dust and chips while cutting. The adaptor can also be removed if it gets in the way.

- 1 Fit the dust extraction adaptor to the jigsaw by pushing it into its slot from the back.

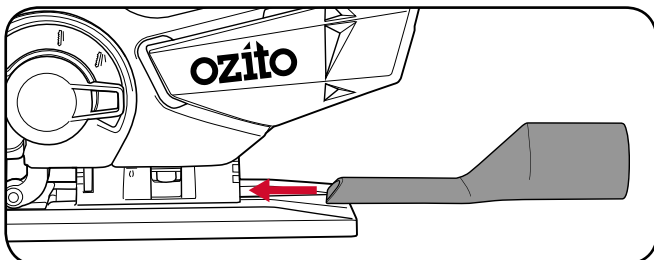

- 2 To remove simply slide the dust extraction adaptor from the back of the jigsaw.

## 6. CONTROLS

### Switching On and Off

- 1 Hold the lock-off switch down and then squeeze the on/off trigger to start the jigsaw.

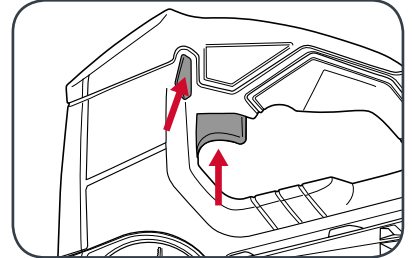

- 2 To stop operation, release the on/off trigger.

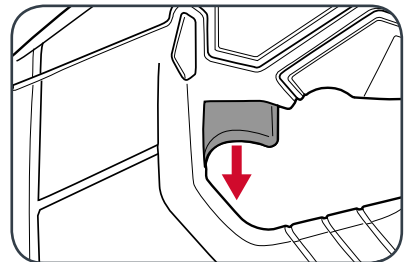

### Adjusting the Cutting Action

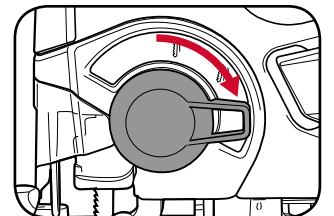

The jigsaw has a pendulum action feature which enables the blade to cut faster and more efficiently in thick and softer materials. See below for a guide on choosing the correct setting.

- 1 To use the pendulum action, rotate the pendulum action selector clockwise to a higher setting.

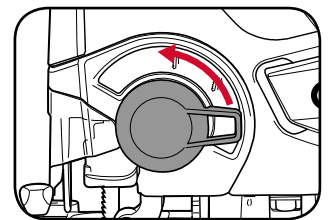

- 2 To use standard cutting action, rotate the pendulum action selector anti-clockwise to a lower setting.



1 - exact	No pendulum action for fine clean cuts on thin or hard materials
2 - 	Small pendulum action for faster cutting on hard materials
3 - 	Medium pendulum action for faster cutting on softer materials
4 - 	Large pendulum action for fast cutting along the grain on soft materials.



# OPERATION

## 7. CUTTING

- 1 Ensure the correct blade is inserted into the blade lock and is secure.

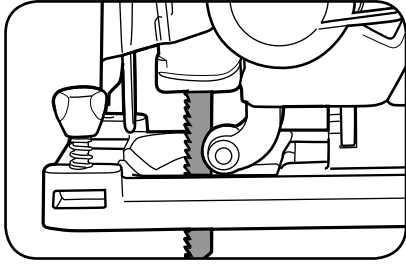

- 2 Mark your cutting line with a pencil or attach the parallel guide.

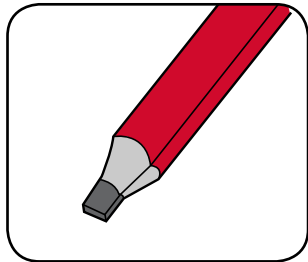

- 3 Place the base onto the workpiece with the blade away from the edge.

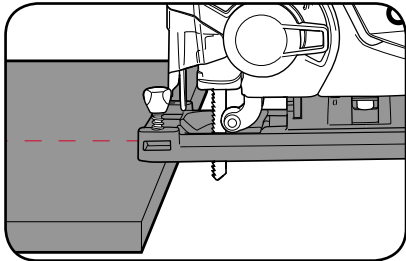

- 4 Start the jigsaw by holding the lock-off switch and depressing the on/off trigger.

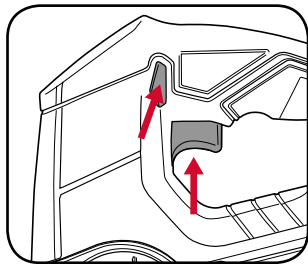

- 5 Move jigsaw forward with light pressure. Allow the blade to stop before lifting the jigsaw away.

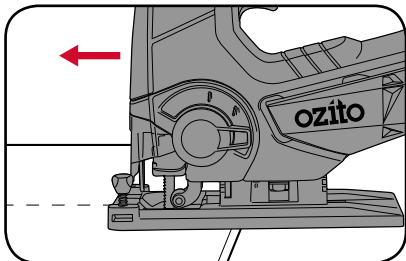

**Note:** If the jigsaw switches off during use, the tool is overloaded. Please reduce cutting pressure and/or increase pendulum action to reduce load on the tool.

## 8. POCKET CUTTING

A pocket cut is when you need to cut a hole in the middle of a workpiece

- 1 Drill a hole in the workpiece using a 12mm bit.

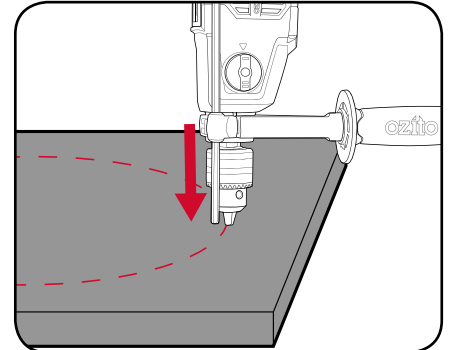

- 2 Pass the blade through the hole and begin the cut.

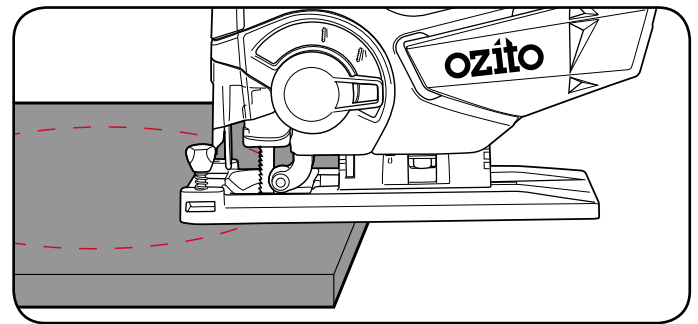

## MAINTENANCE



**WARNING!** ALWAYS ENSURE THE TOOL HAS COMPLETELY STOPPED AND THE BATTERY IS REMOVED PRIOR TO ANY MAINTENANCE.

- Keep ventilation slots of the jigsaw clean at all times to ensure efficient operation.
- After each use, blow air through the tool housing to ensure it is free from all dust, dirt, etc. Build up of dust, dirt particles may cause the tool to overheat and shorten the life of the tool.
- If the housing of the jigsaw requires cleaning, do not use solvents but a moist soft cloth or soft brush only.
- Never let any liquid get inside the tool, never immerse any part of the tool into liquid.
- No lubrication is necessary as the tool has sealed bearings.
- When not in use, the jigsaw should be stored in a dry, frost free location not within the reach of children.

Note: Ozito Industries will not be responsible for any damage or injuries caused by the repair of the jigsaw by an unauthorised person or by mishandling of the jigsaw.

Battery protection system

The tool is equipped with the battery protection system, which helps to ensure a long service life.

The output power automatically cuts off during operation when the tool and/or battery are placed under the following situations:

- When the tool is overloaded:  
If this occurs, release the trigger switch and remove causes of overload, then pull the switch trigger again to restart.
- When the remaining battery capacity becomes low:  
Recharge the battery pack.

**Note:** The battery protection system does not in any way damage the tool.

**Note:** The indicated capacity may be lower than the actual level during use or immediately after using the tool.

## TROUBLESHOOTING

LED lights do not illuminate on charger

Check the charging adaptor is securely plugged into the wall outlet.

Check the battery is firmly connected to the charging cradle.

Check that the charging jack is securely connected to the charging cradle.

The battery has a short run time

Ensure the battery is properly charged. It will take 4-5 charging cycles before the battery reaches optimum charge and run time. On the initial charge, the battery requires 5 hours of charging. Subsequent charging only requires 3-5 hours.

Sparking visible through the housing air vents

A small amount of sparking may be visible through the housing vents. This is normal and does not indicate a problem.

Cutting Metal

Your jigsaw can be used for cutting light gauge ferrous sheet and non-ferrous metals such as copper, brass, aluminium, etc. It is advisable when cutting sheet metal to clamp a backing sheet of soft wood or plywood to the work as this will enable you to obtain a clean cut without vibration and the possibility of tearing the metal. Both metal and wood backing are sawn together. Do not force the cutting blade into the metal as this will reduce the life of the blade and possibly damage the motor. Cutting thin metal will take longer than cutting even a relatively thick piece of wood, so do not be tempted to speed up the operation by forcing the saw. Spread a thin film of oil along the proposed cutting line before commencing to saw metal. Always select the right blade for the job.

Jigsaw frequently cuts out during use

If the jigsaw switches off during use, the tool is overloaded. Please reduce cutting pressure and/or increase pendulum action to reduce load on the tool.

## SPARE PARTS

Spare parts can be ordered from the Special Orders Desk at your local Bunnings Warehouse.

For further information, or any parts not listed here, visit [www.ozito.com.au](http://www.ozito.com.au) or contact Ozito Customer

Service:

Australia 1800 069 486

New Zealand 0508 069 486

E-mail: [enquires@ozito.com.au](mailto:enquires@ozito.com.au)

## CARING FOR THE ENVIRONMENT



Power tools that are no longer usable should not be disposed of with household waste but in an environmentally friendly way. Please recycle where facilities exist. Check with your local council authority for recycling advice.



Recycling packaging reduces the need for landfill and raw materials. Reuse of recycled material decreases pollution in the environment. Please recycle packaging where facilities exist. Check with your local council authority for recycling advice.



## BATTERY AND CHARGER SAFETY WARNINGS

THIS MANUAL CONTAINS IMPORTANT SAFETY AND OPERATING INSTRUCTIONS FOR YOUR BATTERY CHARGER.

- Before using the charger read all instructions and cautionary markings on the charger, battery pack and the product using the battery pack.
- This charger is not intended for any uses other than charging rechargeable batteries. Any other use may result in risk of fire, electric shock or electrocution.
- Do not place any object on top of the charger or place the charger on a soft surface that may result in excessive internal heat. Place the charger in a position away from any heat source.
- To reduce risk of damage to the electric plug and cord, pull by the plug rather than the cord when disconnecting the charger.
- Make sure the cord is located so that it will not be stepped on, tripped over, or otherwise subjected to damage or stress.
- An extension cord should not be used unless absolutely necessary. Use of an improper extension cord could result in the risk of fire, electric shock or electrocution.
- Do not operate the charger if it has received a sharp blow, been dropped or otherwise damaged in any way. Have it checked by an electrician or power tool repairer.
- Do not disassemble charger. Take it to an electrician or power tool repairer when service or repair is required. Incorrect reassembly may result in a risk of electric shock, electrocution or fire.
- To reduce risk of electric shock, unplug the charger from the outlet before attempting any cleaning. Removing the battery pack will not reduce this risk.
- Never attempt to connect 2 chargers together.
- DO NOT store or use the tool and battery pack in locations where the temperature may reach or exceed 40°C (such as inside sheds or metal buildings in summer).
- The charger is designed to operate on standard household electrical power (240 volts). Do not attempt to use it on any other voltage!
- The battery pack is not fully charged out of the carton. First read the safety instructions and then follow the charging notes and procedures.
- The longest life and best performance can be obtained if the battery pack is charged when the air temperature is between 18 - 24°C. Do not charge the battery pack in an air temperature below 10°C or above 40°C. This is important and will prevent damage to the battery pack.
- Do not incinerate the battery pack even if it is seriously damaged or is completely worn out. The battery can explode in a fire.
- Never attempt to open the battery pack for any reason. If the plastic housing of the battery pack breaks or cracks, immediately discontinue use and do not recharge.
- During charging, the battery must be placed in a well ventilated area.

## DESCRIPTION OF SYMBOLS

<b>V</b>	Volts	<b>Hz</b>	Hertz
<b>ac/~</b>	Alternating current	<b>W</b>	Watts
<b>dc/—</b>	Direct current	—	Diameter
<b>mA</b>	Milliamperes	<b>Ah</b>	Amp hour
	Do not expose to rain.	<b>No</b>	No load speed
<b>spm</b>	Strokes per minute		
	Regulatory Compliance Mark (RCM)		Transformer Energy Rating (MEPS)
	Warning		Read instruction manual
	Double insulated		Indoor use only
	Thermal cut-out protection		Polarity
	Lithium Ion battery		Do not use or store battery in temperatures exceeding 50°C
	Recycle battery		Do not put in the rubbish
	Do not incinerate		Do not get battery wet

## ELECTRICAL SAFETY

 **WARNING!** When using mains-powered tools, basic safety precautions, including the following, should always be followed to reduce risk of fire, electric shock, personal injury and material damage. Read the whole manual carefully and make sure you know how to switch the tool off in an emergency, before operating the tool.

Save these instructions and other documents supplied with this tool for future reference.

The charger has been designed for 230V and 240V only. Always check that the power supply corresponds to the voltage on the rating plate.

Note: The supply of 230V and 240V on Ozito tools are interchangeable for Australia and New Zealand.



This tool's charger is double insulated, therefore no earth wire is required.

If the supply cord is damaged, it must be replaced by an electrician or a power tool repairer in order to avoid a hazard.

Note: Double insulation does not take the place of normal safety precautions when operating this tool. The insulation system is for added protection against injury resulting from a possible electrical insulation failure within the tool.

Using an Extension Lead

Always use an approved extension lead suitable for the power input of this tool. Before use, inspect the extension lead for signs of damage, wear and ageing. Replace the extension lead if damaged or defective.

When using an extension lead on a reel, always unwind the lead completely. Use of an extension lead not suitable for the power input of the tool or which is damaged or defective may result in a risk of fire and electric shock.

The power supply for this product's charger should be protected by a residual current device (rated at 30mA or less). A residual current device reduces the risk of electric shock.

## GENERAL POWER TOOL SAFETY WARNINGS

 **WARNING!** Read all safety warnings and all instructions. Failure to follow the warnings and instructions may result in electric shock, fire and/or serious injury.

Save all warnings and instructions for future reference. The term "power tool" in the warnings refers to your mains-operated (corded) power tool or battery-operated (cordless) power tool.

### 1. Work area safety

- Keep work area clean and well lit. Cluttered or dark areas invite accidents.
- Do not operate power tools in explosive atmospheres, such as in the presence of flammable liquids, gases or dust. Power tools create sparks which may ignite the dust or fumes.
- Keep children and bystanders away while operating a power tool. Distractions can cause you to lose control.

### 2. Electrical safety

- Power tool plugs must match the outlet. Never modify the plug in any way. Do not use any adapter plugs with earthed (grounded) power tools. Unmodified plugs and matching outlets will reduce risk of electric shock.
- Avoid body contact with earthed or grounded surfaces, such as pipes, radiators, ranges and refrigerators. There is an increased risk of electric shock if your body is earthed or grounded.
- Do not expose power tools to rain or wet conditions. Water entering a power tool will increase the risk of electric shock.
- Do not abuse the cord. Never use the cord for carrying, pulling or unplugging the power tool. Keep cord away from heat, oil, sharp edges or moving parts. Damaged or entangled cords increase the risk of electric shock.
- When operating a power tool outdoors, use an extension cord suitable for outdoor use. Use of a cord suitable for outdoor use reduces the risk of electric shock.
- If operating a power tool in a damp location is unavoidable, use a residual current device (RCD) protected supply. Use of an RCD reduces the risk of electric shock.

### 3. Personal safety

- Stay alert, watch what you are doing and use common sense when operating a power tool. Do not use a power tool while you are tired or under the influence of drugs, alcohol or medication. A moment of inattention while operating power tools may result in serious personal injury.
- Use personal protective equipment. Always wear eye protection. Protective equipment such as dust mask, non-skid safety shoes, hard hat, or hearing protection used for appropriate conditions will reduce personal injuries.
- Prevent unintentional starting. Ensure the switch is in the off-position before connecting to power source and/or battery pack, picking up or carrying the tool. Carrying power tools with your finger on the switch or energising power tools that have the switch on invites accidents.
- Remove any adjusting key or wrench before turning the power tool on. A wrench or a key left attached to a rotating part of the power tool may result in personal injury.
- Do not overreach. Keep proper footing and balance at all times. This enables better control of the power tool in unexpected situations.

- Dress properly. Do not wear loose clothing or jewellery. Keep your hair, clothing and gloves away from moving parts. Loose clothes, jewellery or long hair can be caught in moving parts.
- If devices are provided for the connection of dust extraction and collection facilities, ensure these are connected and properly used. Use of dust collection can reduce dust-related hazards.

### 4. Power tool use and care

- Do not force the power tool. Use the correct power tool for your application. The correct power tool will do the job better and safer at the rate for which it was designed.
- Do not use the power tool if the switch does not turn it on and off. Any power tool that cannot be controlled with the switch is dangerous and must be repaired.
- Disconnect the plug from the power source and/or the battery pack from the power tool before making any adjustments, changing accessories, or storing power tools. Such preventive safety measures reduce the risk of starting the power tool accidentally.
- Store idle power tools out of the reach of children and do not allow persons unfamiliar with the power tool or these instructions to operate the power tool. Power tools are dangerous in the hands of untrained users.
- Maintain power tools. Check for misalignment or binding of moving parts, breakage of parts and any other condition that may affect the power tool's operation. If damaged, have the power tool repaired before use. Many accidents are caused by poorly maintained power tools.
- Keep cutting tools sharp and clean. Properly maintained cutting tools with sharp cutting edges are less likely to bind and are easier to control.
- Use the power tool, accessories and tool bits etc. in accordance with these instructions, taking into account the working conditions and the work to be performed. Use of the power tool for operations different from those intended could result in a hazardous situation.

### 5. Battery tool use and care

- Recharge only with the charger specified by the manufacturer. A charger that is suitable for one type of battery pack may create a risk of fire when used with another battery pack.
- Use power tools only with specifically designated battery packs. Use of any other battery packs may create a risk of injury and fire.
- When battery pack is not in use, keep it away from other metal objects, like paper clips, coins, keys, nails, screws or other small metal objects, that can make a connection from one terminal to another. Shorting the battery terminals together may cause burns or a fire.
- Under abusive conditions, liquid may be ejected from the battery; avoid contact. If contact accidentally occurs, flush with water. If liquid contacts eyes, additionally seek medical help. Liquid ejected from the battery may cause irritation or burns.

### 6. Service

- Have your power tool serviced by a qualified repair person using only identical replacement parts. This will ensure that the safety of the power tool is maintained.

## JIGSAW SAFETY WARNINGS

 **WARNING!** Hold power tool by insulated gripping surfaces when performing an operation where the cutting accessory may contact hidden wiring or its own cord. Cutting accessory contacting a "live" wire may make exposed metal parts of the power tool "live" and could give the operator an electric shock.

- Remove all nails in the work piece before the jigsaw. Cutting nails may damage your tool.
- Do not cut hollow pipe with the jigsaw
- Do not cut material thicker or of a wider diameter than the specified limits.
- Always allow enough clearance underneath the work piece to ensure the blade does not touch the floor or work bench, etc.
- Hold the tool at a comfortable distance from your body. Do not over reach to access the work piece.
- Do not touch moving parts with your fingers or hand. 8. Do not cut through walls or cavities without first checking for hidden electrical wires.

- Ensure that you have tightened the blade prior to starting the machine. 10. When you have finished the cut, wait until the saw blade has stopped moving prior to removing it from the work piece.
- Do not touch the saw blade immediately after use. Allow time for the blade to cool, as it may burn you due to the heat generated during sawing.
- Always check accessories to ensure that they are suitable for the operating speeds of this tool.
- Incorrect accessories can break apart at high speed and cause serious damage or injury.

This appliance is not intended for use by young or infirm persons unless supervised by a responsible person to ensure that they can use the appliance safely. Young children should be supervised to ensure that they do not play with the appliance.