

HELPFUL TIPS & INFORMATION WHEN MEASURING UP & INSTALLING YOUR WARDROBE DOORS

4 SIMPLE STEPS TO CREATING A NEW LOOK WARDROBE

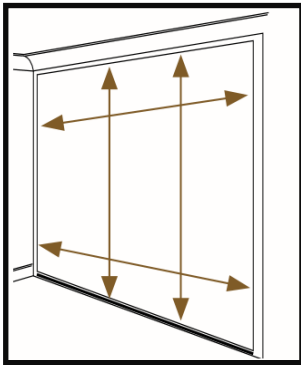

STEP 1

Check and Measure the existing daylight opening size. Heights and Widths.

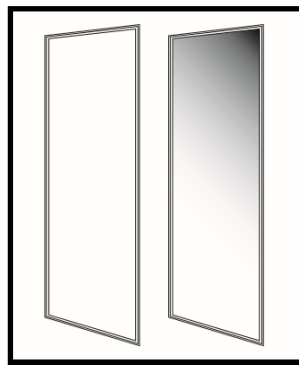

STEP 2

Choose the style of door you require. Mirror, White Melamine or a combination of both.

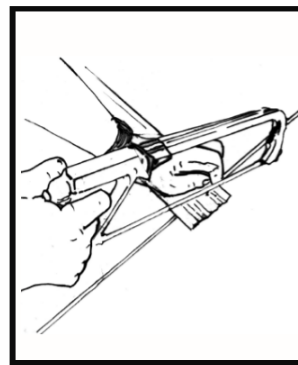

STEP 3

Top and bottom tracks can be cut to suit the size of opening.



STEP 4

Install doors into top and bottom track. Final adjustment can be made with the adjustment screw on the back of the door.

IMPORTANT NOTE: A 2010mm door will suite a daylight opening size between 2040mm to 2060mm

OPENING SIZES TO SUIT 2 DOOR DESIGN USING A 76MM DOUBLE TRACK

2 doors on a 76mm wide track will allow you to have half the wardrobe open at one time.

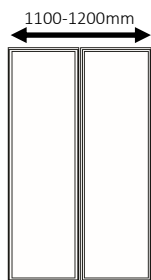

2 x 2010mm h x 610mm w

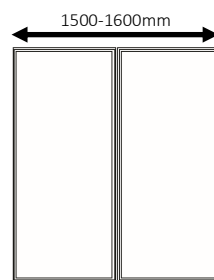

2 x 2010mm h x 810mm w

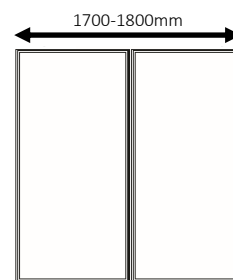

2 x 2010mm h x 910mm w

OPENING SIZES TO SUIT 3 DOOR DESIGN USING A 122MM TRIPLE TRACK

3 doors on a triple track will allow you to have two-thirds of the wardrobe open at any one time.

Perfect for wardrobes that have drawer units placed near the centre of the opening.

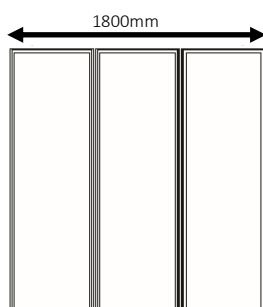

3 x 2010mm h x 610mm w

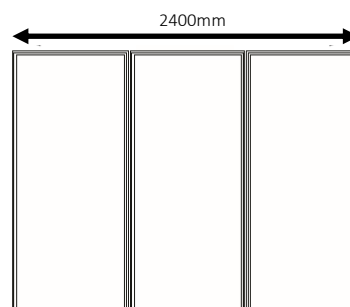

3 x 2010mm h x 810mm w

IMPORTANT NOTE: A 2010mm door will suit a maximum daylight opening height of 2080mm, however to do this you will first need to place a 19mm thick floor batten down.