

MR501

Martini

Oliveri®

LEFT HAND BOWL SINK

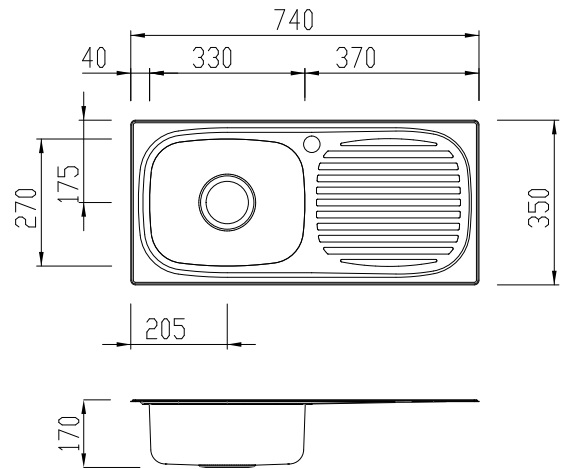

INCLUDED ACCESSORIES

AC14



AC02

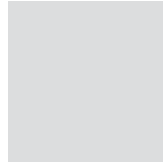
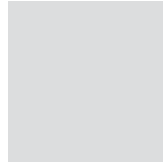
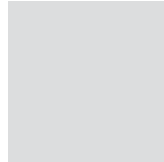
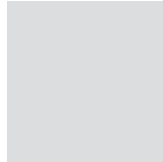

RECOMMENDED TAPWARE

PA113/2



MV617/6



OPTIONAL ACCESSORIES

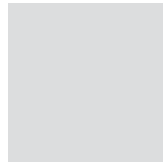
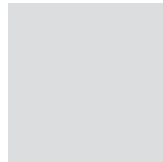
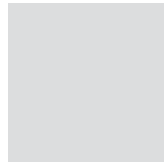
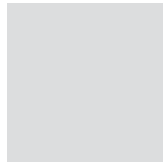
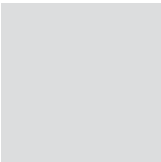
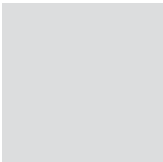

SPECIFICATIONS

Description

3/4 bowl inset sink with drainer

Sink Size

740W x 350H

3/4 Bowl

330W x 270H x 155D / 12L

Construction

2 piece, bowls & drainer seam welded

Material

304 grade, 18/10 polished stainless steel (0.8mm thick)

Installation

Inset recommended.

Fixings

Adjustable clips and sealing foam supplied

Cut Out Template

720 x 330 x 15mm radius

Min Cabinet Size

500mm

Tap holes

Available 0 or 1 tap hole (specify when ordering)

Waste fittings

1 x 90mm basket waste included

Overflow

Not available

Carton Size

757 x 367 x 182mm

Weight

4.0kg

Warranty

Lifetime manufacturer's warranty (refer to oliverisinks.com)

For more information call **1300 13 7465** or visit **www.oliverisinks.com**

