

ozito

COMPOUND MITRE SAW

210mm (8¼")

INSTRUCTION MANUAL

SPECIFICATIONS

Motor:	1600W (S6 40%), 1400W (S1)
No Load Speed:	5,000/min
Blade:	Ø210mm x Ø16 x 48T
Mitre Angle:	0-45° left & right
Bevel Angle:	0-45° left
Max. Cutting Capacity:	
Mitre 0° x Bevel 90°:	55x120mm
Mitre 0° x Bevel 45°:	32x120mm
Mitre 45° x Bevel 90°:	55x80mm
Mitre 45° x Bevel 45°:	32x80mm
Weight:	7.1kg

ozito.com.au

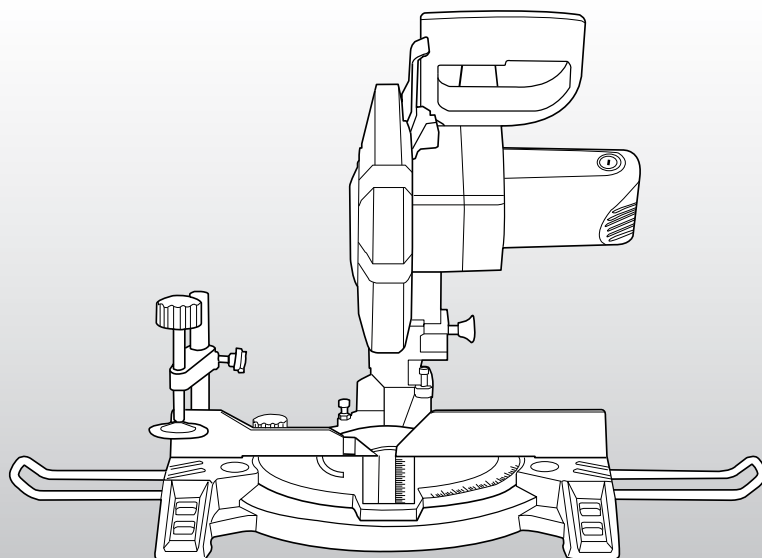

WHAT'S IN THE BOX

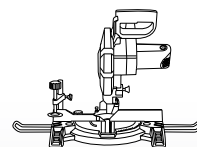

Compound Mitre Saw



Dust Collection Bag



Material Clamp

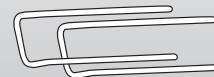

Material Support Bars



Hex Keys, 5 & 6mm

3 YEAR REPLACEMENT WARRANTY

CMS-1621

WARRANTY

IN ORDER TO MAKE A CLAIM UNDER THIS WARRANTY YOU MUST RETURN THE PRODUCT TO YOUR NEAREST BUNNINGS WAREHOUSE WITH YOUR BUNNINGS REGISTER RECEIPT. PRIOR TO RETURNING YOUR PRODUCT FOR WARRANTY PLEASE TELEPHONE OUR CUSTOMER SERVICE HELPLINE:

Australia 1800 069 486

New Zealand 0508 069 486

TO ENSURE A SPEEDY RESPONSE PLEASE HAVE THE MODEL NUMBER AND DATE OF PURCHASE AVAILABLE. A CUSTOMER SERVICE REPRESENTATIVE WILL TAKE YOUR CALL AND ANSWER ANY QUESTIONS YOU MAY HAVE RELATING TO THE WARRANTY POLICY OR PROCEDURE.

The benefits provided under this warranty are in addition to other rights and remedies which are available to you at law.

Our goods come with guarantees that cannot be excluded at law. You are entitled to a replacement or refund for a major failure and for compensation for any other reasonably foreseeable loss or damage. You are also entitled to have the goods repaired or replaced if the goods fail to be of acceptable quality and the failure does not amount to a major failure.

Generally you will be responsible for all costs associated with a claim under this warranty, however, where you have suffered any additional direct loss as a result of a defective product you may be able to claim such expenses by contacting our customer service helpline above.

3 YEAR REPLACEMENT WARRANTY

Your product is guaranteed for a period of **36 months from the original date of purchase** and is intended for DIY (Do It Yourself) use only. If a product is defective it will be replaced in accordance with the terms of this warranty. Warranty excludes consumable parts, for example:

WARNING

The following actions will result in the warranty being void.

- If the tool has been operated on a supply voltage other than that specified on the tool.
- If the tool shows signs of damage or defects caused by or resulting from abuse, accidents or alterations.
- Failure to perform maintenance as set out within the instruction manual.
- If the tool is disassembled or tampered with in any way.
- Professional, industrial or high frequency use.

KNOW YOUR PRODUCT

MITRE SAW

- | | |
|-----------------------------|-------------------------|
| 1. Material Support Bar | 7. Rotating Mitre Table |
| 2. Material Clamp | 8. Head Locking Pin |
| 3. Rear Fence | 9. Release Lever |
| 4. Retractable Safety Guard | 10. On/Off Switch |
| 5. Mitre Lock Knob | 11. Carbon Brush Cap |
| 6. Movable Stop | 12. Operating Handle |

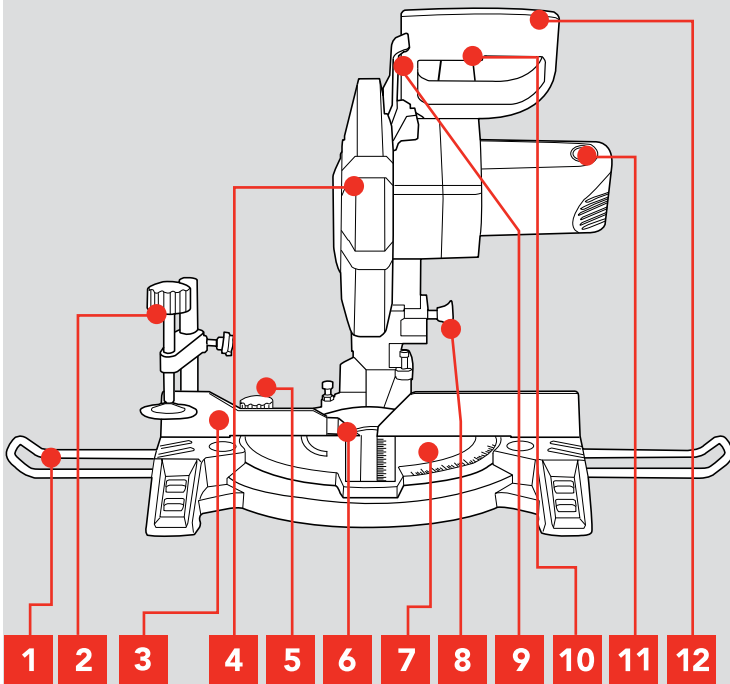

13. Hex Keys, 5 & 6mm

14. Dust Bag

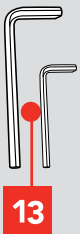

13



14

ONLINE MANUAL

Scan this QR Code with your mobile device to take you to the online manual.



SETUP & PREPARATION

1. ASSEMBLY



WARNING! ENSURE THE SAW IS SWITCHED OFF AND DISCONNECTED FROM THE POWER SUPPLY BEFORE PERFORMING ANY OF THE FOLLOWING ASSEMBLY.

1. Remove foam packaging materials and using the carry handle, carefully lift the mitre saw from its box and place it on a level work surface.
2. Release cutting head from its transport position. While holding the head of the saw down release the lock down knob.

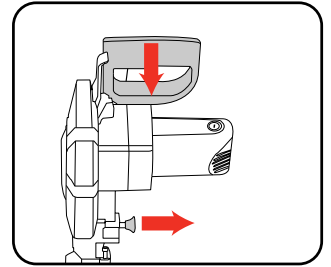

Fitting the Dust Bag

1. Squeeze the clamp at the end of the dust bag.

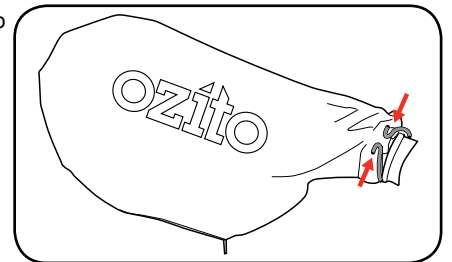

2. Slide the end of the dust bag over the dust extraction port and release the clamp.

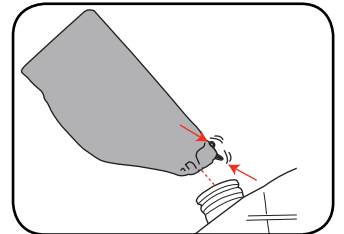

Material Support Bar

1. Insert the material support bars into the 2 holes on either side of the base.

2. Secure in place with the 5mm hex key.

Note: Ensure they are fully inserted.

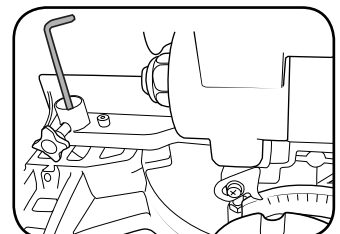
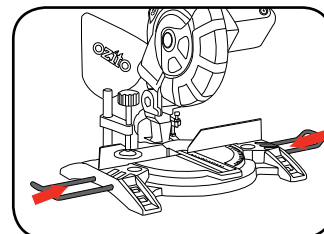

Material Clamp

1. Can be mounted to the fence, either the left or right hand side.

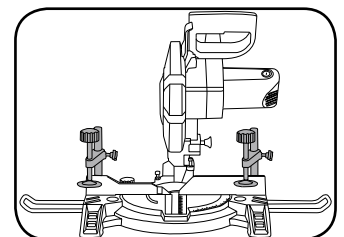

3 YEAR REPLACEMENT WARRANTY

2. SET-UP AND ADJUSTMENTS

Bench Mounting

The base of the saw has four bench mounting holes that can be used to mount it to a workbench or mitre saw stand. Use four screws or bolts (not included) to secure.

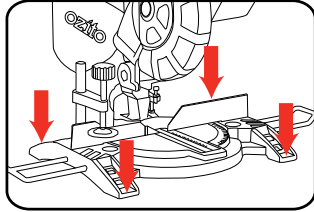

Note: If required, the Mitre Saw can be mounted onto a 13mm piece (or thicker) of plywood which can then be clamped to the work bench or mitre saw stand. This provides the flexibility to transport the Mitre Saw to other work areas.

Mitre Angle Adjustment

1. Loosen the mitre lock knob by rotating anti-clockwise

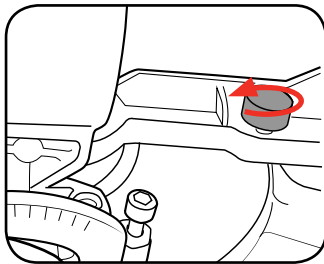

2. Rotate the mitre table to the desired angle using the mitre angle scale.

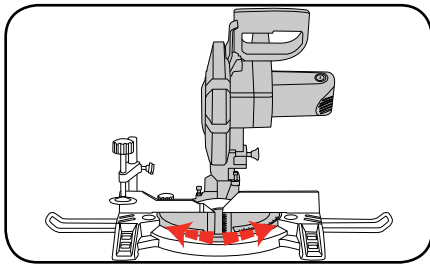

Note: The mitre table features positive click stops at 0°, 5°, 10°, 15°, 22.5°, 30°, 35°, 40° and 45° for quick setting of common mitre angles.

3. Secure the desired table angle by turning the mitre table locking knob clockwise.



WARNING! ENSURE THE MITRE LOCK KNOB IS TIGHT BEFORE MAKING A CUT. FAILURE TO DO SO MAY RESULT IN THE ROTATING TABLE MOVING DURING OPERATION AND CAUSE SERIOUS INJURY.

Bevel Angle Adjustment

1. Loosen bevel lock knob

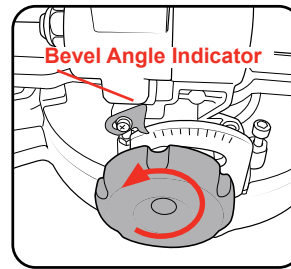

2. Tilt the cutting head to the desired bevel angle as shown by the bevel angle indicator.

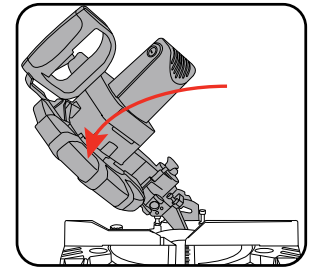

3. Tighten bevel lock knob at selected angle



WARNING! ENSURE THE BEVEL LOCK KNOB IS TIGHT BEFORE MAKING A CUT. FAILURE TO DO SO MAY RESULT IN THE CUTTING HEAD MOVING DURING OPERATION AND CAUSE SERIOUS INJURY.

Retractable Safety Guard

The lower guard provides protection to your hands and limbs when the mitre saw head is in the up position or during the operation of the saw when the saw is turned on and you are making a cut. It retracts over the upper guard as the saw is lowered into the work piece.

1. To retract the lower guard, 1 slide the release lever right with your thumb and 2 press operating handle down.

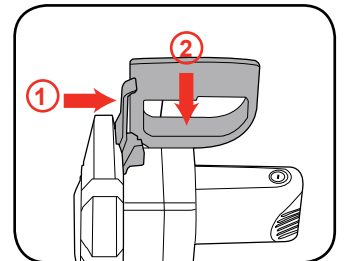

Transportation

The lock down knob is provided for holding the cutting head down

1. Press the cutting head down, 1 then 2.
2. Push the head locking pin in 3 to stop the cutting head from raising.

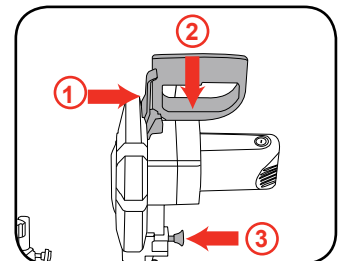

Note: Whilst transporting or storing the mitre saw.

The saw must never be used with the lock down knob locking the head down.

OPERATION

3. STRAIGHT AND ANGLE CUTTING

A straight cut is made by cutting the grain of the workpiece. A 90° straight cut is made with the mitre scale set in the 0° position

Max. cutting capacity
Wood: 55x120mm.

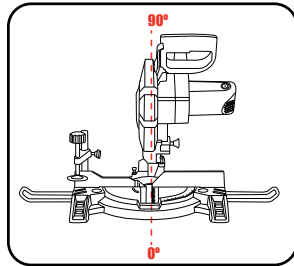
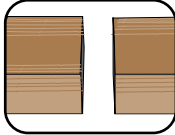

Mitre cuts are made with the mitre scale set at an angle other than 0° either to the right or left

Max. cutting capacity wood:
55x80mm

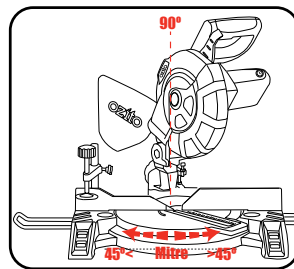
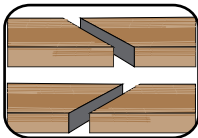

A bevel cut involves using a bevel angle other than 0° tilting saw to the left

Max. cutting capacity
Wood: 32x120mm.

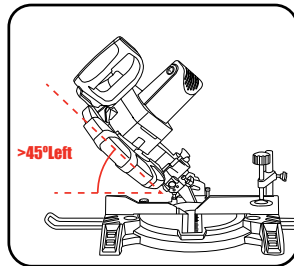
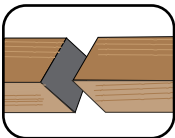

A compound mitre cut involves using a mitre angle and a bevel angle at the same time.

Max. cutting capacity wood:
32x80mm

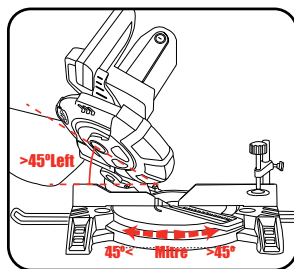
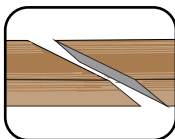

Note: To obtain good cuts when performing bevel or compound cuts the workpiece should be clamped.

CAUTION! FOR ALL TYPES OF CUTS ENSURE THE SAW IS LOCKED INTO POSITION.

4. OPERATING THE MITRE SAW



CAUTION! TO REDUCE THE RISK OF ELECTRICAL SHOCK, THE USE OF A RESIDUAL CURRENT DEVICE (RATED 30mA OR LESS) IS RECOMMENDED.



CAUTION! KEEP HANDS CLEAR OF BLADE.

Turning On and Off

1. To turn the mitre saw on, depress and hold the on/off switch
2. To turn the mitre saw off, release the on/off switch

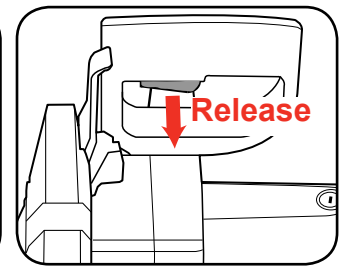
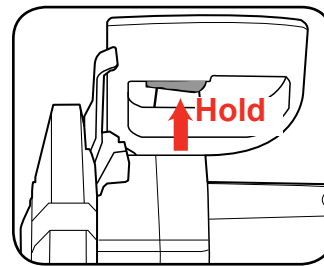

Note: Before performing a cut, ensure the blade is at full speed. Failure to do this will cause the blade to become blunt and cause the blade to lock-up.

Note: When the cut is complete allow the blade to stop rotating before raising the cutting head. This is required for safe operation of the unit to prevent personal injury.

Workpiece

Place the workpiece flat on the rotating mitre table with one edge securely against the rear fence.

Note: If the workpiece is warped, ensure the convex side is against the rear fence.

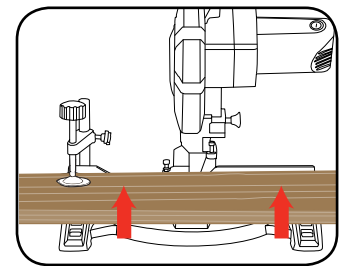

Material clamp will assist when making cuts when feeding materials from either side of the saw.

When performing a bevel or compound cut, the material clamp should be positioned on the right hand side of the fence.

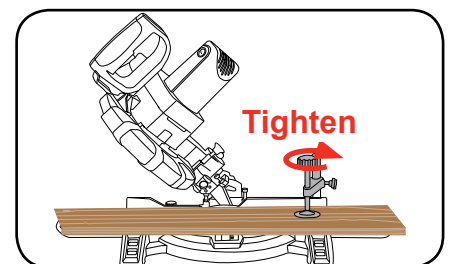

MAINTENANCE



WARNING!: BEFORE CLEANING YOUR MITRE SAW OR CARRYING OUT ANY MAINTENANCE PROCEDURE, MAKE SURE THAT THE MOTOR IS OFF AND THE TOOL DISCONNECTED FROM THE POWER SUPPLY TO PREVENT ACCIDENTAL STARTING.

Changing the Blade

CAUTION! NEVER TRY TO USE A BLADE THAT IS LARGER THAN THE STATED CAPACITY OF THE MITRE SAW. IT MIGHT COME INTO CONTACT WITH THE BLADE GUARDS AND RISK PERSONAL INJURY OR DAMAGE TO THE MITRE SAW. THIS WILL NOT BE COVERED UNDER WARRANTY.

CAUTION! NEVER USE A BLADE THAT IS TOO THICK TO ALLOW THE OUTER BLADE WASHER TO ENGAGE WITH THE FLATS ON THE SPINDLE. IT WILL PREVENT THE BLADE SCREW FROM PROPERLY SECURING THE BLADE ONTO THE SPINDLE.

CAUTION! ENSURE THAT ANY SPACERS AND SPINDLE RINGS THAT MAY BE REQUIRED SUIT THE SPINDLE AND BLADE THAT ARE FITTED.

1. Ensure the plug is disconnected from the mains power supply.

2. Ensure the cutting head is raised. If the head locking pin is locked in place, pull the head locking pin and gently raise the cutting head.

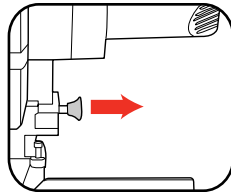

3. Using the 5mm hex key loosen and remove the screw that secures the blade bolt cover.

4. Pull the lower guard up together with the blade bolt cover. When the lower guard is positioned over the upper guard, it is now possible to access the blade bolt.

5. Insert the 6mm hex key provided into the blade bolt in the centre of the blade.

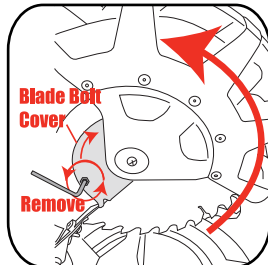

6. Depress the spindle lock button. To ensure it engages correctly, rotate the 6mm hex key until the spindle lock clicks into position.

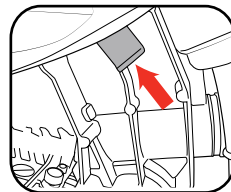

Note: The spindle lock button holds the blade in place when using the hex key to change the blade.

7. Loosen the bolt in the centre of the blade by turning the hex key **clockwise** as the blade bolt is a **left hand thread**.

8. Remove the blade bolt and the outer blade flange. The blade can now be removed by pulling away from the spindle. Put it aside ready to use in the reassembly of the new blade.

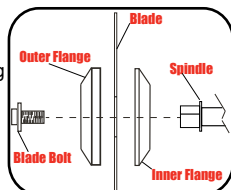

9. Fit the new blade onto the spindle taking care that the inner flange sits behind the blade.

10. Depress the spindle lock and replace the out blade flange and blade bolt. Use the hex key to tighten the blade bolt securely (tighten in an anti-clockwise direction).



WARNING!: TO ENSURE THE CORRECT BLADE ROTATION ALWAYS INSTALL THE BLADE WITH THE BLADE TEETH POINTING DOWNWARDS. ENSURE THE ARROW DIRECTION ON THE BLADE CORRESPONDS WITH THE ARROW ON THE UPPER BLADE GUARD.

11. Lower the upper guard, hold the lower guard and blade bolt cover in position while you refit & tighten the fixing screw removed in step 3.

12. Check that the blade guard operates correctly and covers the blade as the saw arm is lowered.

Carbon Brushes

When the carbon brushes wear out, the mitre saw will spark and/or stop. Discontinue use as soon as this happens. They should be replaced prior to recommencing use of the mitre saw. Carbon brushes are a wearing component of the mitre saw therefore not covered under warranty. Continuing to use the mitre saw when carbon brushes need to be replaced may cause permanent damage to the mitre saw. Carbon brushes will wear out after many uses but when the carbon brushes need to be replaced, take the mitre saw to an electrician or a power tool repairer for a quick and low cost replacement. Always replace both carbon brushes at the same time.

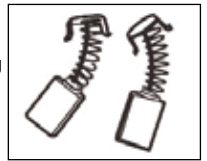

Note: Ozito Industries will not be responsible for any damage or injuries caused by the repair of the mitre saw by an unauthorised person or by mishandling of the mitre saw.

Sparking visible through the housing air vents

A small amount of sparking may be visible through the housing vents. This is normal and does not indicate a problem.

DESCRIPTION OF SYMBOLS

V	Volts	Hz	Hertz
~	Alternating current	W	Watts
min⁻¹	Revolutions or reciprocation per minute	No	No load speed
	Double insulated		Regulator compliance mark
	Warning		Wear eye protection
	Read instruction manual		Wear ear protection
	Danger! Keep hands away from blades		Wear safety gloves

SPARE PARTS

Spare parts can be ordered from the Special Orders Desk at your local Bunnings Warehouse.

For further information, or any parts not listed here, visit www.ozito.com.au or contact Ozito Customer Service:

Australia 1800 069 486

New Zealand 0508 069 486

E-mail: enquires@ozito.com.au

CARING FOR THE ENVIRONMENT



Power tools that are no longer usable should not be disposed of with household waste but in an environmentally friendly way. Please recycle where facilities exist. Check with your local council authority for recycling advice.



Recycling packaging reduces the need for landfill and raw materials. Reuse of recycled material decreases pollution in the environment. Please recycle packaging where facilities exist. Check with your local council authority for recycling advice.

ELECTRICAL SAFETY



WARNING! When using mains-powered tools, basic safety precautions, including the following, should always be followed to reduce risk of fire, electric shock, personal injury and material damage.

Read the whole manual carefully and make sure you know how to switch the tool off in an emergency, before operating the tool.

Save these instructions and other documents supplied with this tool for future reference.

The electric motor has been designed for 230V and 240V only. Always check that the power supply corresponds to the voltage on the rating plate.

Note: The supply of 230V and 240V on Ozito tools are interchangeable for Australia and New Zealand.



This tool is double insulated, therefore no earth wire is required.

If the supply cord is damaged, it must be replaced by an electrician or a power tool repairer in order to avoid a hazard.

Note: Double insulation does not take the place of normal safety precautions when operating this tool. The insulation system is for added protection against injury resulting from a possible electrical insulation failure within the tool.

Using an Extension Lead

Always use an approved extension lead suitable for the power input of this tool. Before use, inspect the extension lead for signs of damage, wear and ageing. Replace the extension lead if damaged or defective.

When using an extension lead on a reel, always unwind the lead completely. Use of an extension lead not suitable for the power input of the tool or which is damaged or defective may result in a risk of fire and electric shock.

GENERAL POWER TOOL SAFETY WARNINGS - PERSONAL SAFETY

WARNING! Read all safety warnings and all instructions. Failure to follow the warnings and instructions may result in electric shock, fire and/or serious injury. Save all warnings and instructions for future reference. The term "power tool" in the warnings refers to your mains-operated (corded) power tool or battery-operated (cordless) power tool.

1. Work area safety

- Keep work area clean and well lit. Cluttered or dark areas invite accidents.
- Do not operate power tools in explosive atmospheres, such as in the presence of flammable liquids, gases or dust. Power tools create sparks which may ignite the dust or fumes.
- Keep children and bystanders away while operating a power tool. Distractions can cause you to lose control.

2. Electrical safety

- Power tool plugs must match the outlet. Never modify the plug in any way. Do not use any adapter plugs with earthed (grounded) power tools. Unmodified plugs and matching outlets will reduce risk of electric shock.
- Avoid body contact with earthed or grounded surfaces, such as pipes, radiators, ranges and refrigerators. There is an increased risk of electric shock if your body is earthed or grounded.
- Do not expose power tools to rain or wet conditions. Water entering a power tool will increase the risk of electric shock.
- Do not abuse the cord. Never use the cord for carrying, pulling or unplugging the power tool. Keep cord away from heat, oil, sharp edges or moving parts. Damaged or entangled cords increase the risk of electric shock.
- When operating a power tool outdoors, use an extension cord suitable for outdoor use. Use of a cord suitable for outdoor use reduces the risk of electric shock.
- If operating a power tool in a damp location is unavoidable, use a residual current device (RCD) protected supply. Use of an RCD reduces the risk of electric shock.

3. Personal safety

- Stay alert, watch what you are doing and use common sense when operating a power tool. Do not use a power tool while you are tired or under the influence of drugs, alcohol or medication. A moment of inattention while operating power tools may result in serious personal injury.
- Use personal protective equipment. Always wear eye protection. Protective equipment such as dust mask, non-skid safety shoes, hard hat, or hearing protection used for appropriate conditions will reduce personal injuries.
- Prevent unintentional starting. Ensure the switch is in the off-position before connecting to power source and/or battery pack, picking up or carrying the tool. Carrying power tools with your finger on the switch or energising power tools that have the switch on invites accidents.

- Remove any adjusting key or wrench before turning the power tool on.

A wrench or a key left attached to a rotating part of the power tool may result in personal injury.

- Do not overreach. Keep proper footing and balance at all times. This enables better control of the power tool in unexpected situations.
 - Dress properly. Do not wear loose clothing or jewellery. Keep your hair, clothing and gloves away from moving parts. Loose clothes, jewellery or long hair can be caught in moving parts.
 - If devices are provided for the connection of dust extraction and collection facilities, ensure these are connected and properly used. Use of dust collection can reduce dust-related hazards.
- ## 4. Power tool use and care
- Do not force the power tool. Use the correct power tool for your application. The correct power tool will do the job better and safer at the rate for which it was designed.
 - Do not use the power tool if the switch does not turn it on and off. Any power tool that cannot be controlled with the switch is dangerous and must be repaired.
 - Disconnect the plug from the power source and/or the battery pack from the power tool before making any adjustments, changing accessories, or storing power tools. Such preventive safety measures reduce the risk of starting the power tool accidentally.
 - Store idle power tools out of the reach of children and do not allow persons unfamiliar with the power tool or these instructions to operate the power tool. Power tools are dangerous in the hands of untrained users.
 - Maintain power tools. Check for misalignment or binding of moving parts, breakage of parts and any other condition that may affect the power tool's operation. If damaged, have the power tool repaired before use. Many accidents are caused by poorly maintained power tools.
 - Keep cutting tools sharp and clean. Properly maintained cutting tools with sharp cutting edges are less likely to bind and are easier to control.
 - Use the power tool, accessories and tool bits etc. in accordance with these instructions, taking into account the working conditions and the work to be performed. Use of the power tool for operations different from those intended could result in a hazardous situation.

5. Service

- Have your power tool serviced by a qualified repair person using only identical replacement parts. This will ensure that the safety of the power tool is maintained.
- If the supply cord is damaged, it must be replaced by the manufacturer, its service agent or similarly qualified persons in order to avoid a hazard.

MITRE SAW SAFETY WARNINGS

This appliance is not intended for use by young or infirm persons unless supervised by a responsible person to ensure that they can use the appliance safely. Young children should be supervised to ensure that they do not play with the appliance.



WARNING! Before connecting a tool to a power source (mains switch power point receptacle, outlet, etc.) be sure that the voltage supply is the same as that specified on the nameplate of the tool. A power source with a voltage greater than that specified for the tool can result in serious injury to the user, as well as damage to the tool. If in doubt, do not plug in the tool.

Using a power source with a voltage less than the nameplate rating is harmful to the motor.

Your tool is double insulated for additional protection against a possible electrical insulation failure within the tool.

Always remove the plug from the mains socket before making any adjustments or maintenance, including changing the blade.

- When operating the saw, use safety equipment including safety goggles or shield, ear protection, dust mask and protective clothing including safety gloves.
- Ensure that there is adequate general or localised lighting.
- Do not use the saw unless the guards are in place.
- Do not use the saw to cut metal or masonry.
- Do not let anyone under 18 years operate this saw.
- Ensure that the operator is adequately trained in the use, adjustment and operation of the machine.
- Do not use this saw to cut firewood.
- Keep the area free of tripping hazards.
- Report faults in the machine, including guards and saw blades, as soon as they are discovered.
- Ensure that the machine is always fixed to a bench, whenever possible.
- Always stand to one side when operating the saw.
- Never use a cracked or distorted saw blade.
- When cutting round wood, use clamps that prevent the workpiece from turning on both sides of the blade.
- Never use your hands to remove sawdust, chips or waste close by the blade.
- Do not use blades of High Speed Steel (HSS blades).
- If the table insert is damaged or worn, have it replaced by a power tool repairer.
- Rags, cloths, cord and string and the like should never be left around the work area.
- Avoid cutting nails. Inspect the workpiece and remove all nails and other foreign objects before operating the saw.
- Support the work properly.
- Refrain from removing any cut-offs or other parts of the workpiece from the cutting area whilst the machine is running and the saw head is not in the rest position.

- Do not attempt to free a jammed blade before first switching off the machine.
- Do not slow or stop a blade with a piece of wood. Let the blade come to rest without assistance.
- If you are interrupted when operating the saw, complete the process and switch off before looking up.
- Periodically check that all nuts, bolts and other fixings are properly tightened.
- Do not store materials or equipment above a machine in such a way that they could fall into it.
- Always hold the saw on parts that are insulated. If you accidentally cut into hidden wiring or the saw's own cable, the metal parts of the saw will become "live". Switch off at the mains and remove the plug immediately.
- Never saw near combustible liquids or gases.
- Note the direction of rotation of the motor and the blade.
- Do not lock the movable guard in the open position and always ensure that it is working properly, freely rotating and returning to fully cover the teeth of the blade.
- Connect the saw to a dust collection device and ensure that it is operating properly. As the operator of the saw, please make sure that you understand factors that influence exposure to dust, including the type of material to be cut, the importance of local extraction and the proper adjustment of hoods/baffles/chutes of your dust extraction system. We recommend that you always wear a dust mask when operating this saw.
- Wear gloves when handling saw blades and rough materials.
- Saw blades shall be carried in a holder wherever possible.
- Select saw blades in relation to the material being cut.
- Use correctly sharpened saw blades and observe the maximum speed marked on the blade.
- Take additional care when trenching (slotting).
- The mitre saw can be safely carried by the carrying handle but only once it has been removed from the mains power and secured in the locked down position.
- Ensure that the arm is properly secure when bevelling.
- Keep the floor area around the machine level, well maintained and free of loose materials.
- Ensure that you are trained in the use, adjustment and operation of the machine.
- Do not remove any cut-offs from the cutting area until the mitre saw head is in the full upright position, the blade guard is fully enclosing the blade and the blade has come to a rest or complete stop.
- When cutting long pieces which extend well over the table width, ensure that the ends are adequately supported at the same height as the saw table top. Supports should be positioned in such a way to ensure that the workpiece does not fall to the ground once the cut has been made.

Operating Mitre Saws without the correct hearing protection may result in impairment of hearing.

A number of supports at regular intervals may be required if the workpiece is extremely long.

- Wear goggles
- Wear earmuffs
- Wear a breathing mask