

# HEATSTRIP®

OUTDOOR HEATING RANGE



**SPECIAL  
ORDERS**

HEATSTRIP® 

Available at  
**BUNNINGS**  
warehouse

**Take This Brochure** to the Special Orders Desk to place an order



## HEATSTRIP® Elegance

With superior technology and style, world-leading element design and unique "off-white" colour, the HEATSTRIP Elegance will blend in with the white ceiling in your alfresco area.

### FEATURES

- Electric radiant heater perfect for your protected alfresco area, pergola, verandah, cafe or difficult to heat indoor area
- World leading element design produces a more compact and higher output heater
- Corrosion-resistant to handle tough outdoor environments
- Convenient DIY installation of 1800W and 2400W models. 3600W model must be hardwired.
- 2 year residential and 1 year commercial warranty
- Australian designed, engineered and assembled

### TABLE LAYOUT

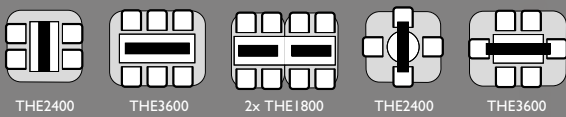

### Materials of Construction

High temperature off-white ceramic coated extruded alloy. IP55 Rated.

| MODEL   | Bunnings Item No. | RUNNING COSTS | POWER (watts) | CURRENT (amps) | DIMENSIONS (LxWxD)mm | WEIGHT (kgs) | LEAD LENGTH (mm) | PLUG | HEATING AREA (m <sup>2</sup> ) | Status  |
|---------|-------------------|---------------|---------------|----------------|----------------------|--------------|------------------|------|--------------------------------|---------|
| THE1800 | 3171310           | 45c/hr        | 1800          | 7.5            | 974x170x48.5         | 4            | 1000             | Yes  | 3-4                            | Stocked |
| THE2400 | 3171312           | 60c/hr        | 2400          | 10             | 1204x170x48.5        | 7            | 1000             | Yes  | 4-5                            | Stocked |
| THE3600 | 3171313           | 90c/hr        | 3600          | 15             | 1804x170x48.5        | 9            | 1000             | No   | 5-6                            | Stocked |

\*Running costs based on \$0.25/kWh. Heating area is for a protected outdoor site.

## HEATSTRIP® Classic

Premium quality, stylish & slimline electric radiant heaters perfect for protected outdoor and indoor applications.

### FEATURES

- Electric radiant heater ideal for your protected alfresco area, pergola, verandah, cafe or difficult to heat indoor area
- Stylish, sleek, unobtrusive design with black front profile
- Efficient, cost effective heating providing gentle warmth
- Corrosion protected for even the toughest environment
- Easy DIY installation for 3 models and multiple mounting options
- 2 year residential warranty and 1 year commercial warranty
- Australian designed, engineered and assembled

### TABLE LAYOUT



### Materials of Construction

High temperature ceramic coated extruded alloy. IP55 Rated.

| MODEL    | Bunnings Item No. | RUNNING COSTS | POWER (watts) | CURRENT (amps) | DIMENSIONS (LxWxD)mm | WEIGHT (kgs) | LEAD LENGTH (mm) | PLUG | HEATING AREA (m <sup>2</sup> ) | Status        |
|----------|-------------------|---------------|---------------|----------------|----------------------|--------------|------------------|------|--------------------------------|---------------|
| THH1500A | 3170731           | 37c/hr        | 1500          | 6.3            | 924x165x48           | 5            | 1000             | Yes  | 2-3                            | Special Order |
| THH1800A | 3170732           | 45c/hr        | 1800          | 7.5            | 1104x165x48          | 6            | 1000             | Yes  | 3-4                            | Stocked       |
| THH2400A | 3170733           | 60c/hr        | 2400          | 10             | 1364x165x48          | 7            | 1000             | Yes  | 4-5                            | Stocked       |
| THH3200A | 3170734           | 80c/hr        | 3200          | 13.3           | 1774x165x48          | 9            | 1000             | No   | 5-6                            | Stocked       |

\*Running costs based on \$0.25/kWh. Heating area is for a protected outdoor site.

## HEATSTRIP® Max

High performance, low glow electric radiant heaters for tough residential and commercial heating projects.

### FEATURES

- High temperature electric radiant heater ideal for higher ceilings or more exposed locations
- Unique "low glow" Incoloy element – no more blinding light
- Commercial grade quality and construction
- Corrosion resistance provided by the anodized alloy casing
- DIY (THX 2400) or hard wired (THX 3600)
- 2 year warranty
- Australian designed, engineered and assembled

### TABLE LAYOUT

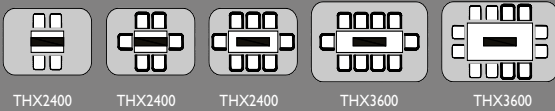

### Materials of Construction

Anodised alloy casing and end caps, chromed grill. IPX5 Rated.



| MODEL   | Bunnings Item No. | RUNNING COSTS | POWER (watts) | CURRENT (amps) | DIMENSIONS (LxWxD)mm | WEIGHT (kgs) | HEATING* AREA (m <sup>2</sup> ) | Status                                |
|---------|-------------------|---------------|---------------|----------------|----------------------|--------------|---------------------------------|---------------------------------------|
| THX2400 | 3170735           | 60c/hr        | 2400          | 10             | 854x170x80           | 6            | 10                              | Supplied with lead & plug DIY Stocked |
| THX3600 | 3170736           | 90c/hr        | 3600          | 15             | 1184x170x80          | 8            | 15                              | Must be hard wired Special Order      |

\*Running costs based on \$0.25/kwH. Heating area for an enclosed outdoor area.

## Optional Controllers

### DIY (TT-MTR-PLUG)

TT-MTR-PLUG timer switch provides an easy DIY installation and remote control of plug-in heaters.

- Plug-in DIY timer switch
- On/Off function with LED indicators
- Automatic timer – 1 / 2 / 4 hour options
- Remote control included
- Max. 10 amps

| Product No. | Bunnings Item No. | Status  |
|-------------|-------------------|---------|
| TT-MTR-PLUG | 3171309           | Stocked |

### HARDWIRED (TT-MTM)



TT-MTM wall mounted controller and remote control provides ON/OFF control, 3 heat options and a timer setting.

- On/Off function with LED indicators
- 3 Heat settings - High / Medium / Low
- Automatic timer control - 1/2/4 hour options
- Remote control included
- Suitable for operation of single or multiple heaters
- Must be hard-wired. Maximum 16 amps direct wired capacity (for additional heaters, use a relay/contacter)

| Product No. | Bunnings Item No. | Status  |
|-------------|-------------------|---------|
| TT-MTM      | 3170737           | Stocked |



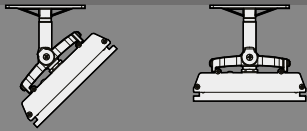
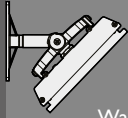

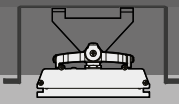
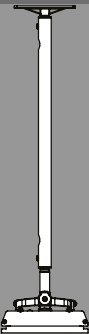
|                 |   |   |  |
|-----------------|---|---|--|
|                 |  <p>Ceiling Mounts</p>  <p>Wall Mount</p>  <p>Chain/Wire Suspension*</p> |  <p>Flush Mount Enclosure</p> |  <p>Extension Mount Bracket</p> |
|                 | Standard Bracket [*Chain not included]  | Flush Mount Enclosure<br>Opt. Accessories   | Extension Mount Bracket<br>Opt. Accessories  |
| <b>ELEGANCE</b> | 3171585<br>(Included with heater)   | 3171576 (for THE1800)<br>3171577 (for THE2400)<br>3171578 (for THE3600)   | 3171579 (300mm)<br>3171580 (600mm)<br>3171582 (900mm)<br>3171583 (1200mm)  |
| <b>CLASSIC</b>  | 3171584<br>(Included with heater)   | 3170738 (for THH1500A)<br>3170740 (for THH1800A)<br>3170741 (for THH2400A)<br>3170742 (for THH3200A)            | 3170745 (300mm)<br>3170746 (600mm)<br>3170748 (900mm)<br>3170749 (1200mm)  |
| <b>MAX</b>      | 31711315<br>(Included with heater)  | 3180684 (for THX2400)<br>3180686 (for THX3600)  | 3171586 (300mm)<br>3171587 (600mm)<br>3171588 (900mm)<br>3171589 (1200mm)  |

All items are Special Order

## Which product do I need?

| APPLICATION  | ELEGANCE (THE) | CLASSIC (THH-A) | MAX (THX) |
|--|----------------|-----------------|-----------|
| Outdoor Heating – undercover, well protected area with ceiling height less than 2.7m (al-fresco, verandah, café)           | ✓              | ✓               | ✓         |
| Outdoor Heating – undercover, well protected area with ceiling height from 2.7m to 3.0m (al-fresco, verandah, café)        |                |                 | ✓         |
| Outdoor Heating – exposed area (al-fresco,café, verandah, balcony)   |                |                 | ✓         |
| Indoor Insulated areas – commercial (classrooms, offices, nursing homes,hospitals) residential (shed, garage etc)          | ✓              | ✓               |           |
| Indoor Open-nu-insulated areas requiring spot heating - factory, halls, warehouse, workshop, shed, garage, sports facility | ✓              | ✓               | ✓         |

## Mounting Heights

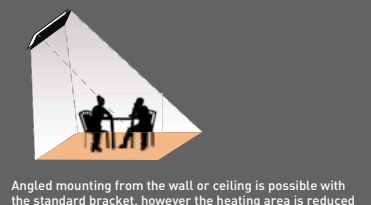
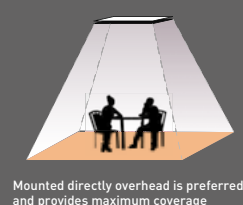
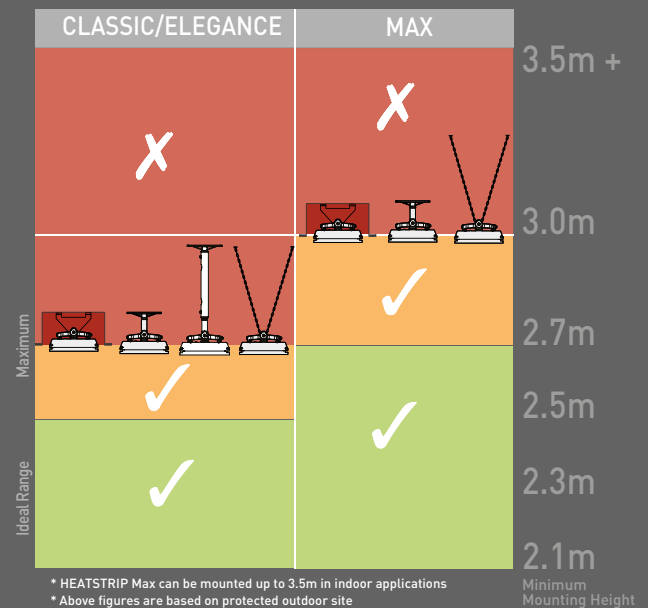



# HEATSTRIP® Portable Electric Heater (THH1800AP)

**NEW**



The new HEATSTRIP electric heater is the classy and refined solution, for when a portable, easy DIY electric heating option is required. Incorporating a sleek and robust stand with a 1800W HEATSTRIP Classic heater, it is ideal for spot heating of tables, lounges, entertaining areas and work stations, both indoors and outdoors.

## FEATURES

- Stylish, high quality portable, free-standing outdoor heater stand
- Ideal for alfresco areas, balconies, apartments & hospitality (internal & external use)
- Concealed power cable ensures a sleek appearance. Black, no glow heater
- Components are sub-assembled for easy DIY installation
- In-built wheels for easy portability, perfect for residential and commercial applications
- Corrosion protected for even the toughest environment.
- 2 year residential and 1 year commercial warranty

### Materials of Construction

Heater: High temperature ceramic coated extruded alloy. IP55 rated  
Stand: E-coated mild steel with powder coat finish

| MODEL     | Bunnings Item No. | RUNNING COSTS | POWER (watts) | CURRENT (amps) | DIMENSIONS (WxDxH)mm | WEIGHT (kgs) | HEATING AREA (m <sup>2</sup> ) | LEAD LENGTH (mm) | Status  |
|-----------|-------------------|---------------|---------------|----------------|----------------------|--------------|--------------------------------|------------------|---------|
| THH1800AP | 3171574           | 45c/hr        | 1800          | 7.5            | 1104x670x2150        | 22           | 3-4                            | 3000             | Stocked |

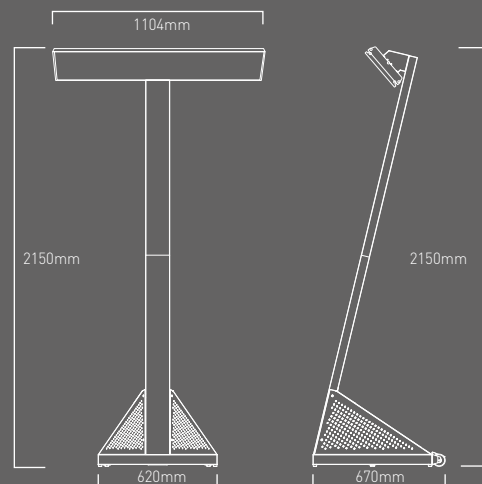

Note: Connection to power source is at bottom of stand, not shown in image.

# HEATSTRIP® Portable LPG Outdoor Heater (TGH34PL)

**NEW**



**Optional heater cover available (TGHCOVER / 3171575)**

The new HEATSTRIP portable LPG heater incorporates world leading design, quality, heat performance and efficiency to provide a stylish, robust and elegant solution for your outdoor area, alfresco, balcony, patio etc.

## FEATURES

- 34 MJ, 4 tile commercial quality ceramic burner  
To be used with 9kg LPG bottle (not included)
- Manual integrated Piezo ignition, with tilt safety switch and flame failure device. Fully concealed gas pipes and bottle
- In-built wheels for easy portability and storage
- Components are sub-assembled for easy DIY installation
- High/Low heating output. Directional heat performance allows you to heat exactly where you want it
- Protective grille and reflector included as standard, to guarantee safe operation. Reflector design ensures that only a minimum of 500mm overhead clearance is required
- 2 year residential and 1 year commercial warranty

### Materials of Construction

E-coated mild steel with powder coat finish.  
Grill & reflector with extra high temperature protection.

| MODEL   | Bunnings Item No. | TILES | MJ | IGNITION      | DIMENSIONS (WxDxH)mm | RUNNING COST*                   | WEIGHT (kg) | HEATING AREA (sqm <sup>2</sup> ) | Status  |
|---------|-------------------|-------|----|---------------|----------------------|---------------------------------|-------------|----------------------------------|---------|
| TGH34PL | 3171572           | 4     | 34 | Manual, Piezo | 650x670x2118         | \$1.60 on high<br>\$1.12 on low | 31.5        | 16                               | Stocked |

\* Based on \$20 per gas bottle refill and run time of 12.5 hrs on high / 18 hrs on low

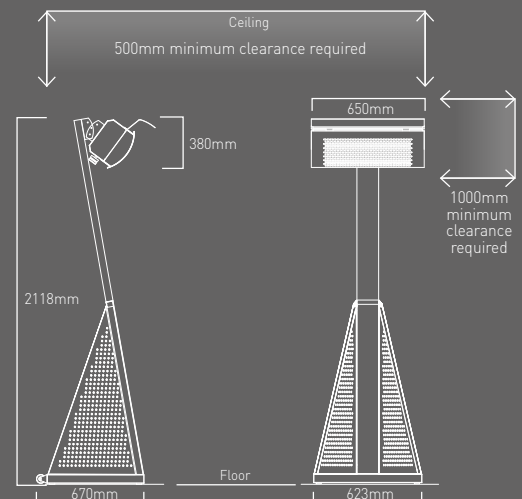

Note: Suitable for outdoor use only.



# HEATSTRIP® Wall Mounted Natural Gas Heater (TGH34WN)

**NEW**



**Wall mounting bracket**



**ON / OFF switch with electronic ignition**



**4 tile commercial ceramic burner**

The new HEATSTRIP Wall Mounted Natural Gas (NG) heater is a stylish addition to any outdoor area, where mains Natural Gas is preferred. World class design aesthetics, heat output and performance, for both residential and commercial applications.

## FEATURES

- 34MJ, 4 tile commercial quality ceramic burner, for connection to mains Natural Gas (NG)
- Electronic battery ignition with micro-switch On/Off operation and stainless steel pull cords. Electrical connection not required
- Protective grille and reflector included as standard, to guarantee safe operation. Reflector design ensures that only a minimum of 500mm overhead clearance is required (add TGHSHIELD for 300mm clearance)
- Wall mounting bracket allows for multiple mounting angles, and is extremely robust to provide strength and support
- Conversion to use with LPG is optional (Model TGH34WLPG)
- 2 year residential and 1 year commercial warranty

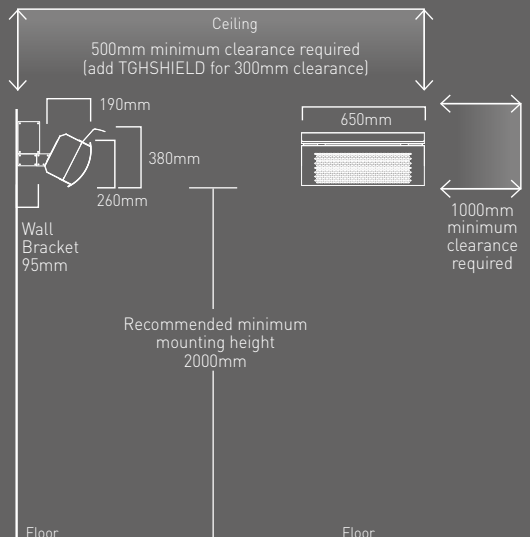

## Materials of Construction

E-coated mild steel with powder coat finish.  
Grille & reflector with extra high temperature protection.

| MODEL   | Bunnings Item No. | TILES | MJ | IGNITION           | DIMENSIONS (WxDxH)mm | RUNNING COST                    | WEIGHT (kg) | HEATING AREA (sqm <sup>2</sup> ) | Status        |
|---------|-------------------|-------|----|--------------------|----------------------|---------------------------------|-------------|----------------------------------|---------------|
| TGH34WN | 3171571           | 4     | 34 | Electronic Battery | 650x190x380          | \$0.68/hr<br>(based on a 2¢/MJ) | 11.5        | 16                               | Special Order |

# HEATSTRIP®

OUTDOOR HEATERS

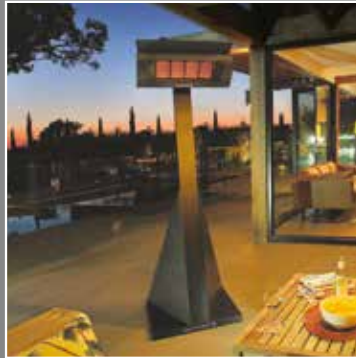
## HEATSTRIP® by Thermofilm Australia Pty Ltd

HEATSTRIP is a range of world class electric and gas heaters designed for both indoor and outdoor applications. Awarded the coveted Australian Business Award for Product Value and Victorian Manufacturer of the Year. HEATSTRIP electric range is proudly designed, engineered and assembled in Australia, and exported to the world.



Thermofilm Australia Pty Ltd  
 17 Johnston Court, Dandenong South, Victoria 3175, Australia.  
 p: (03) 9562 3455 | f: (03) 9548 3979 | e: sales@thermofilm.com.au  
[www.facebook.com/ThermofilmAustralia](http://www.facebook.com/ThermofilmAustralia)

[heatstrip.com.au](http://heatstrip.com.au)

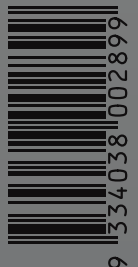

BUNNINGS 02/2017/RV1