

Uni-Pier

Selection Guide

2013



Product Selection Guide

Uni-Piers are a smart but simple piercing system and designed to replace brick piers, concrete or timber stumps that in the past have been traditionally used as sub-floor supports.

Uni-Piers are a two part system each being prefabricated units comprising:-

- a “head” that has a built-in ant cap and a cleat for securing either timber or steel bearers, and
- a square tubular steel (SHS) post to which is welded a base plate that is anchored to the concrete footing or pad.

The final stage of the manufacturing process is hot dip galvanising of the units for life-long durability making them suitable to be used in coastal environments.

When assembled, the piers are adjustable to the desired height, so eliminating inaccuracies that are often evident in concrete footings or pads.

Once positioned and the height determined, the Uni-Pier head and post are normally secured with a number of 14-20x22 to AS 3566 Class 4 self drilling and tapping screws in accordance with the design requirement (refer page 14).

Uni-Piers are non-combustible and will not rot, warp, shrink or harbour termites.

Uni-Piers are designed to suit any normal domestic floor design and are able to support most roof and wall loads in all wind areas and are suitable for up to 5m fall in terrain.

Uni-Piers comply with BCA and relevant Australian Building codes.

To Determine the Pier Height

Uni-Piers are supplied in incremental lengths of 200mm.

For Builders Grade piers (65 x 65) the length range is 200mm to 4000mm.

For Heavy duty piers (75 x 75) the length range is 200mm to 5000mm.

Base Plate to Top of Footing Detail

To determine the height of the piers required; establish the distance from the top of each footing to the underside of each bearer then select the post to the nearest 200mm BELOW the dimension.

Example

- Measured height – 675mm = 600mm Uni-Pier
- Measured height – 725mm = 600mm Uni-Pier
- Measured height – 1730mm = 1600mm Uni-Pier

Base Plate Cast into Footing Detail

To determine the height of Uni Piers required in this application, the depth of footing needs to be taken into account, allowing a MINIMUM of 150mm cover UNDERNEATH the bottom of the Uni-Pier baseplate. Actual embedment of the pier into concrete should be a MINIMUM of 300mm.

Such footings must be designed by a suitably qualified engineer.

For both applications, see diagrams on page 15.

Steps for Selecting Piers

- 1** Determine wind classification from Wind Region Map of Australia on page 3, or use recommended wind classification provided by a registered engineer.
- 2** Refer to Wind Classification System table on page 3 and apply selected region (eg A), then select the Topographic Category that best fits the topographic description (eg T1), then choose the terrain category (TC) as indicated in the legend, then determine the amount of shielding to the site, then finally select the wind classification (eg N2).
- 3** Determine pier height (as described) and bracing requirement on pages 4 and 5.

Note: Bracing may not be required where the base of a building is built with masonry walls.
- 4** Proceed to relevant page for Uni-Pier Load Capacity tables (ie Builders Grade piers or Heavy Grade piers for wind classifications).

Builders Grade for N1, N2 & N3 -	pages 6&7
Heavy Grade for N1, N2 & N3 -	pages 8&9
Builders Grade for C1 & C2 -	pages 10&11
Heavy Grade for C1 & C2 -	pages 12&13

Follow instructions under “USING THIS SPECIFICATION” of each section to determine pier locations and ensure correct types are chosen.
- 5** For details of fixing heads to posts and securing posts to footings, refer to Connection Tables and Details on pages 14 and 15.

The intent of building construction, particularly in high wind areas, is to ensure the structure can transfer wind forces to the ground with an adequate margin of safety and to prevent the building from (a) collapsing, (b) being lifted, or, (c) sliding off its foundations.

To resist these forces, the following is necessary:

- An effective anchorage system, where the roof is connected by the walls to the footings by a series of connections; and
- A bracing system to prevent horizontal collapse due to wind forces; and
- Continuity of the system where each structural element is interlocked to its adjoining element.

Wind Region Map of Australia

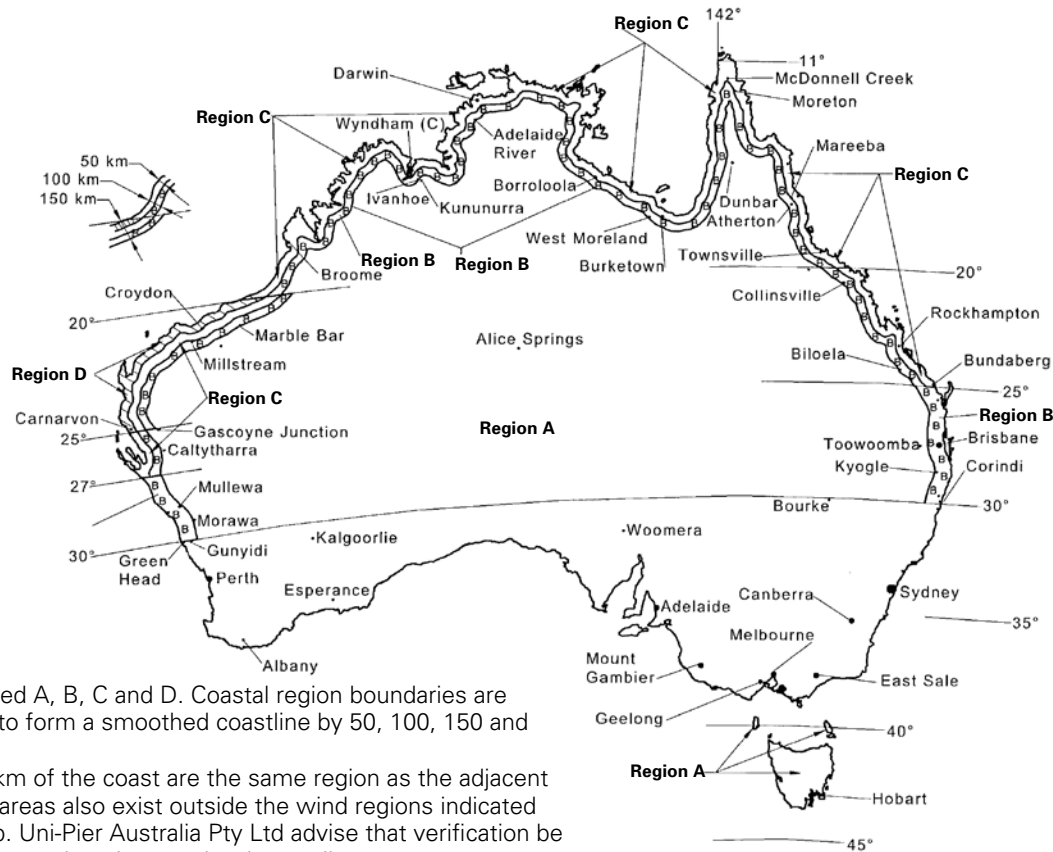

Notes.

Regions are marked A, B, C and D. Coastal region boundaries are smooth lines set to form a smoothed coastline by 50, 100, 150 and 200km.

Islands within 50km of the coast are the same region as the adjacent coast. High wind areas also exist outside the wind regions indicated on the above map. Uni-Pier Australia Pty Ltd advise that verification be sought from a structural engineer or local council.

Wind Classification System - from wind region map and site conditions

Legend

- FS = full shielding
- PS = partial shielding
- NS = no shielding
- N = non-cyclonic
- C = cyclonic
- N/A = not applicable - beyond the scope of Uni-Pier design
- TC = terrain category

Terrain Category (this a guide only of category classification that surrounds or is likely to surround the site with 5 years)

- 3 Level wooded country, suburban buildings
- 2.5 Lightly wooded, long grass (600mm), some buildings
- 2 Rough, open water surfaces, isolated trees
- 1 Flat natural surface

Notes describing Topographic Class are a guide only. Site specific advice should be sought from a structural engineer.

Wind region (from map)		Wind class															
		TC	Topographic class														
			T1 Flat areas, slopes less than 1:10, lower third of any hill, middle third of hill less than 1:5			T2 Sloping ground greater than 1:5 and less than 1:3			T3 Sloping ground greater than 1:3			T4 Top of slope less than 1:3			T5 Top of steep hill greater than 1:3		
FS	PS	NS	FS	PS	NS	FS	PS	NS	FS	PS	NS	FS	PS	NS			
A	3	N1	N1	N1	N2	N2	N2	N2	N3	N3	N2	N3	N3	N3	N3	N4	
	2.5	N1	N1	N2	N2	N3	N3	N2	N3	N3	N3	N3	N4	N3	N4	N4	
	2	N1	N2	N2	N2	N3	N3	N3	N3	N3	N3	N3	N4	N4	N4	N4	
	1	N2	N3	N3	N3	N3	N4	N3	N4	N4	N4	N4	N4	N4	N4	N5	
B	3	N2	N2	N3	N3	N3	N4	N3	N4	N4	N4	N4	N4	N4	N5	N5	
	2.5	N2	N3	N3	N3	N4	N4	N3	N4	N4	N4	N4	N5	N4	N5	N5	
	2	N2	N3	N3	N3	N4	N4	N4	N4	N5	N4	N5	N5	N5	N5	N6	
	1	N3	N4	N4	N4	N5	N5	N4	N5	N5	N5	N5	N6	N5	N6	N6	
C	3	C1	C1	C2	C2	C2	C3	C2	C3	C3	C3	C3	C3	C3	C4	C4	
	2.5	C1	C2	C2	C2	C3	C3	C3	C3	C3	C3	C4	C4	C4	C4	N/A	
	1,2	C2	C2	C2	C2	C3	C3	C3	C4	C4	C3	C4	C4	C4	N/A	N/A	
	3	C2	C3	C3	C3	C4	C4	C3	C4	C4	C4	N/A	N/A	N/A	N/A	N/A	
D	2.5	C2	C3	C3	C3	C4	C4	C4	N/A	N/A	C4	N/A	N/A	N/A	N/A	N/A	
	1,2	C3	C3	C4	C4	N/A	N/A	C4	N/A	N/A	N/A	N/A	N/A	N/A	N/A	N/A	

Important Note. Uni-Pier products are designed for general construction (ie residential). Uni-Pier Australia Pty Ltd recommend that advice be sought from a structural engineer especially when wind zones would typically include N6, C3 and C4.

Sub Floor Bracing using 50 x 50 x2.5mm DURAGAL angle

Cross bracing must be used between Uni-Piers in both directions of the pier's grid pattern, with each direction being designed separately.

For this application of bracing, 50 x 50 x 2.5mm Duragal angle is recommended. The bracing is typically connected to Uni-Piers with two Self-drilling and tapping screws (14 – 20x22 to AS3566 Class 4) at each end and located no more than 20mm from the top or bottom of the Uni-Pier. The intersection of the braces is fixed together with one screw.

It is important that bracing shown on Elevation 1 (below) resists wind loads from Direction 2; and Elevation 2 resists wind loads from Direction 1.

The tables contain herein apply for cross bracing between steel Uni-Piers up to 3.6m in height for single storey houses.

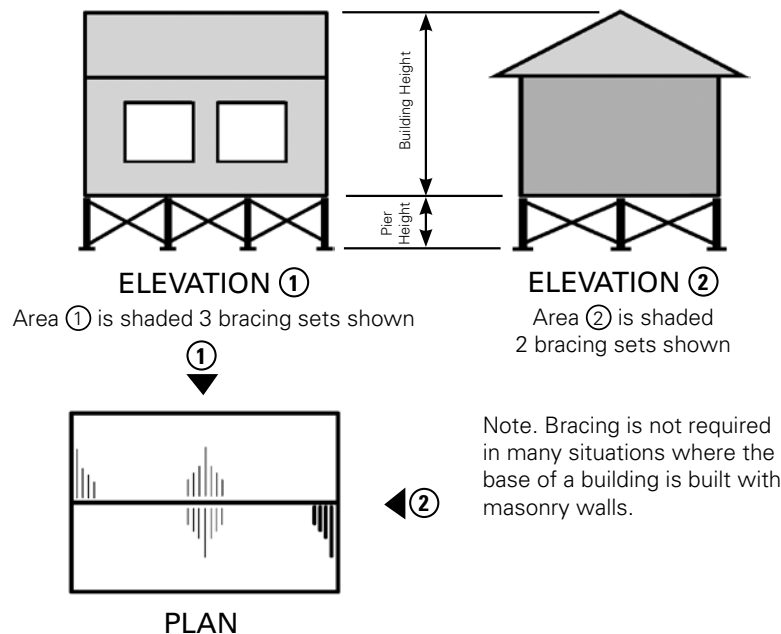

Calculation of Racking Forces at Floor Level

The table below applies for cross braces between Uni-Piers
 A = Area of house elevation facing wind in square metres
 ie width of house x height (including roof height)

Wind Area Classification AS 4055	Ultimate Limit State Velocity m/sec	Racking Force Formula kN
N1	34	0.83 x A
N2	40	0.96 x A
N3	50	1.80 x A
N4	61	2.64 x A

NB. Bracing for use in N5 (C1) wind classification should be determined by a suitably qualified engineer.

Table for Capacity of Duragal angle 50 x 50 x 2.5mm

Racking force capacity for each set of cross braces (kN)

Pier Spacing in direction of brace (m)	Pier Height (m)			
	0.9m	1.8m	2.7m	3.6m
2.0m	13.6	11.1	8.9	7.3
3.0m	14.4	12.8	11.1	9.6
4.0m	14.6	13.7	12.4	11.6
4.8m	14.8	14.1	13.2	12.1

Steps for Selection

1 Find Areas

Calculate Area ① and Area ② (as indicated), being length x height.

If a house is L shaped, divide it into two separate blocks and calculate the wind loading on each block.

2 Calculate Racking Forces at Floor Level

For Elevation ① and then for Elevation ② determine the Racking Force by applying the formula according to the required Wind Area Classification.

3 Determine the Number of Bracing Sets required

By referring to the Table for Capacity of Duragal Angle (refer table), divide the value as determined by Uni-Pier height and Spacing into the calculated Racking Force for both Elevations, as per Step 2.

This will result in the number of bracing sets required.

Calculation Example

1. Assume wind area N2
2. Building area facing wind direction:
3. 16m wide x 4.5m high
(wall height plus roof height) = 72m²
4. Calculation from table racking force:
0.96 x 72 = 69.12kN
5. Assume Pier Spacing: 2.0m
6. Assume Pier Height: 1.8m
7. Capacity of each cross brace set
(refer below table) = 11.1kN
8. Total number of braces required in sub-floor in direction of wind force:
9. 69.12 divided by 11.1 = 6.2. Use 7 bracing sets.

Sub Floor Bracing using Uni-Brace®

Uni-Pier has now developed a bracing system that is pre-assembled, convenient, easy to adjust on site and requires no cutting. The only tools required for installation are a power drill with driver bits capable of installing 14-20x22 self-drilling and tapping screws into steel and clamps to hold the assembly in position during installation.

Further information including installation recommendations, can be found in the Uni-Brace® brochure downloaded from www.unipier.com.au, or available from your Uni-Pier supplier.

The tables below apply to Uni-Brace being installed sub-floor between Uni-Piers to a maximum height of 3.6m and for single storey houses. Uni-Braces® are available in four nominal sizes from 900mm to 1800mm.

	UBR9	UBR12	UBR15	UBR18
Nominal Supplied Length	900mm	1200mm	1500mm	1800mm
Minimum Extension	1640mm	1940mm	2240mm	2540mm
Maximum Extension	2100mm	3300mm	4500mm	5700mm

Uni-Brace® Selection Table

To further assist selection, the following table can also be used as a guide to determine Uni-Brace® size requirements. This table assumes that posts to be braced are on level ground and are the same height.

		MAXIMUM POST SPACING (GRID)													
		1.2	1.5	1.8	2.1	2.4	2.7	3.0	3.3	3.6	3.9	4.2	4.5	4.8	
MAXIMUM POST HEIGHT	0.6	N/A	N/A	UBR9	UBR12	UBR12	UBR12	UBR12	UBR15	UBR15	UBR15	UBR15	UBR15	UBR18	
	0.9	N/A	UBR9	UBR9	UBR12	UBR12	UBR12	UBR12	UBR15	UBR15	UBR15	UBR15	UBR18	UBR18	
	1.2	UBR9	UBR9	UBR12	UBR12	UBR12	UBR12	UBR12	UBR15	UBR15	UBR15	UBR15	UBR18	UBR18	
	1.5	UBR9	UBR9	UBR12	UBR12	UBR12	UBR12	UBR15	UBR15	UBR15	UBR15	UBR15	UBR18	UBR18	
	1.8	UBR12	UBR12	UBR12	UBR12	UBR12	UBR12	UBR15	UBR15	UBR15	UBR15	UBR18	UBR18	UBR18	
	2.1	UBR12	UBR12	UBR12	UBR12	UBR12	UBR15	UBR15	UBR15	UBR15	UBR15	UBR18	UBR18	UBR18	
	2.4	UBR12	UBR12	UBR12	UBR12	UBR15	UBR15	UBR15	UBR15	UBR15	UBR15	UBR18	UBR18	UBR18	
	2.7	UBR12	UBR12	UBR12	UBR15	UBR15	UBR15	UBR15	UBR15	UBR15	UBR18	UBR18	UBR18	UBR18	
	3.0	UBR12	UBR15	UBR15	UBR15	UBR15	UBR15	UBR15	UBR15	UBR18	UBR18	UBR18	UBR18	UBR18	
	3.3	UBR15	UBR15	UBR15	UBR15	UBR15	UBR15	UBR15	UBR18	UBR18	UBR18	UBR18	UBR18	N/A	
3.6	UBR15	UBR15	UBR15	UBR15	UBR15	UBR15	UBR18	UBR18	UBR18	UBR18	UBR18	N/A	N/A		

Allow to overlap post. Refer to Step 1.

Uni-Brace® Quantity Table

The following table is to determine the number of Uni-Braces® required on each grid, assuming a single storey house and a maximum roof pitch of 35 degrees. Ensure that correct wind classification is applied.

Pier Spacing Grid Maximum	Wind Class* N1	Wind Class* N2	Wind Class* N3	Wind Class* N4
2.0m	1 Uni-Brace® every 2nd row	1 Uni-Brace® every 2nd row	1 Uni-Brace® every row	1 Uni-Brace® every row
3.0m	1 Uni-Brace® every 2nd row	1 Uni-Brace® every row	1 Uni-Brace® every row	2 Uni-Braces® every row
4.0m	1 Uni-Brace® every row	1 Uni-Brace® every row	2 Uni-Braces® every row	2 Uni-Braces® every row
4.8m	1 Uni-Brace® every row	2 Uni-Braces® every row	2 Uni-Braces® every row	3 Uni-Braces® every row

* If unsure of wind classification consult a registered structural engineer.

NB: Bracing of Uni-Piers is not required in many situations where the base of a building is built with masonry walls.

UNI-PIER LOAD CAPACITY SPECIFICATION

Builder's Grade Uni-Piers (65 x 65 x 2) - FOR WIND CLASSIFICATION N1, N2, N3

USING THIS SPECIFICATION

Uni-Piers are to be set in a square grid pattern, except for the verandah. To obtain your maximum pier centres, follow the steps below.

1. Choose the pier condition in question from the pier plan below.
2. Using the number indicated by the pier condition, refer to the corresponding table set on the right.

3. Determine whether the job has *timber* or *closed steel* section bearers:

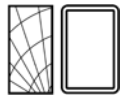

or C-section steel bearers:





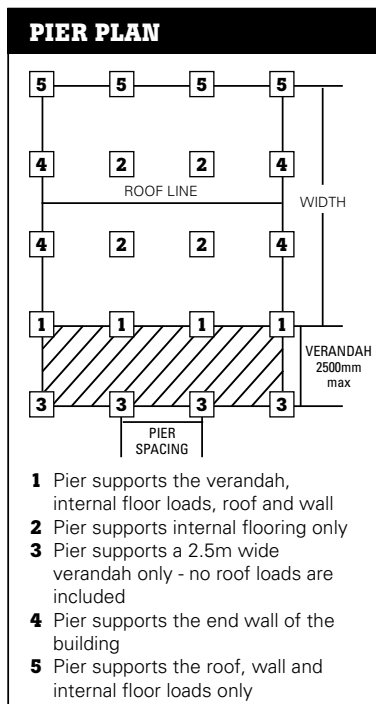

4. Select a *roof* width in metres
5. Choose your *maximum pier height* in metres
6. Finally, determine if the job has a sheet or tile roof, with or without bracing.
7. All brickwork is to be supported on concrete footings only.
8. Capacity tables are based on assumption that piers are spaced the same in both directions. (ie X=Y in Pier Location Diagram)



Pier Location	Bearer Type	Roof Width	Max. Pier Height	N1 & N2				N3			
				Pier Grid Spacing (m) (MAXIMUM)				Pier Grid Spacing (m) (MAXIMUM)			
				Sheet		Tile		Sheet		Tile	
				No Brace	Brace	No Brace	Brace	No Brace	Brace	No Brace	Brace
1	Timber	9.0	0.6	5.4	5.4	4.9	4.9	5.4	4.7	4.9	4.2
			1.3	4.9	5.2	4.4	4.4	4.9	4.1	4.4	3.7
			2.0	4.0	4.1	3.5	3.5	4.0	3.2	3.5	2.9
		2.8	3.0	2.9	2.6	2.5	3.0	2.2	2.6	2.0	
		3.6	2.2	2.0	1.8	1.7	2.2	1.6	1.8	1.4	
		12.6	0.6	5.1	5.4	4.4	4.5	5.1	4.3	4.4	3.7
	1.3	4.6	4.7	4.0	4.0	4.6	3.7	4.0	3.2		
	2.0	3.7	3.7	3.1	3.1	3.7	2.9	3.1	2.5		
	2.8	2.7	2.6	2.3	2.1	2.7	2.0	2.3	1.7		
	3.6	2.0	1.8	1.6	1.4	2.0	1.4	1.6	1.2		
	16.2	0.6	4.8	4.9	4.0	4.0	4.8	3.9	4.0	3.3	
	1.3	4.3	4.3	3.6	3.5	4.3	3.4	3.6	2.9		
2.0	3.5	3.4	2.9	2.7	3.5	2.6	2.9	2.2			
2.8	2.5	2.3	2.0	1.9	2.5	1.8	2.0	1.5			
3.6	1.8	1.6	1.4	1.3	1.8	1.2	1.4	1.0			
2	Timber	9.0	0.6	3.7	3.7	3.2	3.2	3.7	3.0	3.2	2.6
			1.3	3.4	3.4	3.0	2.9	3.4	2.7	3.0	2.3
			2.0	2.9	2.8	2.5	2.4	2.9	2.2	2.5	1.9
		2.8	2.2	2.1	1.9	1.8	2.2	1.7	1.9	1.4	
		3.6	1.7	1.6	1.5	1.4	1.7	1.2	1.5	1.0	
		12.6	0.6	3.4	3.4	2.9	2.8	3.4	2.6	2.9	2.3
	1.3	3.1	3.0	2.6	2.5	3.1	2.3	2.6	2.0		
	2.0	2.7	2.5	2.2	2.1	2.7	2.0	2.2	1.7		
	2.8	2.0	1.9	1.7	1.5	2.0	1.4	1.7	1.2		
	3.6	1.6	1.4	1.3	1.1	1.6	1.1	1.3	0.9		
	16.2	0.6	3.2	3.1	2.6	2.5	3.2	2.4	2.6	2.0	
	1.3	2.9	2.7	2.3	2.2	2.9	2.1	2.3	1.8		
2.0	2.4	2.3	2.0	1.8	2.4	1.8	2.0	1.5			
2.8	1.9	1.7	1.5	1.3	1.9	1.3	1.5	1.1			
3.6	1.4	1.2	1.1	1.0	1.4	1.0	1.1	0.8			
3	Timber	N/A	0.6	5.9	5.6	5.9	5.6	5.9	5.5	5.9	5.5
			1.3	5.5	5.2	5.5	5.2	5.5	5.0	5.5	5.0
			2.0	4.8	4.4	4.8	4.4	4.8	4.2	4.8	4.2
		2.8	4.0	3.5	4.0	3.5	4.0	3.2	4.0	3.2	
		3.6	3.2	2.7	3.2	2.7	3.2	2.4	3.2	2.4	
		16.2	0.6	4.6	4.2	4.6	4.2	4.6	4.0	4.6	4.0
	1.3	4.3	3.9	4.3	3.9	4.3	3.6	4.3	3.6		
	2.0	3.9	3.5	3.9	3.5	3.9	3.2	3.9	3.2		
	2.8	3.3	2.8	3.3	2.8	3.3	2.5	3.3	2.5		
	3.6	2.8	2.2	2.8	2.2	2.8	1.8	2.8	1.8		
	3	C-section	2.5	0.6	4.1		3.9		4.1		3.9
				1.3	3.8		3.6		3.8		3.6
2.0				3.3		3.2		3.3		3.2	
2.8			2.7		2.6		2.7		2.6		
3.6			2.2		2.1		2.2		2.1		
16.2			0.6	3.2		3.0		3.2		3.0	
1.3		2.9		2.8		2.9		2.8			
2.0		2.7		2.5		2.7		2.5			
2.8		2.2		2.2		2.2		2.2			
3.6		1.9		1.9		1.9		1.9			
C-section		N/A	0.6		4.4			4.4			
			1.3		4.1			4.1			
	2.0			3.6			3.6				
	2.8		2.9			2.9					
	3.6		2.4			2.4					
	16.2	0.6		3.4			3.4				
1.3		3.2			3.2						
2.0		2.9			2.9						
2.8		2.5			2.5						
3.6		2.1			2.1						



UNI-PIER LOAD CAPACITY SPECIFICATION

Builder's Grade Uni-Piers (65 x 65 x 2) - FOR WIND CLASSIFICATION N1, N2, N3

Pier Location	Bearer Type	Roof Width	Max. Pier Height	N1 & N2				N3							
				Pier Grid Spacing (m) (MAXIMUM)				Pier Grid Spacing (m) (MAXIMUM)							
				Sheet		Tile		Sheet		Tile					
				No Brace	Brace	No Brace	Brace	No Brace	Brace	No Brace	Brace				
PIER LOCATION 4		9.0	0.6	8.0	8.0	8.0	8.0	8.0	8.0	8.0	8.0	6.3	8.0	6.3	
			1.3	7.3	7.2	7.3	7.2	7.3	7.2	7.3	7.2	7.3	5.6	7.3	5.6
			2.0	6.3	5.9	6.3	5.9	6.3	5.9	6.3	5.9	6.3	4.5	6.3	4.5
			2.8	5.1	4.3	5.1	4.3	5.1	4.3	5.1	4.3	5.1	3.2	5.1	3.2
		3.6	4.1	3.1	4.1	3.1	4.1	3.1	4.1	3.1	4.1	2.2	4.1	2.2	
		12.6	0.6	7.9	7.6	7.9	7.6	7.9	7.6	7.9	7.6	7.9	5.9	7.9	5.9
			1.3	7.2	6.8	7.2	6.8	7.2	6.8	7.2	6.8	7.2	5.2	7.2	5.2
			2.0	6.2	5.5	6.2	5.5	6.2	5.5	6.2	5.5	6.2	4.1	6.2	4.1
			2.8	5.0	4.0	5.0	4.0	5.0	4.0	5.0	4.0	5.0	2.9	5.0	2.9
	3.6	4.0	2.9	4.0	2.9	4.0	2.9	4.0	2.9	4.0	2.1	4.0	2.1		
	16.2	0.6	7.8	7.4	7.8	7.4	7.8	7.4	7.8	7.4	7.8	5.7	7.8	5.7	
		1.3	7.1	6.6	7.1	6.6	7.1	6.6	7.1	6.6	7.1	5.0	7.1	5.0	
2.0		6.1	5.3	6.1	5.3	6.1	5.3	6.1	5.3	6.1	4.0	6.1	4.0		
2.8		5.0	3.8	5.0	3.8	5.0	3.8	5.0	3.8	5.0	2.8	5.0	2.8		
3.6	4.0	2.8	4.0	2.8	4.0	2.8	4.0	2.8	4.0	2.0	4.0	2.0			
PIER LOCATION 4		9.0	0.6	6.0	5.4	6.0	5.4	6.0	5.4	6.0	4.1	6.0	4.1		
			1.3	5.6	4.9	5.6	4.9	5.6	4.9	5.6	4.9	5.6	3.7	5.6	3.7
			2.0	5.0	4.2	5.0	4.2	5.0	4.2	5.0	4.2	5.0	3.1	5.0	3.1
			2.8	4.2	3.2	4.2	3.2	4.2	3.2	4.2	3.2	4.2	2.3	4.2	2.3
		3.6	3.6	2.5	3.6	2.5	3.6	2.5	3.6	2.5	3.6	1.7	3.6	1.7	
		12.6	0.6	5.9	5.1	5.9	5.1	5.9	5.1	5.9	5.1	5.9	3.8	5.9	3.8
			1.3	5.5	4.6	5.5	4.6	5.5	4.6	5.5	4.6	5.5	3.4	5.5	3.4
			2.0	5.0	3.9	5.0	3.9	5.0	3.9	5.0	3.9	5.0	2.8	5.0	2.8
			2.8	4.1	3.0	4.1	3.0	4.1	3.0	4.1	3.0	4.1	2.1	4.1	2.1
	3.6	3.4	2.3	3.4	2.3	3.4	2.3	3.4	2.3	3.4	1.6	3.4	1.6		
	16.2	0.6	5.8	4.9	5.8	4.9	5.8	4.9	5.8	4.9	5.8	3.6	5.8	3.6	
		1.3	5.4	4.4	5.4	4.4	5.4	4.4	5.4	4.4	5.4	3.2	5.4	3.2	
2.0		4.9	3.7	4.9	3.7	4.9	3.7	4.9	3.7	4.9	2.7	4.9	2.7		
2.8		4.1	2.9	4.1	2.9	4.1	2.9	4.1	2.9	4.1	2.0	4.1	2.0		
3.6	3.4	2.2	3.4	2.2	3.4	2.2	3.4	2.2	3.4	1.5	3.4	1.5			
PIER LOCATION 5		9.0	0.6	7.0	6.3	6.2	5.5	7.0	5.1	6.2	4.5	7.0	4.5		
			1.3	6.4	5.6	5.7	4.9	6.5	4.4	5.6	4.0	6.5	4.4	5.6	4.0
			2.0	5.4	4.5	4.7	3.9	5.3	3.5	4.5	3.1	5.3	3.5	4.5	3.1
			2.8	4.2	3.2	3.6	2.7	3.9	2.5	3.3	2.2	3.9	2.5	3.3	2.2
		3.6	3.3	2.3	2.7	1.9	2.9	1.7	2.3	1.5	2.9	1.7	2.3	1.5	
		12.6	0.6	6.6	5.7	5.6	4.8	6.4	4.5	5.3	4.0	6.4	4.5	5.3	4.0
			1.3	6.0	5.1	5.1	4.2	5.7	4.0	4.7	3.4	5.7	4.0	4.7	3.4
			2.0	5.0	4.0	4.1	3.3	4.6	3.1	3.7	2.7	4.6	3.1	3.7	2.7
			2.8	3.9	2.9	3.1	2.3	3.3	2.2	2.6	1.8	3.3	2.2	2.6	1.8
	3.6	3.0	2.0	2.2	1.6	2.4	1.5	1.9	1.3	2.4	1.5	1.9	1.3		
	16.2	0.6	6.1	5.2	5.1	4.3	5.7	4.1	4.6	3.5	5.7	4.1	4.6	3.5	
		1.3	5.6	4.6	4.6	3.7	5.0	3.6	4.0	3.0	5.0	3.6	4.0	3.0	
2.0		4.6	3.7	3.6	2.9	4.0	2.8	3.1	2.3	4.0	2.8	3.1	2.3		
2.8		3.5	2.6	2.6	2.0	2.9	2.0	2.2	1.6	2.9	2.0	2.2	1.6		
3.6	2.5	1.8	1.8	1.4	2.0	1.3	1.5	1.1	2.0	1.3	1.5	1.1			
PIER LOCATION 5		9.0	0.6	5.1	4.1	4.4	3.5	4.9	3.2	4.0	2.8	4.9	3.2	4.0	2.8
			1.3	4.7	3.7	4.0	3.2	4.5	2.9	3.7	2.5	4.5	2.9	3.7	2.5
			2.0	4.2	3.1	3.5	2.7	3.8	2.4	3.2	2.1	3.8	2.4	3.2	2.1
			2.8	3.4	2.4	2.8	2.0	3.0	1.8	2.4	1.6	3.0	1.8	2.4	1.6
		3.6	2.8	1.8	2.2	1.5	2.3	1.4	1.8	1.2	2.3	1.4	1.8	1.2	
		12.6	0.6	4.7	3.7	3.9	3.0	4.2	2.9	3.4	2.4	4.2	2.9	3.4	2.4
			1.3	4.3	3.3	3.5	2.7	3.8	2.5	3.1	2.2	3.8	2.5	3.1	2.2
			2.0	3.8	2.8	3.0	2.3	3.2	2.1	2.6	1.8	3.2	2.1	2.6	1.8
			2.8	3.0	2.1	2.3	1.7	2.5	1.6	2.0	1.4	2.5	1.6	2.0	1.4
	3.6	2.3	1.6	1.7	1.3	1.9	1.2	1.5	1.0	1.9	1.2	1.5	1.0		
	16.2	0.6	4.4	3.3	3.3	2.7	3.6	2.6	2.9	2.1	3.6	2.6	2.9	2.1	
		1.3	4.0	3.0	3.0	2.4	3.3	2.3	2.6	1.9	3.3	2.3	2.6	1.9	
2.0		3.4	2.5	2.5	2.0	2.7	1.9	2.2	1.6	2.7	1.9	2.2	1.6		
2.8		2.6	1.9	1.9	1.5	2.1	1.4	1.6	1.1	2.1	1.4	1.6	1.1		
3.6	2.0	1.4	1.4	1.1	1.6	1.0	1.2	0.9	1.6	1.0	1.2	0.9			

USING THIS SPECIFICATION

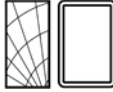
Uni-Piers are to be set in a square grid pattern, except for the verandah. To obtain your maximum pier centres, follow the steps below.

1. Choose the pier condition in question from the pier plan below.
2. Using the number indicated by the pier condition, refer to the corresponding table set on the left.
3. Determine whether the job has *timber* or *closed steel* section bearers:
 - 
 - or C-section steel bearers: 
4. Select a *roof width* in metres
5. Choose your *maximum pier height* in metres
6. Finally, determine if the job has a sheet or tile roof, with or without bracing.
7. All brickwork is to be supported on concrete footings only.
8. Capacity tables are based on assumption that piers are spaced the same in both directions. (ie X=Y in Pier Location Diagram)

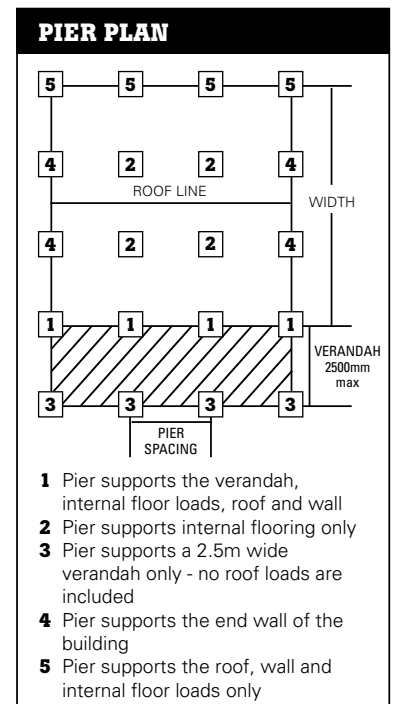

UNI-PIER LOAD CAPACITY SPECIFICATION

Heavy Grade Uni-Piers (75 x 75 x 2.5) - FOR WIND CLASSIFICATION N1, N2, N3

USING THIS SPECIFICATION

Uni-Piers are to be set in a square grid pattern, except for the verandah. To obtain your maximum pier centres, follow the steps below.

- Choose the pier condition in question from the pier plan below.
- Using the number indicated by the pier condition, refer to the corresponding table set on the right.
- Determine whether the job has *timber* or *closed steel* section bearers:

or C-section steel bearers:
- Select a *roof* width in metres
- Choose your *maximum pier height* in metres
- Finally, determine if the job has a sheet or tile roof, with or without bracing.
- All brickwork is to be supported on concrete footings only.
- Capacity tables are based on assumption that piers are spaced the same in both directions. (ie X=Y in Pier Location Diagram)

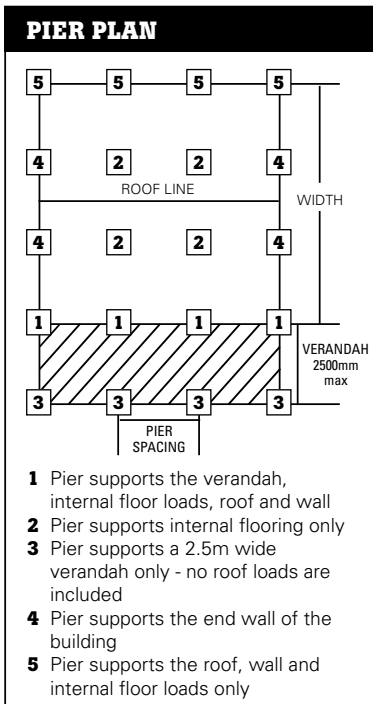

Pier Location	Bearer Type	Roof Width	Max. Pier Height	N1 & N2				N3			
				Pier Grid Spacing (m) (MAXIMUM)				Pier Grid Spacing (m) (MAXIMUM)			
				Sheet		Tile		Sheet		Tile	
				No Brace	Brace	No Brace	Brace	No Brace	Brace	No Brace	Brace
1		9.0	0.6	7.3	7.3	6.7	6.7	7.3	6.9	6.7	6.2
			1.3	6.8	6.8	6.2	6.2	6.8	6.3	6.2	5.7
			2.0	5.9	5.9	5.3	5.2	5.9	5.2	5.3	4.7
		2.8	4.7	4.5	4.2	4.0	4.7	4.0	4.2	3.5	
		3.6	3.5	3.2	3.0	2.8	3.5	2.8	3.0	1.5	
		3.6	3.0	2.8	2.8	2.4	3.3	2.5	2.8	2.2	
		9.0	0.6	4.9	4.8	4.4	4.2	5.0	4.2	4.4	3.8
			1.3	4.6	4.4	4.1	3.9	4.6	3.9	4.1	3.5
			2.0	4.1	3.9	3.7	3.4	4.2	3.4	3.7	3.0
		2.8	3.4	3.1	3.0	2.7	3.4	2.7	3.0	2.4	
		3.6	2.7	2.3	2.3	2.0	2.7	2.0	2.3	1.8	
		3.6	2.7	2.3	2.3	2.0	2.7	2.0	2.3	1.8	
2		N/A	0.6	7.2	7.1	7.2	7.1	7.2	7.0	7.2	7.0
			1.3	6.8	6.7	6.8	6.7	6.8	6.6	6.8	6.6
			2.0	6.1	6.0	6.1	6.0	6.1	5.9	6.1	5.9
			2.8	5.1	5.0	5.1	5.0	5.1	4.9	5.1	4.9
			3.6	4.1	4.0	4.1	4.0	4.1	3.8	4.1	3.8
			3.6	4.1	4.0	4.1	4.0	4.1	3.8	4.1	3.8
		N/A	0.6	5.3	5.2	5.3	5.2	5.3	5.1	5.3	5.1
			1.3	5.1	5.0	5.1	5.0	5.1	4.8	5.1	4.8
			2.0	4.7	4.6	4.7	4.6	4.7	4.4	4.7	4.4
			2.8	4.0	4.0	4.0	4.0	4.0	3.7	4.0	3.7
			3.6	3.4	3.3	3.4	3.3	3.4	3.0	3.4	3.0
			3.6	3.4	3.3	3.4	3.3	3.4	3.0	3.4	3.0
3		2.5	0.6	5.1	4.9	5.1	4.9	5.1	4.9	5.1	4.9
			1.3	4.8	4.6	4.8	4.6	4.8	4.6	4.8	4.6
			2.0	4.4	4.1	4.4	4.1	4.4	4.1	4.4	4.1
			2.8	3.7	3.5	3.7	3.5	3.7	3.5	3.7	3.5
			3.6	3.1	2.9	3.1	2.9	3.1	2.9	3.1	2.9
			3.6	3.1	2.9	3.1	2.9	3.1	2.9	3.1	2.9
		2.5	0.6	3.9	3.7	3.9	3.7	3.9	3.7	3.9	3.7
			1.3	3.7	3.5	3.7	3.5	3.7	3.5	3.7	3.5
			2.0	3.4	3.2	3.4	3.2	3.4	3.2	3.4	3.2
			2.8	3.0	2.8	3.0	2.8	3.0	2.8	3.0	2.8
			3.6	2.6	2.5	2.6	2.5	2.6	2.5	2.6	2.5
			3.6	2.6	2.5	2.6	2.5	2.6	2.5	2.6	2.5
	N/A	0.6	5.5	5.5	5.5	5.5	5.5	5.5	5.5	5.5	
		1.3	5.2	5.2	5.2	5.2	5.2	5.2	5.2	5.2	
		2.0	4.7	4.7	4.7	4.7	4.7	4.7	4.7	4.7	
		2.8	4.0	4.0	4.0	4.0	4.0	4.0	4.0	4.0	
		3.6	3.3	3.3	3.3	3.3	3.3	3.3	3.3	3.3	
		3.6	3.3	3.3	3.3	3.3	3.3	3.3	3.3	3.3	
	N/A	0.6	4.2	4.2	4.2	4.2	4.2	4.2	4.2	4.2	
		1.3	4.0	4.0	4.0	4.0	4.0	4.0	4.0	4.0	
		2.0	3.7	3.7	3.7	3.7	3.7	3.7	3.7	3.7	
		2.8	3.2	3.2	3.2	3.2	3.2	3.2	3.2	3.2	
		3.6	2.8	2.8	2.8	2.8	2.8	2.8	2.8	2.8	
		3.6	2.8	2.8	2.8	2.8	2.8	2.8	2.8	2.8	

UNI-PIER LOAD CAPACITY SPECIFICATION

Heavy Grade Uni-Piers (75 x 75 x 2.5) - FOR WIND CLASSIFICATION N1, N2, N3

Pier Location	Bearer Type	Roof Width	Max. Pier Height	N1 & N2				N3			
				Pier Grid Spacing (m) (MAXIMUM)				Pier Grid Spacing (m) (MAXIMUM)			
				Sheet		Tile		Sheet		Tile	
				No Brace	Brace	No Brace	Brace	No Brace	Brace	No Brace	Brace
4		9.0	0.6	10.0	10.0	10.0	10.0	10.0	8.9	10.0	8.9
			1.3	9.4	9.4	9.4	9.4	9.4	8.2	9.4	8.2
			2.0	8.4	8.4	8.4	8.4	8.4	6.9	8.4	6.9
			2.8	7.1	6.9	7.1	6.9	7.1	5.4	7.1	5.4
		3.6	5.8	5.2	5.8	5.2	5.8	3.9	5.8	3.9	
		12.6	0.6	9.9	9.9	9.9	9.9	9.9	8.4	9.9	8.4
			1.3	9.3	9.3	9.3	9.3	9.3	7.7	9.3	7.7
			2.0	8.3	8.3	8.3	8.3	8.3	6.5	8.3	6.5
			2.8	7.0	6.5	7.0	6.5	7.0	5.0	7.0	5.0
		3.6	5.7	4.8	5.7	4.8	5.7	3.6	5.7	3.6	
		16.2	0.6	9.8	9.8	9.8	9.8	9.8	8.1	9.8	8.1
			1.3	9.2	9.2	9.2	9.2	9.2	7.4	9.2	7.4
	2.0		8.2	8.0	8.2	8.0	8.2	6.2	8.2	6.2	
	2.8		6.9	6.3	6.9	6.3	6.9	4.8	6.9	4.8	
	3.6	5.6	4.6	5.6	4.6	5.6	3.4	5.6	3.4		
		9.0	0.6	7.4	7.3	7.4	7.3	7.4	5.7	7.4	5.7
			1.3	7.0	6.8	7.0	6.8	7.0	5.2	7.0	5.2
			2.0	6.5	6.1	6.5	6.1	6.5	4.7	6.5	4.7
			2.8	5.6	5.0	5.6	5.0	5.6	3.7	5.6	3.7
		3.6	4.7	3.9	4.7	3.9	4.7	2.9	4.7	2.9	
		12.6	0.6	7.3	6.9	7.3	6.9	7.3	5.3	7.3	5.3
			1.3	6.9	6.4	6.9	6.4	6.9	4.9	6.9	4.9
			2.0	6.4	5.7	6.4	5.7	6.4	4.3	6.4	4.3
			2.8	5.6	4.7	5.6	4.7	5.6	3.4	5.6	3.4
3.6		4.7	3.7	4.7	3.7	4.7	2.6	4.7	2.6		
16.2		0.6	7.2	6.6	7.2	6.6	7.2	5.1	7.2	5.1	
		1.3	6.8	6.2	6.8	6.2	6.8	4.7	6.8	4.7	
	2.0	6.3	5.5	6.3	5.5	6.3	4.1	6.3	4.1		
	2.8	5.5	4.5	5.5	4.5	5.5	3.5	5.5	3.3		
3.6	4.6	3.5	4.6	3.5	4.6	2.5	4.6	2.5			
5		9.0	0.6	9.0	8.7	8.2	7.8	9.0	7.2	8.2	6.5
			1.3	8.4	8.0	7.7	7.2	8.5	6.6	7.7	6.0
			2.0	7.5	6.9	6.7	6.1	7.5	5.6	6.9	5.0
			2.8	6.2	5.4	5.5	4.7	6.2	4.2	5.4	3.8
		3.6	4.9	4.0	4.3	3.4	4.7	3.0	4.0	2.7	
		12.6	0.6	8.6	8.1	7.5	7.0	8.6	6.6	7.5	5.8
			1.3	8.0	7.4	7.0	6.4	8.0	6.0	7.0	5.3
			2.0	7.0	6.3	6.1	5.3	7.0	5.0	5.9	4.4
			2.8	5.8	4.9	4.9	4.1	5.5	3.8	4.5	3.3
		3.6	4.5	3.5	3.7	2.9	4.0	2.7	3.3	2.3	
		16.2	0.6	8.1	7.5	7.0	6.2	8.0	6.1	6.6	5.2
			1.3	7.6	6.8	6.4	5.7	7.3	5.5	6.0	4.7
	2.0		6.6	5.8	5.5	4.7	6.2	4.6	5.1	3.8	
	2.8		5.4	4.4	4.4	3.6	4.8	3.4	3.8	2.9	
	3.6	4.2	3.2	3.2	2.5	3.5	2.4	2.7	2.0		
		9.0	0.6	6.4	5.7	5.7	5.0	6.4	4.5	5.7	4.0
			1.3	6.1	5.2	5.4	4.6	6.0	4.1	5.3	3.7
			2.0	5.6	4.7	4.9	4.0	5.5	3.6	4.7	3.2
			2.8	4.8	3.8	4.1	3.2	4.5	2.9	3.8	2.6
		3.6	4.0	3.0	3.3	2.5	3.6	2.2	3.0	2.0	
		12.6	0.6	6.0	5.1	5.1	4.3	5.8	4.0	4.8	3.5
			1.3	5.7	4.8	4.8	4.0	5.4	3.7	4.4	3.2
			2.0	5.2	4.2	4.3	3.5	4.8	3.3	3.9	2.8
			2.8	4.4	3.4	3.6	2.8	3.9	2.6	3.1	2.2
3.6		3.6	2.6	2.8	2.1	3.0	2.0	2.4	1.7		
16.2		0.6	5.7	4.7	4.6	3.8	5.1	3.7	4.1	3.1	
		1.3	5.3	4.3	4.3	3.5	4.7	3.4	3.7	2.8	
	2.0	4.8	3.8	3.8	3.0	4.2	3.0	3.3	2.5		
	2.8	4.0	3.0	3.1	2.4	3.4	2.3	2.6	1.9		
3.6	3.3	2.3	2.3	1.8	2.6	1.8	2.0	1.4			

USING THIS SPECIFICATION

Uni-Piers are to be set in a square grid pattern, except for the verandah. To obtain your maximum pier centres, follow the steps below.

1. Choose the pier condition in question from the pier plan below.
2. Using the number indicated by the pier condition, refer to the corresponding table set on the left.
3. Determine whether the job has *timber* or *closed steel* section bearers:
 -
- or C-section steel bearers:
 -
4. Select a *roof width* in metres
5. Choose your *maximum pier height* in metres
6. Finally, determine if the job has a sheet or tile roof, with or without bracing.
7. All brickwork is to be supported on concrete footings only.
8. Capacity tables are based on assumption that piers are spaced the same in both directions. (ie X=Y in Pier Location Diagram)

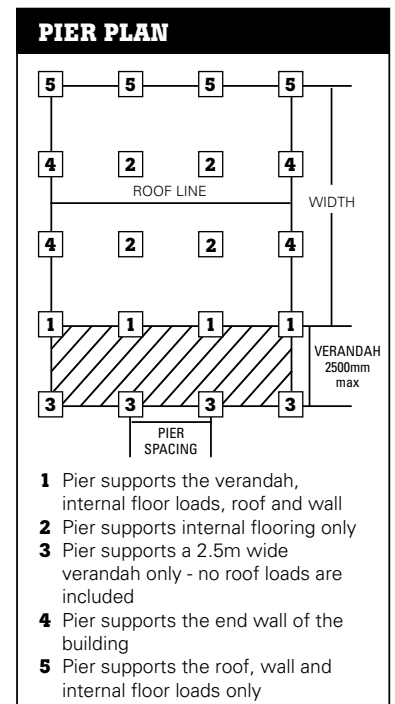

UNI-PIER LOAD CAPACITY SPECIFICATION

Builder's Grade Uni-Piers (65 x 65 x 2) - FOR WIND CLASSIFICATION C1, C2, N4, N5

USING THIS SPECIFICATION

Uni-Piers are to be set in a square grid pattern, except for the verandah. To obtain your maximum pier centres, follow the steps below.

1. Choose the pier condition in question from the pier plan below.
2. Using the number indicated by the pier condition, refer to the corresponding table set on the right.

3. Determine whether the job has *timber* or *closed steel* section bearers:

or C-section steel bearers:



4. Select a *roof* width in metres
5. Choose your *maximum pier height* in metres
6. Finally, determine if the job has a sheet or tile roof, with or without bracing.
7. All brickwork is to be supported on concrete footings only.
8. Capacity tables are based on assumption that piers are spaced the same in both directions. (ie X=Y in Pier Location Diagram)

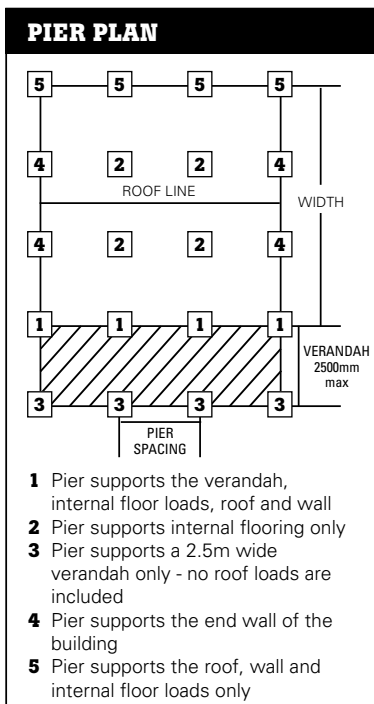

Pier Location	Bearer Type	Roof Width	Max. Pier Height	N4 & C1				N5 & C2			
				Pier Grid Spacing (m) (MAXIMUM)				Pier Grid Spacing (m) (MAXIMUM)			
				Sheet		Tile		Sheet		Tile	
				No Brace	Brace	No Brace	Brace	No Brace	Brace	No Brace	Brace
1		9.0	0.6	5.4	3.7	4.9	3.4	4.9	2.9	4.4	2.7
			1.3	4.9	3.2	4.3	2.9	4.3	2.5	3.8	2.3
			2.0	4.0	2.5	3.6	2.2	3.4	1.9	3.0	1.8
		2.8	2.9	1.7	2.5	1.5	2.3	1.3	2.1	1.2	
		3.6	2.0	1.2	1.7	1.0	1.6	0.9	1.4	0.8	
		12.6	0.6	4.5	3.0	4.3	3.0	4.1	2.6	3.6	2.3
	1.3		3.9	2.6	3.8	2.6	3.6	2.2	3.1	2.0	
	2.0		3.1	2.0	3.0	2.0	2.8	1.7	2.4	1.5	
	2.8	2.1	1.4	2.0	1.3	1.9	1.2	1.6	1.0		
	3.6	1.4	0.9	1.4	0.9	1.3	0.8	1.1	0.7		
	16.2	0.6	4.4	3.0	3.7	2.6	3.5	2.3	3.0	2.0	
		1.3	3.9	2.6	3.2	2.3	3.0	2.0	2.6	1.8	
2.0		3.0	2.0	2.5	1.7	2.3	1.5	2.0	1.3		
2.8	2.1	1.3	1.7	1.2	1.6	1.0	1.3	0.9			
3.6	1.4	0.9	1.1	0.7	1.1	0.7	0.9	0.5			
2		9.0	0.6	3.8	2.2	3.3	2.0	3.1	1.7	2.7	1.6
			1.3	3.4	2.0	2.9	1.8	2.7	1.5	2.4	1.4
			2.0	2.8	1.6	2.4	1.5	2.3	1.3	2.0	1.2
		2.8	2.1	1.2	1.8	1.1	1.7	0.9	1.5	0.8	
		3.6	1.6	0.9	1.3	0.8	1.2	0.7	1.1	0.5	
		12.6	0.6	2.8	1.8	2.7	1.8	2.5	1.5	2.2	1.4
	1.3		2.5	1.6	2.4	1.6	2.2	1.4	1.9	1.2	
	2.0		2.0	1.3	2.0	1.3	1.9	1.1	1.6	1.0	
	2.8	1.5	1.0	1.4	1.0	1.4	0.8	1.2	0.7		
	3.6	1.1	0.7	1.1	0.7	1.0	0.5	0.8	0.5		
	16.2	0.6	2.7	1.8	2.2	1.6	2.1	1.3	1.8	1.2	
		1.3	2.4	1.6	2.0	1.4	1.9	1.2	1.6	1.1	
2.0		2.0	1.3	1.6	1.1	1.5	1.0	1.3	0.9		
2.8	1.5	1.0	1.2	0.8	1.1	0.7	0.9	0.5			
3.6	1.1	0.7	0.9	0.6	0.8	0.5	0.7	0.3			
3		N/A	0.6	5.9	5.7	5.9	5.7	5.9	5.6	5.9	5.6
			1.3	5.5	5.3	5.5	5.3	5.5	5.2	5.5	5.2
			2.0	4.8	4.6	4.8	4.6	4.8	4.4	4.8	4.4
		2.8	4.0	3.6	4.0	3.6	4.0	3.5	4.0	3.5	
		3.6	3.2	2.9	3.2	2.9	3.2	2.7	3.2	2.7	
		2.5	0.6	4.1	3.9	4.1	3.9	4.1	3.9	4.1	3.9
	1.3		3.8	3.6	3.8	3.6	3.8	3.6	3.8	3.6	
	2.0		3.3	3.2	3.3	3.2	3.3	3.2	3.3	3.2	
	2.8	2.7	2.6	2.7	2.6	2.7	2.6	2.7	2.6		
	3.6	2.2	2.1	2.2	2.1	2.2	2.1	2.2	2.1		
	2.5	0.6	3.2	3.0	3.2	3.0	3.2	3.0	3.2	3.0	
		1.3	2.9	2.8	2.9	2.8	2.9	2.8	2.9	2.8	
2.0		2.7	2.5	2.7	2.5	2.7	2.5	2.7	2.5		
2.8	2.2	2.2	2.2	2.2	2.2	2.2	2.2	2.2			
3.6	1.9	1.9	1.9	1.9	1.9	1.9	1.9	1.9			
	N/A	0.6	4.4	4.4	4.4	4.4	4.4	4.4	4.4		
		1.3	4.1	4.1	4.1	4.1	4.1	4.1	4.1		
		2.0	3.6	3.6	3.6	3.6	3.6	3.6	3.6		
	2.8	2.9	2.9	2.9	2.9	2.9	2.9	2.9			
	3.6	2.4	2.4	2.4	2.4	2.4	2.4	2.4			
	N/A	0.6	3.4	3.4	3.4	3.4	3.4	3.4	3.4		
1.3		3.2	3.2	3.2	3.2	3.2	3.2	3.2			
2.0		2.9	2.9	2.9	2.9	2.9	2.9	2.9			
2.8	2.5	2.5	2.5	2.5	2.5	2.5	2.5				
3.6	2.1	2.1	2.1	2.1	2.1	2.1	2.1				

UNI-PIER LOAD CAPACITY SPECIFICATION

Builder's Grade Uni-Piers (65 x 65 x 2) - FOR WIND CLASSIFICATION C1, C2, N4, N5

Pier Location	Bearer Type	Roof Width	Max. Pier Height	N4 & C1				N5 & C2			
				Pier Grid Spacing (m) (MAXIMUM)				Pier Grid Spacing (m) (MAXIMUM)			
				Sheet		Tile		Sheet		Tile	
				No Brace	Brace	No Brace	Brace	No Brace	Brace	No Brace	Brace
PIER LOCATION 4		9.0	0.6	8.0	5.6	8.0	5.6	8.0	4.5	8.0	4.5
			1.3	7.3	4.9	7.3	4.9	7.3	3.9	7.3	3.9
			2.0	6.3	3.9	6.3	3.9	6.3	3.0	6.3	3.0
			2.8	5.1	2.7	5.1	2.7	5.1	2.1	5.1	2.1
		3.6	4.1	1.9	4.1	1.9	4.1	1.4	4.1	1.4	
		12.6	0.6	7.9	5.2	7.9	5.2	7.9	4.1	7.9	4.1
			1.3	7.2	4.6	7.2	4.6	7.2	3.6	7.2	3.6
			2.0	6.2	3.6	6.2	3.6	6.2	2.8	6.2	2.8
			2.8	5.0	2.5	5.0	2.5	5.0	1.9	5.0	1.9
		3.6	4.0	1.7	4.0	1.7	4.0	1.3	4.0	1.3	
		16.2	0.6	7.8	4.9	7.8	4.9	7.8	3.9	7.8	3.9
			1.3	7.1	4.3	7.1	4.3	7.1	3.4	7.1	3.4
2.0	6.1		3.4	6.1	3.4	6.1	2.6	6.1	2.6		
2.8	5.0		2.3	5.0	2.3	5.0	1.8	5.0	1.8		
3.6	4.0	1.6	4.0	1.6	4.0	1.2	4.0	1.2			
PIER LOCATION 4		9.0	0.6	6.0	3.6	6.0	3.6	6.0	2.8	6.0	2.8
			1.3	5.6	3.2	5.6	3.2	5.6	2.5	5.6	2.5
			2.0	5.0	2.6	5.0	2.6	5.0	2.0	5.0	2.0
			2.8	4.2	2.0	4.2	2.0	4.2	1.5	4.2	1.5
		3.6	3.6	1.5	3.6	1.5	3.6	1.1	3.6	1.1	
		12.6	0.6	5.9	3.2	5.9	3.2	5.9	2.5	5.9	2.5
			1.3	5.5	2.9	5.5	2.9	5.5	2.2	5.5	2.2
			2.0	5.0	2.4	5.0	2.4	5.0	1.8	5.0	1.8
			2.8	4.1	1.8	4.1	1.8	4.1	1.4	4.1	1.4
		3.6	3.4	1.4	3.4	1.4	3.4	1.0	3.4	1.0	
		16.2	0.6	5.8	3.1	5.8	3.1	5.8	2.3	5.8	2.3
			1.3	5.4	2.7	5.4	2.7	5.4	2.1	5.4	2.1
2.0	4.9		2.3	4.9	2.3	4.9	1.7	4.9	1.7		
2.8	4.1		1.7	4.1	1.7	4.1	1.3	4.1	1.3		
3.6	3.4	1.2	3.4	1.2	3.4	0.9	3.4	0.9			
PIER LOCATION 5		9.0	0.6	6.4	4.0	5.6	3.6	5.3	3.5	4.7	3.2
			1.3	5.7	3.4	5.0	3.1	4.6	3.0	4.1	2.8
			2.0	4.6	2.7	4.0	2.4	3.7	2.3	3.2	2.1
			2.8	3.3	1.8	2.8	1.7	2.6	1.6	2.3	1.4
		3.6	2.4	1.3	2.0	1.1	1.8	1.1	1.6	1.0	
		12.6	0.6	5.5	3.5	4.6	3.1	4.4	3.1	3.8	2.8
			1.3	4.9	3.1	4.1	2.7	3.9	2.7	3.3	2.4
			2.0	3.8	2.4	3.2	2.1	3.0	2.1	2.6	1.9
			2.8	2.7	1.6	2.2	1.4	2.1	1.4	1.8	1.3
		3.6	1.9	1.1	1.6	1.0	1.4	1.0	1.2	0.9	
		16.2	0.6	4.7	3.2	3.9	2.7	3.7	2.8	3.1	2.5
			1.3	4.1	2.8	3.4	2.4	3.2	2.5	2.7	2.1
2.0	3.3		2.1	2.6	1.8	2.5	1.9	2.1	1.6		
2.8	2.3		1.4	1.8	1.2	1.7	1.3	1.4	1.1		
3.6	1.6	1.0	1.3	0.8	1.2	0.9	1.0	0.8			
PIER LOCATION 5		9.0	0.6	4.3	2.5	3.7	2.2	3.4	2.1	3.0	1.9
			1.3	3.9	2.2	3.3	2.0	3.0	1.9	2.7	1.7
			2.0	3.3	1.8	2.8	1.6	2.5	1.5	2.2	1.4
			2.8	2.5	1.4	2.1	1.2	1.9	1.1	1.6	1.0
		3.6	1.9	1.0	1.6	0.9	1.4	0.8	1.2	0.7	
		12.6	0.6	3.6	2.2	2.9	1.9	2.8	1.9	2.3	1.7
			1.3	3.2	1.9	2.6	1.7	2.4	1.7	2.1	1.5
			2.0	2.7	1.6	2.2	1.4	2.0	1.4	1.7	1.2
			2.8	2.0	1.2	1.6	1.0	1.5	1.0	1.3	0.9
		3.6	1.5	0.9	1.2	0.8	1.1	0.7	0.9	0.5	
		16.2	0.6	3.0	1.9	2.4	1.7	2.3	1.7	1.9	1.5
			1.3	2.7	1.7	2.2	1.5	2.0	1.5	1.7	1.3
2.0	2.2		1.4	1.8	1.2	1.7	1.2	1.4	1.1		
2.8	1.7		1.0	1.3	0.9	1.2	0.9	1.0	0.8		
3.6	1.2	0.8	1.0	0.7	0.9	0.7	0.7	0.5			

USING THIS SPECIFICATION

Uni-Piers are to be set in a square grid pattern, except for the verandah. To obtain your maximum pier centres, follow the steps below.

1. Choose the pier condition in question from the pier plan below.
2. Using the number indicated by the pier condition, refer to the corresponding table set on the left.
3. Determine whether the job has *timber* or *closed steel* section bearers:
 -
 - or C-section steel bearers:
4. Select a *roof width* in metres
5. Choose your *maximum pier height* in metres
6. Finally, determine if the job has a sheet or tile roof, with or without bracing.
7. All brickwork is to be supported on concrete footings only.
8. Capacity tables are based on assumption that piers are spaced the same in both directions. (ie X=Y in Pier Location Diagram)

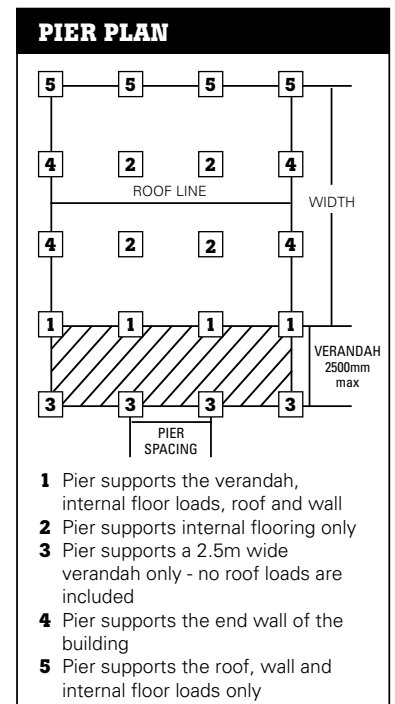

UNI-PIER LOAD CAPACITY SPECIFICATION

Heavy Grade Uni-Piers (75 x 75 x 2.5) - FOR WIND CLASSIFICATION C1, C2, N4, N5

USING THIS SPECIFICATION

Uni-Piers are to be set in a square grid pattern, except for the verandah. To obtain your maximum pier centres, follow the steps below.

1. Choose the pier condition in question from the pier plan below.
2. Using the number indicated by the pier condition, refer to the corresponding table set on the right.

3. Determine whether the job has *timber* or *closed steel* section bearers:

or C-section steel bearers:





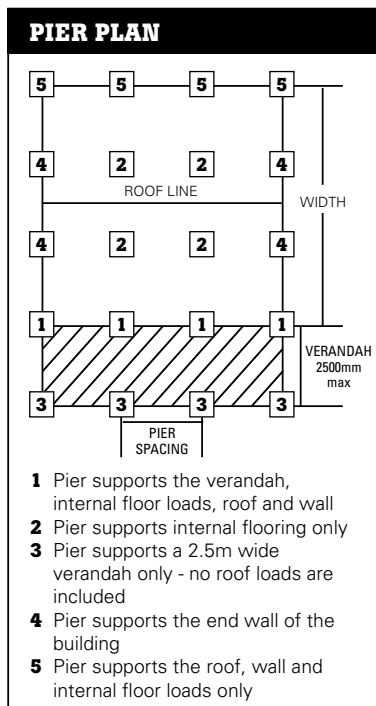

4. Select a *roof* width in metres
5. Choose your *maximum pier height* in metres
6. Finally, determine if the job has a sheet or tile roof, with or without bracing.
7. All brickwork is to be supported on concrete footings only.
8. Capacity tables are based on assumption that piers are spaced the same in both directions. (ie X=Y in Pier Location Diagram)



Pier Location	Bearer Type	Roof Width	Max. Pier Height	N4 & C1				N5 & C2				
				Pier Grid Spacing (m) (MAXIMUM)				Pier Grid Spacing (m) (MAXIMUM)				
				Sheet		Tile		Sheet		Tile		
				No Brace	Brace	No Brace	Brace	No Brace	Brace	No Brace	Brace	
1		9.0	0.6	7.3	5.5	6.7	5.1	7.2	4.4	6.5	4.1	
			1.3	6.8	5.0	6.2	4.6	6.5	4.0	5.9	3.7	
			2.0	5.9	4.1	5.3	3.8	5.5	3.2	4.9	3.0	
			2.8	4.7	3.1	4.2	2.8	4.1	2.4	3.7	2.2	
		3.6	3.5	2.1	3.0	1.9	2.9	1.6	2.6	1.5		
		12.6	0.6	6.6	4.6	6.2	4.5	6.1	4.0	5.4	3.6	
	1.3		6.0	4.1	5.7	4.0	5.5	3.5	4.8	3.2		
	2.0		5.0	3.4	4.8	3.3	4.6	2.9	4.0	2.6		
	2.8		3.7	2.5	3.6	2.4	3.4	2.1	3.0	1.9		
	3.6	2.6	1.7	2.5	1.7	2.4	1.5	2.1	1.3			
	16.2	0.6	6.5	4.5	5.5	4.0	5.2	3.5	4.5	3.2		
		1.3	5.9	4.1	4.9	3.6	4.7	3.1	4.1	2.8		
2.0		4.9	3.3	4.1	2.9	3.9	2.5	3.3	2.3			
2.8		3.7	2.5	3.0	2.1	2.9	1.9	2.5	1.7			
3.6	2.6	1.7	2.1	1.5	2.0	1.3	1.7	1.1				
1		9.0	0.6	4.9	3.3	4.6	3.0	4.4	2.5	3.9	2.3	
			1.3	4.6	3.0	4.3	2.7	4.0	2.3	3.6	2.1	
			2.0	4.1	2.6	3.7	2.4	3.5	2.0	3.1	1.9	
			2.8	3.4	2.0	3.0	1.8	2.8	1.6	2.5	1.4	
		3.6	2.7	1.5	2.3	1.4	2.1	1.2	1.9	1.1		
		12.6	0.6	4.0	2.7	3.8	2.6	3.7	2.3	3.2	2.0	
	1.3		3.7	2.4	3.5	2.4	3.3	2.1	2.9	1.9		
	2.0		3.2	2.1	3.1	2.1	2.9	1.8	2.5	1.6		
	2.8		2.5	1.6	2.4	1.6	2.3	1.4	2.0	1.2		
	3.6	1.9	1.2	1.8	1.2	1.7	1.0	1.5	0.9			
	16.2	0.6	3.9	2.6	3.2	2.3	3.1	2.0	2.7	1.8		
		1.3	3.6	2.4	3.0	2.1	2.8	1.8	2.4	1.6		
2.0		3.1	2.1	2.6	1.8	2.4	1.6	2.1	1.4			
2.8		2.5	1.6	2.0	1.4	1.9	1.2	1.6	1.1			
3.6	1.9	1.2	1.5	1.1	1.4	0.9	1.2	0.8				
2		N/A	0.6	7.2	6.8	7.2	6.8	7.2	6.6	7.2	6.6	
			1.3	6.8	6.4	6.8	6.4	6.8	6.1	6.8	6.1	
			2.0	6.1	5.6	6.1	5.6	6.1	5.3	6.1	5.3	
			2.8	5.1	4.6	5.1	4.6	5.1	4.2	5.1	4.2	
		3.6	4.1	3.5	4.1	3.5	4.1	2.9	4.1	2.9		
		N/A	0.6	5.3	4.8	5.3	4.8	5.3	4.4	5.3	4.4	
	1.3		5.1	4.5	5.1	4.5	5.1	4.1	5.1	4.1		
	2.0		4.7	4.1	4.7	4.1	4.7	3.6	4.7	3.6		
	2.8		4.0	3.3	4.0	3.3	4.0	2.8	4.0	2.8		
	3.6	3.4	2.5	3.4	2.5	3.4	1.7	3.4	1.7			
	2		N/A	0.6	5.3	4.8	5.3	4.8	5.3	4.4	5.3	4.4
				1.3	5.1	4.5	5.1	4.5	5.1	4.1	5.1	4.1
2.0				4.7	4.1	4.7	4.1	4.7	3.6	4.7	3.6	
2.8				4.0	3.3	4.0	3.3	4.0	2.8	4.0	2.8	
3.6			3.4	2.5	3.4	2.5	3.4	1.7	3.4	1.7		
N/A			0.6	5.3	4.8	5.3	4.8	5.3	4.4	5.3	4.4	
		1.3	5.1	4.5	5.1	4.5	5.1	4.1	5.1	4.1		
		2.0	4.7	4.1	4.7	4.1	4.7	3.6	4.7	3.6		
		2.8	4.0	3.3	4.0	3.3	4.0	2.8	4.0	2.8		
3.6		3.4	2.5	3.4	2.5	3.4	1.7	3.4	1.7			
3			2.5	0.6	5.1	4.9	5.1	4.9	5.1	4.9	5.1	4.9
				1.3	4.8	4.6	4.8	4.6	4.8	4.6	4.8	4.6
	2.0			4.4	4.1	4.4	4.1	4.4	4.1	4.4	4.1	
	2.8			3.7	3.5	3.7	3.5	3.7	3.5	3.7	3.5	
	3.6		3.1	2.9	3.1	2.9	3.1	2.9	3.1	2.9		
	2.5		0.6	3.9	3.7	3.9	3.7	3.9	3.7	3.9	3.7	
		1.3	3.7	3.5	3.7	3.5	3.7	3.5	3.7	3.5		
		2.0	3.4	3.2	3.4	3.2	3.4	3.2	3.4	3.2		
		2.8	3.0	2.8	3.0	2.8	3.0	2.8	3.0	2.8		
	3.6	2.6	2.5	2.6	2.5	2.6	2.5	2.6	2.5			
	3		N/A	0.6	5.5	5.5	5.5	5.5	5.5	5.5	5.5	
				1.3	5.2	5.2	5.2	5.2	5.2	5.2	5.2	
2.0				4.7	4.7	4.7	4.7	4.7	4.7	4.7		
2.8				4.0	4.0	4.0	4.0	4.0	4.0	4.0		
3.6		3.3	3.3	3.3	3.3	3.3	3.3	3.3				
		N/A	0.6	4.2	4.2	4.2	4.2	4.2	4.2	4.2		
	1.3		4.0	4.0	4.0	4.0	4.0	4.0	4.0			
	2.0		3.7	3.7	3.7	3.7	3.7	3.7	3.7			
	2.8		3.2	3.2	3.2	3.2	3.2	3.2	3.2			
3.6	2.8	2.8	2.8	2.8	2.8	2.8	2.8					



UNI-PIER LOAD CAPACITY SPECIFICATION

Heavy Grade Uni-Piers (75 x 75 x 2.5) - FOR WIND CLASSIFICATION C1, C2, N4, N5

Pier Location	Bearer Type	Roof Width	Max. Pier Height	N4 & C1				N5 & C2			
				Pier Grid Spacing (m) (MAXIMUM)				Pier Grid Spacing (m) (MAXIMUM)			
				Sheet		Tile		Sheet		Tile	
				No Brace	Brace	No Brace	Brace	No Brace	Brace	No Brace	Brace
PIER LOCATION 4		9.0	0.6	10.0	8.0	10.0	8.0	10.0	6.6	10.0	6.6
			1.3	9.4	7.3	9.4	7.3	9.4	5.8	9.4	5.8
			2.0	8.4	6.1	8.4	6.1	8.4	4.9	8.4	4.9
			2.8	7.1	4.7	7.1	4.7	7.1	3.7	7.1	3.7
		3.6	5.8	3.3	5.8	3.3	5.8	2.6	5.8	2.6	
		12.6	0.6	9.9	7.5	9.9	7.5	9.9	6.1	9.9	6.1
			1.3	9.3	6.7	9.3	6.7	9.3	5.5	9.3	5.5
			2.0	8.3	5.7	8.3	5.7	8.3	4.5	8.3	4.5
			2.8	7.0	4.3	7.0	4.3	7.0	3.4	7.0	3.4
		3.6	5.7	3.1	5.7	3.1	5.7	2.4	5.7	2.4	
		16.2	0.6	9.8	7.1	9.8	7.1	9.8	5.7	9.8	5.7
			1.3	9.2	6.5	9.2	6.5	9.2	5.2	9.2	5.2
	2.0		8.2	5.4	8.2	5.4	8.2	4.3	8.2	4.3	
	2.8		6.9	4.1	6.9	4.1	6.9	3.2	6.9	3.2	
	3.6	5.6	2.9	5.6	2.9	5.6	2.2	5.6	2.2		
		9.0	0.6	7.4	5.0	7.4	5.0	7.4	4.0	7.4	4.0
			1.3	7.0	4.6	7.0	4.6	7.0	3.6	7.0	3.6
			2.0	6.5	4.0	6.5	4.0	6.5	3.2	6.5	3.2
			2.8	5.6	3.2	5.6	3.2	5.6	2.5	5.6	2.5
		3.6	4.7	2.4	4.7	2.4	4.7	1.9	4.7	1.9	
		12.6	0.6	7.3	4.6	7.3	4.6	7.3	3.6	7.3	3.6
			1.3	6.9	4.2	6.9	4.2	6.9	3.3	6.9	3.3
			2.0	6.4	3.7	6.4	3.7	6.4	2.9	6.4	2.9
			2.8	5.6	2.9	5.6	2.9	5.6	2.3	5.6	2.3
3.6		4.7	2.1	4.7	2.1	4.7	1.7	4.7	1.7		
16.2		0.6	7.2	4.3	7.2	4.3	7.2	3.4	7.2	3.4	
		1.3	6.8	4.0	6.8	4.0	6.8	3.1	6.8	3.1	
	2.0	6.3	3.5	6.3	3.5	6.3	2.7	6.3	2.7		
	2.8	5.5	2.8	5.5	2.8	5.5	2.1	5.5	2.1		
3.6	4.6	2.1	4.6	2.1	4.6	1.6	4.6	1.6			
PIER LOCATION 5		9.0	0.6	8.9	5.8	8.0	5.3	7.5	5.2	6.8	4.8
			1.3	8.2	5.3	7.3	4.8	6.9	4.7	6.2	4.3
			2.0	7.0	4.4	6.2	4.0	5.8	3.8	5.2	3.5
			2.8	5.5	3.3	4.8	3.0	4.5	2.9	4.0	2.6
		3.6	4.0	2.3	3.4	2.1	3.2	2.0	2.8	1.8	
		12.6	0.6	7.8	5.2	6.7	4.7	6.4	4.7	5.6	4.2
			1.3	7.1	4.7	6.1	4.2	5.8	4.2	5.1	3.8
			2.0	6.0	3.9	5.1	3.5	4.9	3.5	4.2	3.1
			2.8	4.6	2.9	3.9	2.6	3.7	2.6	3.2	2.3
		3.6	3.3	2.0	2.8	1.8	2.6	1.8	2.2	1.6	
		16.2	0.6	6.8	4.7	5.7	4.1	5.5	4.3	4.7	3.8
			1.3	6.2	4.3	5.2	3.7	5.0	3.9	4.3	3.4
	2.0		5.2	3.5	4.3	3.1	4.1	3.2	3.5	2.8	
	2.8		4.0	2.6	3.2	2.3	3.1	2.3	2.6	2.0	
	3.6	2.8	1.8	2.3	1.6	2.1	1.6	1.8	1.4		
		9.0	0.6	5.8	3.5	5.1	3.2	4.7	3.1	4.2	2.8
			1.3	5.4	3.2	4.7	2.9	4.4	2.8	3.8	2.6
			2.0	4.8	2.8	4.2	2.6	3.9	2.4	3.4	2.2
			2.8	3.9	2.2	3.4	2.0	3.1	1.9	2.7	1.7
		3.6	3.1	1.7	2.6	1.5	2.4	1.4	2.0	1.3	
		12.6	0.6	5.0	3.1	4.2	2.8	3.9	2.8	3.4	2.5
			1.3	4.6	2.9	3.8	2.5	3.6	2.5	3.1	2.3
			2.0	4.1	2.5	3.4	2.2	3.2	2.2	2.7	2.0
			2.8	3.3	2.0	2.7	1.7	2.5	1.7	2.1	1.5
3.6		2.5	1.5	2.1	1.3	1.9	1.3	1.6	1.1		
16.2		0.6	4.2	2.8	3.5	2.4	3.3	2.5	2.8	2.2	
		1.3	3.9	2.6	3.2	2.2	3.0	2.3	2.5	2.0	
	2.0	3.4	2.2	2.8	1.9	2.6	2.0	2.2	1.7		
	2.8	2.7	1.8	2.2	1.5	2.1	1.5	1.7	1.3		
3.6	2.1	1.3	1.7	1.1	1.5	1.2	1.3	1.0			

USING THIS SPECIFICATION

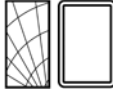
Uni-Piers are to be set in a square grid pattern, except for the verandah. To obtain your maximum pier centres, follow the steps below.

1. Choose the pier condition in question from the pier plan below.
2. Using the number indicated by the pier condition, refer to the corresponding table set on the left.
3. Determine whether the job has *timber* or *closed steel* section bearers:
 - 
 - or C-section steel bearers: 
4. Select a *roof width* in metres
5. Choose your *maximum pier height* in metres
6. Finally, determine if the job has a sheet or tile roof, with or without bracing.
7. All brickwork is to be supported on concrete footings only.
8. Capacity tables are based on assumption that piers are spaced the same in both directions. (ie X=Y in Pier Location Diagram)

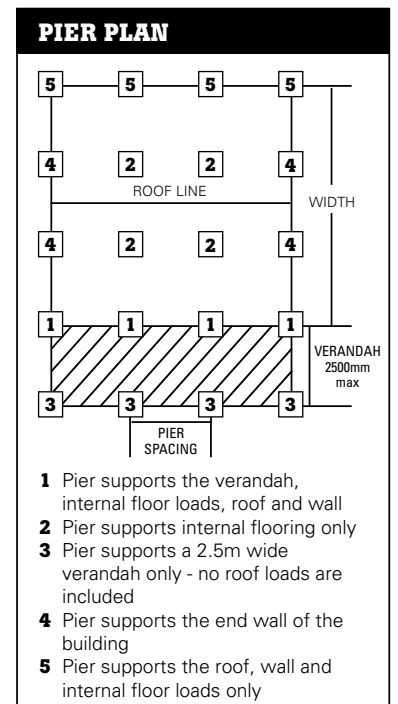

Connection details

for Builder's Grade and Heavy Grade Uni-Piers

Head to post connections. See diagrams on page 15

S = Screws B = Bolts	Roof width (m)	Grid Spacings (max)	Number of fasteners Wind region N1 & N2						Number of fasteners Wind region N3				Number of fasteners Wind region N4 & C1				Number of fasteners Wind region N5 & C2			
			Sheet			Tile			Sheet		Tile		Sheet		Tile		Sheet		Tile	
			No brace		Brace	No brace		Brace	No brace	Brace	No brace	Brace	No brace	Brace	No brace	Brace	No brace	Brace	No brace	Brace
			S	B	S	B	S	B	S	B	S	B	S	B	S	B	S	B	S	B
PIER LOCATION 1	9	1.5x1.5	4	2	4	2	6	2	6	2	4	2	6	2	4	2	6	2	10	2
		2.5x2.5	8	2	8	2	8	2	8	2	10	2	8	2	10	2	8	2	18	4
		3.5x3.5	10	2	10	2	12	3	12	3	10	2	14	3	16	3	10	2	18	4
		4.5x4.5	14	3	14	3	16	3	16	3	14	3	18	4	16	3	14	3	18	4
		5.5x5.5	18	4	18	4	-	4	-	4	-	18	4	-	4	-	20	4	20	5
	12.6	1.5x1.5	4	2	6	2	6	2	6	2	4	2	6	2	8	2	6	2	10	2
		2.5x2.5	8	2	8	2	10	2	10	2	8	2	10	2	12	3	12	3	18	4
		3.5x3.5	12	3	12	3	14	3	14	3	12	3	14	3	18	4	16	3	18	4
		4.5x4.5	16	3	16	3	18	4	18	4	16	3	20	4	18	4	16	3	20	4
		5.5x5.5	20	4	20	4	-	6	-	6	-	20	4	-	6	-	20	4	20	5
	16.2	1.5x1.5	6	2	6	2	6	2	8	2	6	2	8	2	8	2	10	2	14	3
		2.5x2.5	8	2	10	2	10	2	12	3	8	2	12	3	10	2	14	3	18	4
		3.5x3.5	12	3	12	3	16	3	16	3	12	3	16	3	20	4	14	3	18	4
		4.5x4.5	16	4	16	4	20	4	20	4	16	4	20	4	20	4	16	4	20	4
		5.5x5.5	-	4	-	4	6	6	6	6	-	4	-	5	-	6	-	6	-	6
PIER LOCATION 2	NA	1.5x1.5	4	2	4	2	4	2	4	2	4	2	4	2	4	2	4	2	6	2
		2.5x2.5	4	2	4	2	4	2	4	2	4	2	4	2	6	2	4	2	8	2
		3.5x3.5	8	2	8	2	8	2	8	2	8	2	8	2	8	2	8	2	10	2
		4.5x4.5	12	2	12	2	12	2	12	2	12	2	12	2	12	2	12	2	12	2
		5.5x5.5	16	2	16	2	16	2	16	2	16	2	16	2	16	2	16	2	16	2
PIER LOCATION 3	NA	1.5x1.5	2	2	2	2	2	2	2	2	2	2	2	2	2	2	2	2	2	2
		2.5x2.5	4	2	4	2	4	2	4	2	4	2	4	2	4	2	4	2	4	2
		3.5x3.5	4	2	4	2	4	2	4	2	4	2	4	2	4	2	4	2	4	2
		4.5x4.5	6	2	6	2	6	2	6	2	6	2	6	2	6	2	6	2	6	2
		5.5x5.5	8	2	8	2	8	2	8	2	8	2	8	2	8	2	8	2	8	2
PIER LOCATION 4	NA	1.5x1.5	2	2	4	2	2	2	4	2	2	2	4	2	2	2	6	2	6	2
		2.5x2.5	4	2	6	2	4	2	6	2	4	2	8	2	4	2	10	2	12	2
		3.5x3.5	4	2	8	2	4	2	8	2	4	2	10	2	4	2	12	3	16	3
		4.5x4.5	8	2	10	2	8	2	10	2	8	2	14	3	8	2	14	3	18	4
		5.5x5.5	10	2	12	2	10	2	12	2	10	2	18	3	10	2	18	3	20	4
PIER LOCATION 5	9	1.5x1.5	4	2	4	2	4	2	6	2	4	2	6	2	4	2	6	2	10	2
		2.5x2.5	4	2	6	2	6	2	8	2	4	2	6	2	10	2	4	2	14	3
		3.5x3.5	6	2	10	2	8	2	12	2	6	2	12	2	14	3	6	2	18	4
		4.5x4.5	10	2	12	3	12	3	14	3	10	2	16	3	12	3	18	4	20	4
		5.5x5.5	12	3	16	3	16	3	18	4	12	3	20	4	16	3	20	4	20	5
	12.6	1.5x1.5	4	2	4	2	4	2	6	2	4	2	6	2	8	2	4	2	10	2
		2.5x2.5	6	2	8	2	8	2	10	2	6	2	10	2	12	2	6	2	16	3
		3.5x3.5	8	2	10	2	10	2	12	3	8	2	14	3	16	3	8	2	18	4
		4.5x4.5	10	2	14	3	14	3	16	4	10	2	18	4	16	3	14	3	20	4
		5.5x5.5	14	3	18	4	18	3	-	4	14	3	20	4	18	4	16	3	20	4
	16.2	1.5x1.5	4	2	6	2	6	2	6	2	4	2	6	2	8	2	4	2	12	2
		2.5x2.5	6	2	8	2	8	2	10	2	4	2	10	2	14	3	6	2	18	4
		3.5x3.5	8	2	12	3	12	3	14	3	6	2	16	3	14	3	8	2	20	4
		4.5x4.5	12	3	16	3	16	3	20	4	8	2	20	4	18	4	16	3	20	4
		5.5x5.5	16	3	20	4	20	4	-	5	16	3	20	4	18	4	16	3	20	4

Head to post fasteners

Screws: Self Drilling, Self Tapping Screws
14-20 x 22 to AS 3566 Class 4
Bolts: M12 x 100mm galvanised mild steel.

Fin plate to bearer fasteners

Screws for timber bearers: Type 17, 14-10 x 65 to AS 3566 Class 4
Screws for steel bearers: Self Drilling, Self Tapping Screws,
14-20 x 22 to AS 3566 Class 4
Bolts: M12 galvanised mild steel

For pier locations **1** and **5**, in wind regions N3, N4, N5, C1 and C2 the number of fasteners is specified.

For all other situations use 2 screws or 2 bolts.

Sheet	Roof width (m)	Pier centres (mxm)	Number of fasteners Fin plate to bearer Sheet roof		Number of fasteners Fin plate to bearer Sheet roof		Number of fasteners Fin plate to bearer Sheet roof	
			Wind region N3		Wind region N4 & C1		Wind region N5 & C2	
			Screws	Bolts	Screws	Bolts	Screws	Bolts
PIER LOCATIONS 1 & 5	9	1.5x1.5	2	2	2	2	3	2
		2.5x2.5	2	2	3	2	5	3
		3.5x3.5	2	2	4	2	7	4
		4.5x4.5	3	2	5	3	9	5
		5.5x5.5	3	2	6	3	10	6
	12.6	1.5x1.5	2	2	3	2	4	3
		2.5x2.5	3	2	4	3	7	4
		3.5x3.5	3	2	6	3	9	5
		4.5x4.5	4	2	7	4	12	7
		5.5x5.5	5	3	8	5	14	8
	16.2	1.5x1.5	2	2	3	2	5	3
		2.5x2.5	3	2	5	3	9	5
		3.5x3.5	4	3	7	4	12	7
		4.5x4.5	5	3	9	5	15	8
		5.5x5.5	6	3	11	6	18	10

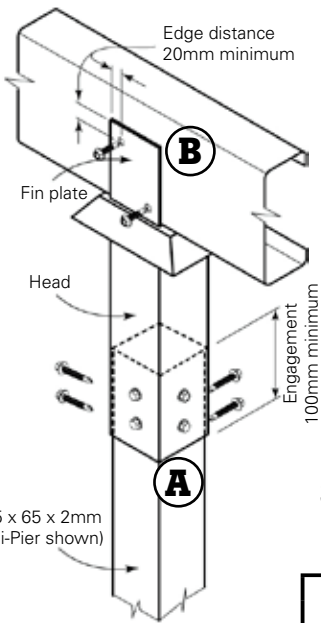

Builders Grade Uni-Pier
(65 x 65 x 2mm post)

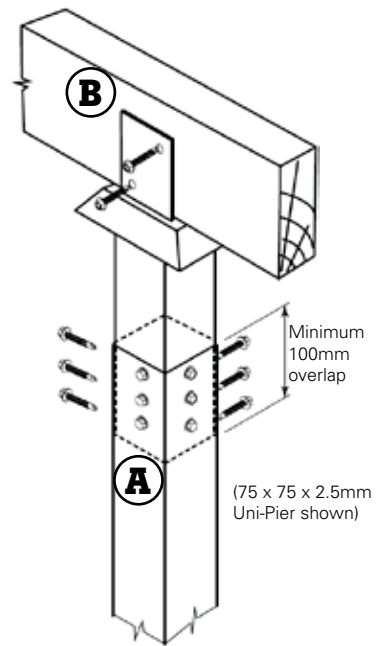

Heavy Grade Uni-Pier
(75 x 75 x 2.5mm post)

Wind regions N1, N2 and N3

Two (M10) galvanised masonry anchors or two 12mm diameter x 125mm anchors.

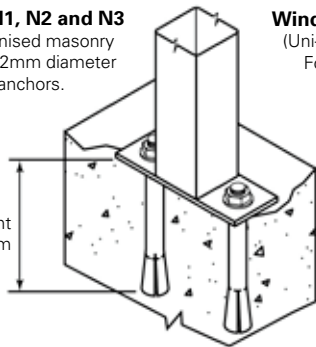

Wind regions N1, N2 and N3

(Uni-Pier to be cast in concrete)
Footing must be designed by a geotechnical or structural engineer

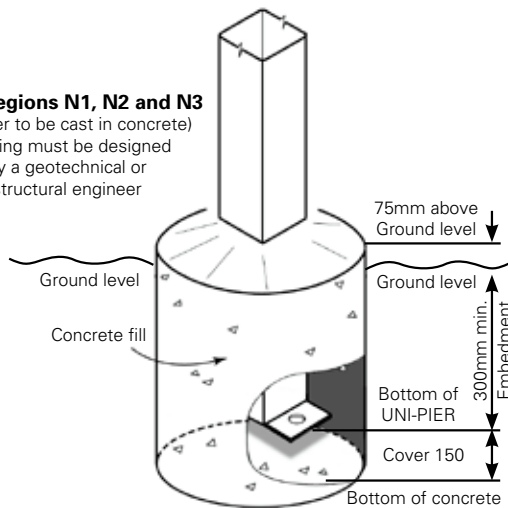

Base Plate to footing connection

Additional Guidelines

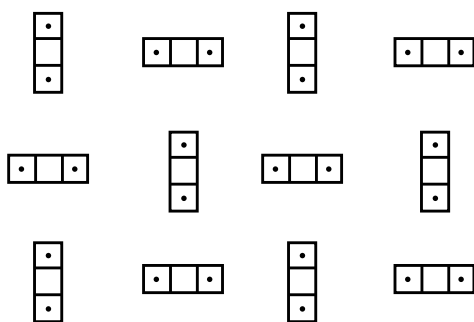

Recommended Pier Orientation

alternate base plate direction for maximum pier stability

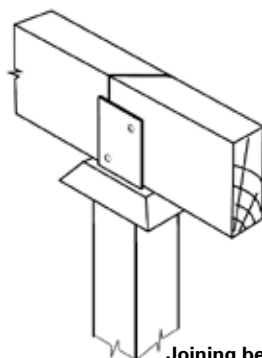

Joining bearers on Pier

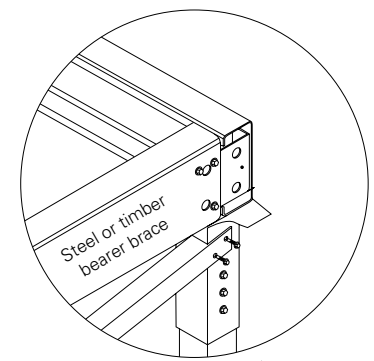

Steel or timber bearer

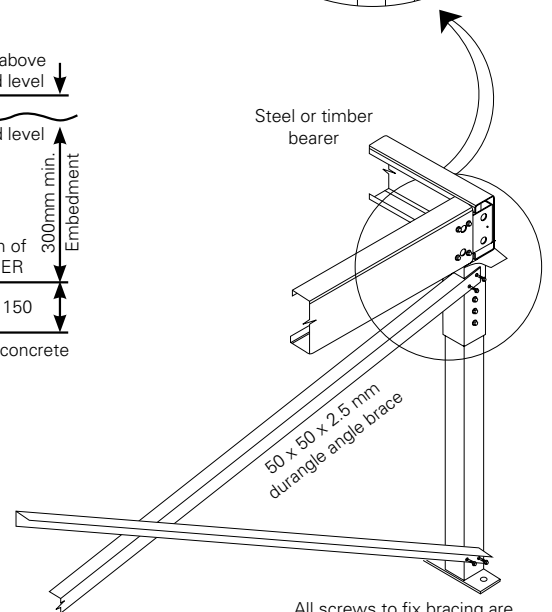

All screws to fix bracing are Self Drilling, Self Tapping Screws 14-20 x 22 to AS 3566 Class 4

Bracing Details

(50 x 50 x 2.5mm Duragal angle)

For information about Uni-Brace refer to Uni-Brace brochure

Design Assumptions

- 1** Data is provided for seven wind regions in five groups according to AS 4055-2006 as follows:

AS4055	Equivalent to:
N1	W28N permissible W34N limit state
N2	W33N permissible W40N limit state
N3	W41N permissible W50N limit state
N4 & C1	W50N & W41C permissible W61N & W50 limit state
N5 & C2	W60N & W50C permissible W74N & W61C limit state

- 2** All brickwork supported on concrete footings.
- 3** Maximum height of wall is 3.0m.
- 4** Height from ground floor level to highest point on roof should not exceed 5.5m.
- 5** **No bracing** implies **masonry veneer** type of construction. **Bracing** implies **cladding** type of construction.
- 6** Allowed Design Loads
 Dead load of floor 0.5 kPa
 Live load of floor 1.5 kPa (for internal areas)
 Live load of floor 3.0 kPa (for external areas eg verandahs)
 Tile and Sheet roofs are considered
 Live load on roof 0.25 kPa
 Allowance made for stud walls lined with plasterboard
- 7** Maximum roof pitch is 35 degrees.
- 8** Capacity tables are based on assumption that piers are spaced the same in both directions. (ie X=Y in Pier Location Diagram).

I hereby certify that the Uni-Pier Selection Guide 2009 including its design tables, bracing details and connection details as well as other information contained therein, has been prepared in accordance with the relevant Australian Standards and the Building Code of Australia. The Uni-Pier Selection Guide can only be applied for the use and installation of actual Uni-Pier products.



Trevor Hall, FIE Aust. CPEng RPEQ 5081
KNEEBONE, BERETTA & HALL PTY. LTD.
 Consulting Engineers

Caution

Uni-piers are generally designed for residential applications, including roof and floor loads.

Where buildings have large "point loads" or where buildings are of an unusual structural design, Uni-Pier Australia Pty Ltd recommend that advice be sought from a registered practising structural engineer.

Construction near salt water and in areas of high salinity will require piers and braces to be protected by a suitable coating.

Site welding of any floor family members is NOT recommended.

All concrete footings to be finished at a sufficient height above ground line so as to prevent any run off water, or soil, coming in contact with steel posts. A height of 75mm is recommended.

If in doubt, always consult a registered practising structural engineer.

This manual was prepared to comply with the relevant Australian Standards and contains technical information for the design for flooring of residential structures and to be applied by a registered practising engineer. Uni-Pier Australia Pty Ltd reserves the right to revise or amend this manual without notice.



FOR MORE INFORMATION CONTACT:
 Uni-Pier Australia Pty Ltd ACN 131 900 546
 1300 366 362
www.unipier.com.au

Copyright. The material in this publication is published by and is the property of Uni-Pier Australia Pty. Ltd. and may not be reproduced in any form without the written permission of the publisher. This product shall perform as specified if used in accordance with the recommendations provided by Uni-Pier Australia Pty. Ltd. Information in this publication is correct at the time of printing but is subject to change without notice.