

Showerline Tile-Over Tray



Installation Guide

Please read instructions carefully before installing; failure to follow instructions voids warranty.

It is the responsibility of the installer of the shower tray to adhere to local building codes in relation to waterproofing and installation.

Importantly, it is the responsibility of the installer to ensure that a water tight seal exists between the tile tray and puddle flange.



www.showerline.com.au

Scan the QR code or visit our website to view video installation guide.

Technical drawings are also available on our website.

- 1 Preparation
- 2 For installation on timber/steel substrate } **IMPORTANT**—Check technical drawing or measure thickness of tray after trimming to ensure correct depth for level entry
For installation on concrete substrate }
- 3 Waste connection (to be connected only by a licensed plumber)
- 4 Trimming
- 5 Laying tray
- 6 Flashing
- 7 Wallboard - Caulking - Priming - Taping
- 8 Waterproofing

For technical support call us on 1800 688 745 or email sales@showerline.com.au.

For technical drawings visit our website www.showerline.com.au

Showerline (Aust) Pty Ltd 5 Kim Ct, North Geelong VIC 3215 ABN: 65 074 117 098

Showerline Tile-Over Tray - Installation Guide

Please read instructions carefully before installing; failure to follow instructions voids warranty.

It is the responsibility of the installer of the shower tray to adhere to local building codes in relation to waterproofing and installation.

Importantly, it is the responsibility of the installer to ensure that a water tight seal exists between the tile tray and puddle flange.



1 Preparation

IMPORTANT - Entire surface of tray **MUST** be thoroughly sanded with 40 grit sandpaper prior to applying adhesives

- Ensure surface is level
- Check condition of substrate
- Re-shape flashing with manipulation if required
- Remove excess dust from all surfaces – methylated spirits will assist adhesion
- Mark and cut out position of base and outlet
- Use adhesives recommended on attached list

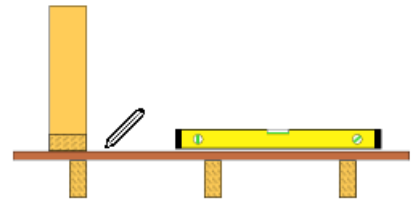

2 For installation on timber/steel substrate

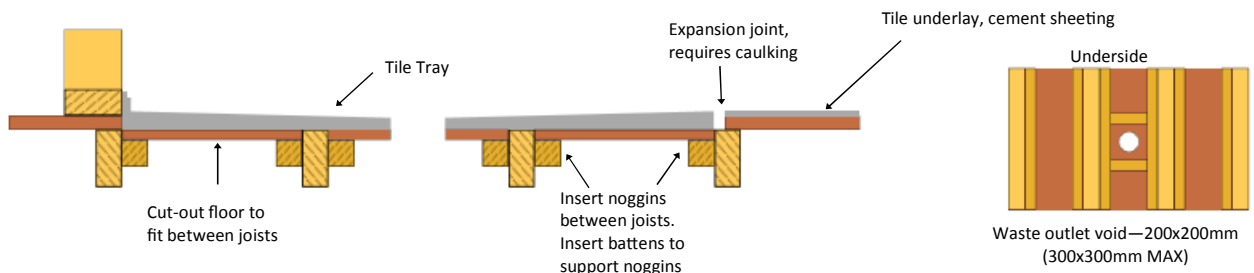

IMPORTANT: FOR LEVEL ENTRY RECESS TRAY AS PER DEPTH SHOWN ON TECHNICAL DRAWING (WWW.SHOWERLINE.COM.AU), OR, MEASURE THICKNESS OF TRAY AFTER TRIMMING

Ensure underside of base is supported by a flat/level surface. Reinforce/strengthen substrate as required.

A minimum 300mm centres is required to support the tile tray. Add trimmers where required.

Note; no requirement to 'check-in' to wall stud due to unique design and flashing.

For installation on concrete substrate

When pouring slab, box out area required to fit appropriate sized tile tray - ensure level surface prior to installing tray

IMPORTANT: CHECK TECHNICAL DRAWING FOR DEPTH REQUIRED, OR, MEASURE THICKNESS OF TRAY AFTER TRIMMING.

3 Waste connection - to be completed only by licensed plumber

Adjustable height 80 x 80 waste outlet kit with chrome grate is supplied with tile tray.

Adjust height to suit tiling by twisting threaded adapter.

IMPORTANT - Use silicon to **ensure** a watertight seal exists between the tile tray and the puddle flange.

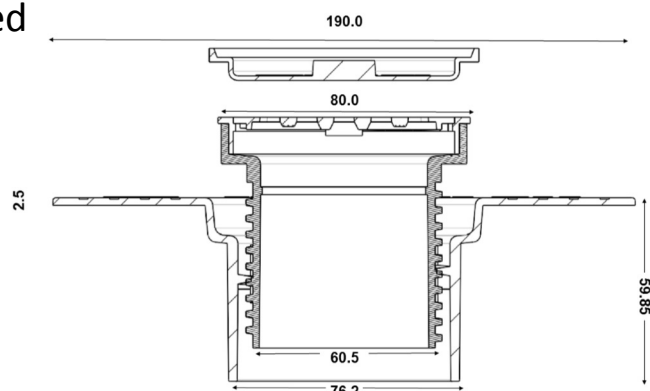

4 Trimming

Tile tray is supplied with 3 or 4 lips to provide more choice for installation positioning.
Use appropriate tool (eg, Stanley knife/Jigsaw) to trim off unrequired sides.
Trimming will not affect performance/durability



5 Laying Tray

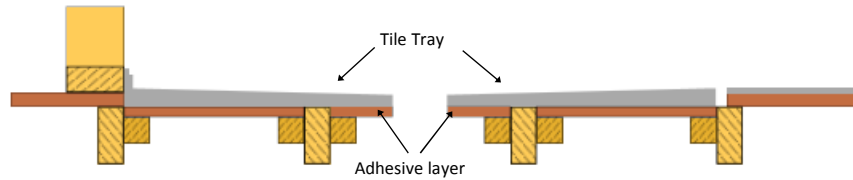

Use the recommended adhesive and apply to substrate as per manufacturers instructions.
Place tray directly over adhesive and lower into position.
Place 4 x 20 kg bags (eg, cement) to ensure adhesion and leave to cure, typically overnight.

6 Flashing

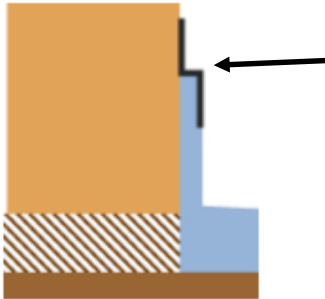

Care must be used when handling flashing to ensure correct fit. Avoid twisting/bending.
Flashing is pre-fitted in factory, however it may require gentle manipulation to achieve proper fit.
Silicon, then place flashing.
Use galvanised clout nails to attach flashing, one per stud. Must be attached to each stud.
Silicon nail heads.



7 Wallboard - Caulking - Priming - Taping

Run a bead of silicon on flashing 'step'. Install waterproof board directly on top of flashing 'step'.
Caulk ALL openings/joins.
Prime surface of tray
Use waterproof tape over the caulked opening between the tile tray and the tile underlay and completely over join between wallboard and tray.

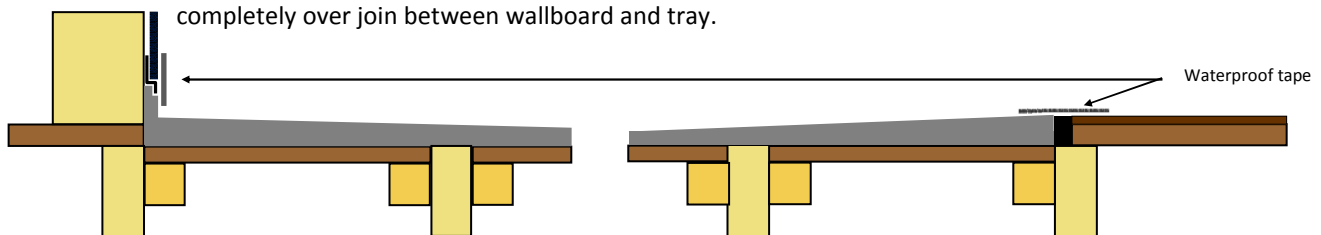

8 Waterproofing

Waterproof all surfaces (walls and tray) to achieve a seamless tank prior to tiling

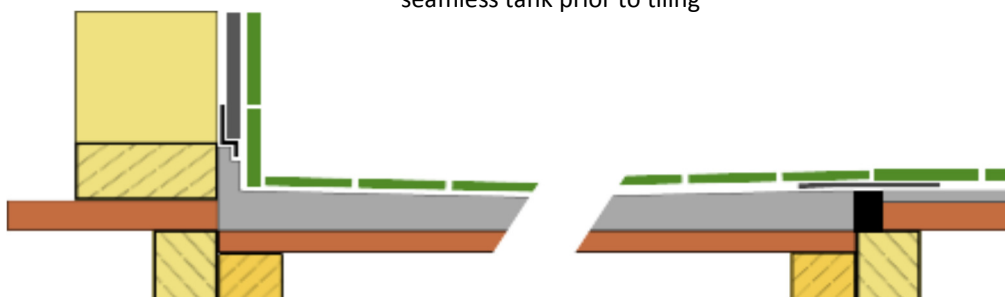

Showerline Tile-Over Tray



The complete shower company

Suggested installation products to use.

These products have been laboratory tested.

IMPORTANT : TRAY MUST BE THOROUGHLY SANDED PRIOR TO APPLYING ANY PRODUCTS TO ENSURE CORRECT ADHESION

For adhering tray to substrate

- Sikaflex – 11FC
- Ardex RA88
- Dunlop Builders Bond
- Selleys Proseries
- Selleys 3 in 1
- Mapeflex PU45

For surface priming

- Aqua Blok moisture seal
- Ardex WPM300 + Broadcast Sand
- Ardex Abapoxy + Broadcast Sand
- Ardex P9 Single Part Primer
- Gripset Betta Prime All
- Dunlop Primer & Additive

For waterproofing

- Betta Rapid Dry Waterproofer Membrane
- Sikalastic-560
- Ardex WPM 155 Rapid Waterproofing

For tile adhesion

- Prohesive Ultrapro (also known as) MCB A100
- Ardex WA100
- Ardex Abaflex X77 +/- E90
- Ardex Abaflex X18 +/- E90
- Ardex STS8 + E90
- Dunlop Tile-All
- Mapei Kerapoxy 410

For expansion joints

- Ardex CA20P
- Mapei Mapeflex PU45

For sealing over expansion joints

- Gripset/Betta peel & seal tape
- Ardex waterproofing detail tape