



10 PCS

HÄFELE

HÄFELE 105° SOFT CLOSE HINGE

Full Overlay - Clip On

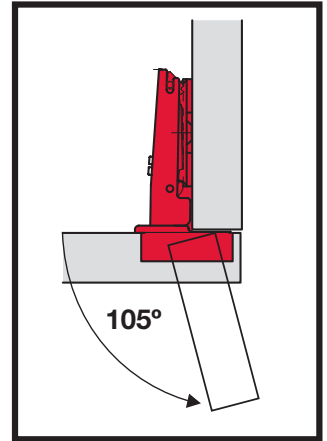

(k)



Adjusting the Door

Depth adjustment of door with Häfele mounting plates.

With the Häfele mounting plates with quick fixing system, a depth adjustment of the door from -0.6 mm up to $+3$ mm is possible via eccentric. It is not necessary to loosen further screws.

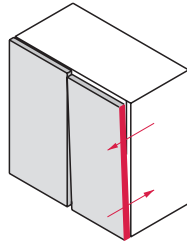
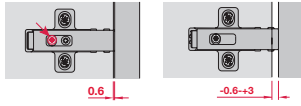

Height adjustment of door with Häfele mounting plates with slot.

Height adjustment of door of ± 2 mm is possible by loosening the two fixing screws. The slots allow the mounting plates to slide in both directions. Afterwards the screws must be re-tightened.

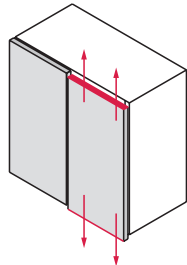
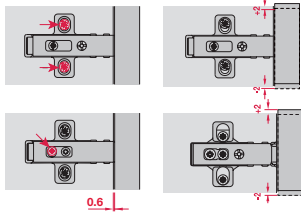

Lateral adjustment of door with Häfele concealed hinges.

The adjusting screw produces the lateral travel of the hinge arm from -2 mm up to $+2$ mm.

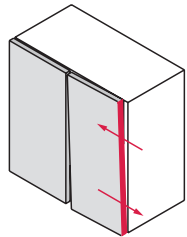
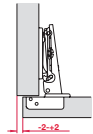

Drilling Instructions

Hinge Cup (Door)

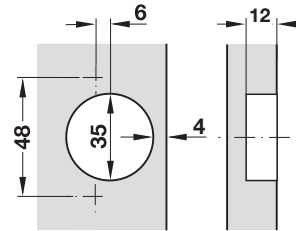

Mount Plate (Cabinet Side)

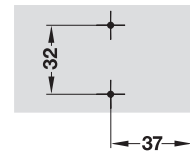
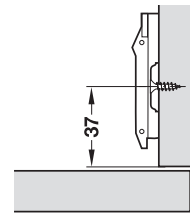

Mounting Instructions

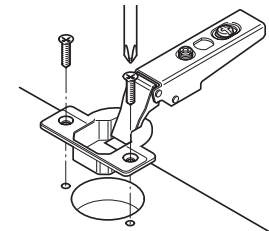

Screw fixing

Cup fixed with screws (countersunk head).

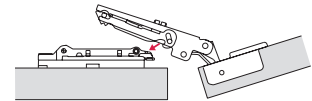

Join the two points marked by an arrow.

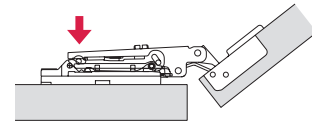

Apply light pressure.

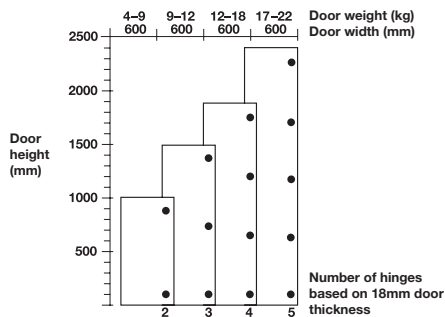

Tools Required:

- > 35mm Ø Drill Bit & Template Kit
- > 2mm Ø Drill Bit
- > Pencil
- > Power Drill
- > No 2 Pozidrive Screwdriver / Screw Bit

MADE IN CHINA

