

ozito

TOUCH-UP SPRAY GUN

160-240ml/min

INSTRUCTION MANUAL

SPECIFICATIONS

Max Air Pressure:	50psi (3.4Bar)
Av. Air Consumption:	56-170l/min (2-6cfm)
Nozzle Size:	Ø1.5mm
Spray Width:	40-70mm
Flow Rate:	160-240ml/min
Feed Type:	Suction
Paint Pot Size:	200ml
Air Inlet:	1/4" BSP
Weight (tool only):	0.4kg

ozito.com.au

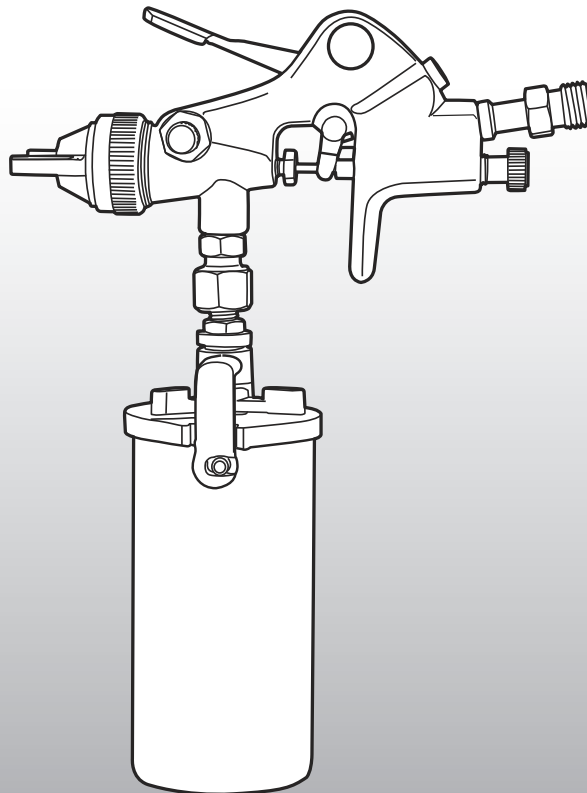

WHAT'S IN THE BOX

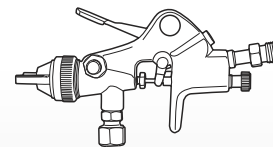

Spray Gun

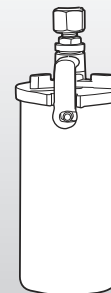

Paint Pot

3 YEAR REPLACEMENT WARRANTY

ASG-PRO

KNOW YOUR PRODUCT

TOUCH UP SPRAY GUN

- | | |
|-----------------------|-------------------------|
| 1 Nozzle | 5 Tightening Collar |
| 2 Nozzle Collar | 6 Variable Trigger |
| 3 Fan Adjustment Dial | 7 Spray Regulation Dial |
| 4 Paint Pot | 8 Air Inlet |

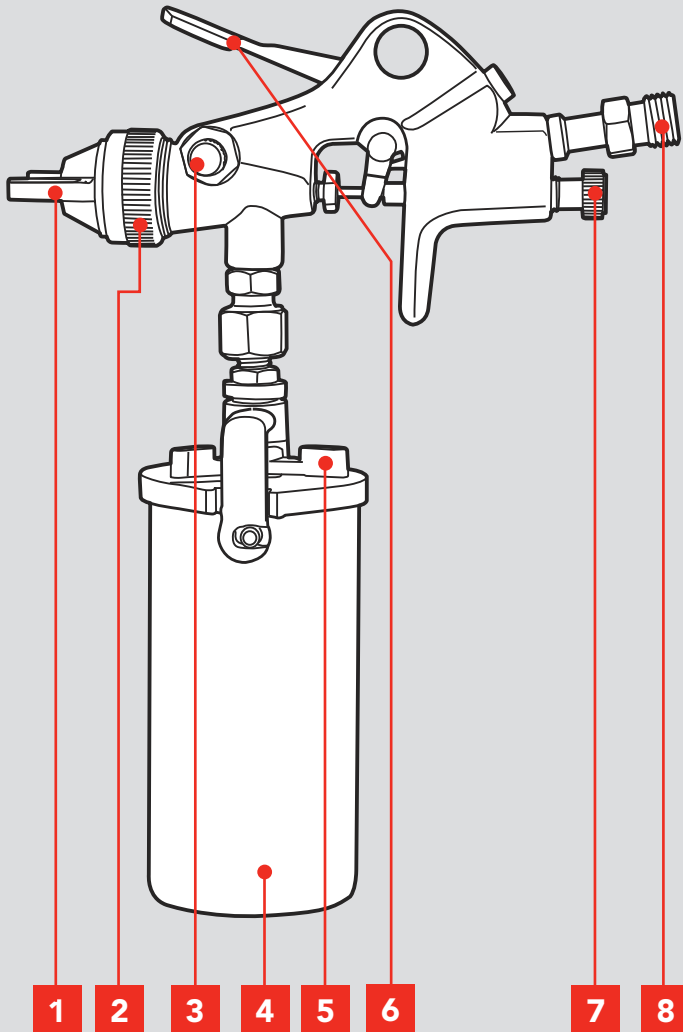

ONLINE MANUAL

Scan this QR Code with your mobile device to take you to the online manual.



SETUP & PREPARATION

1. ASSEMBLY



WARNING! ENSURE THE TOOL IS DISCONNECTED FROM THE AIR SUPPLY BEFORE PERFORMING ANY OF THE FOLLOWING OPERATIONS.

Installing the Paint Pot

- 1 Tightly fasten the joining nut between the paint pot the spray gun head.

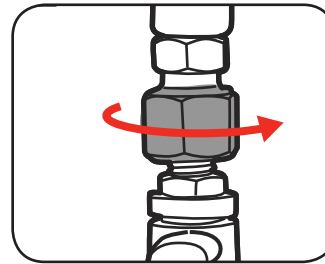

- 2 To remove the paint pot, loosen the tightening collar by turning clockwise. Then twist the pot out of its hooks.

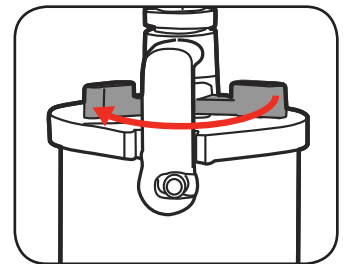

- 3 To secure the paint pot, twist the pot into its hooks. Then fasten the tightening collar by turning anti-clockwise.

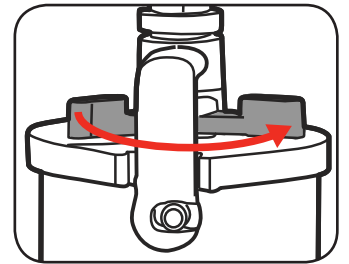

Attaching The Air

- 1 Wrap the threaded male inlet of the spray gun with teflon tape in a clockwise direction.

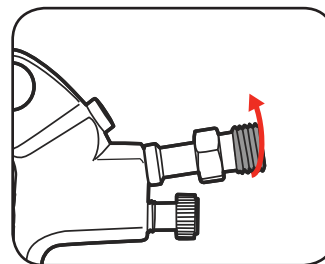

- 2 Screw the female fitting clockwise onto the male end of the air inlet.

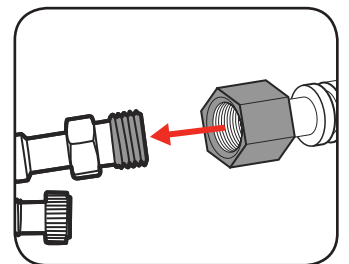

- 3 Pull back the sleeve on hose fitting, insert male end & release sleeve on hose fitting.

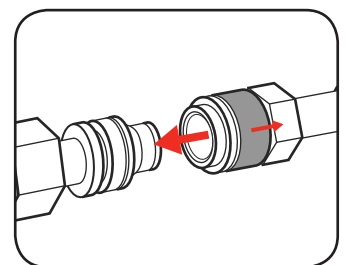

3 YEAR REPLACEMENT WARRANTY

OPERATION

2. PREPARATION

NOTE: FOR BEST RESULTS, SURFACE PREPARATION AND PAINT THINNING ARE THE TWO MOST IMPORTANT AREAS. ENSURE ALL SURFACES ARE FREE OF DUST, DIRT AND GREASE.

Thinning

Thinning is particularly important when spraying. Most paints are supplied ready for brush application and need to be diluted sufficiently for spraying purposes.

Follow the manufacturers guide for thinning ratios which should be labelled on the paint container.

- 1 Before pouring any paint or thinners work out how much of each substance is needed.

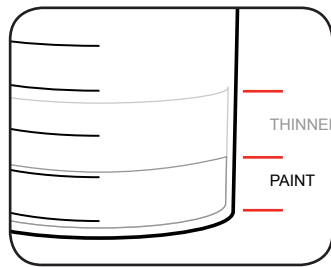

- 2 Pour the required paint and thinners through a filter into a mixing cup and then mix thoroughly.

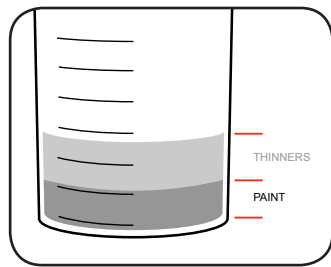

- 3 Once the correct viscosity is obtained, pour the mixture into the paint pot.

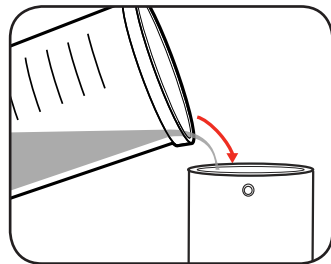

IMPORTANT! THE SPRAY GUN CANNOT BE USED WITH MATERIALS CONTAINING ABRASIVE SUBSTANCES, GLAZES, CAUSTIC AND ALKALINE SUBSTANCES.

Paint Pot Vent Hole

The paint pot has a vent hole to allow air to escape which enables fluid to flow into the spray gun.

Ensure it is clean and not blocked at all times.

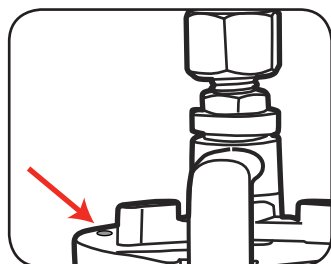

3. ADJUSTING THE SPRAY GUN

Variable Trigger

- 1 Press the variable trigger to allow fluid to be sprayed.

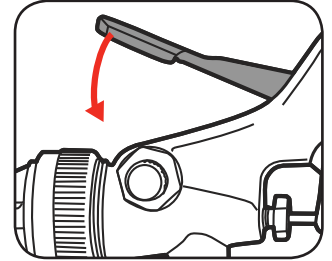

- 2 Release the variable trigger to stop spraying.

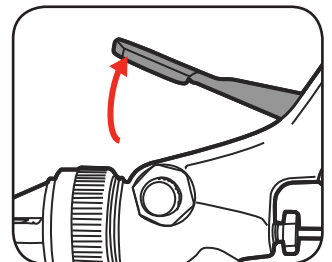

Note: The further the variable trigger is pressed, the more fluid will flow through the gun.

Spray Regulator Dial

The spray regulator dial is a stop that limits the distance the trigger can be pressed and can therefore limit the amount of paint being sprayed.

- 1 Fully tighten the spray regulator dial.

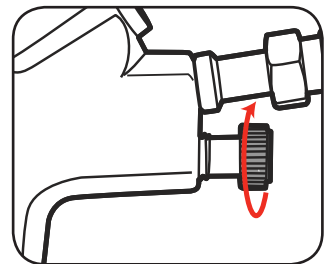

- 2 Slightly loosen the spray regulator dial, then test setting on a scrap piece of material.

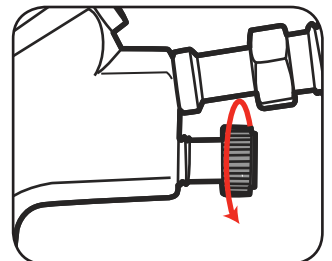

- 3 Repeat step 2 until desired fluid output is reached.

4. ADJUSTING THE SPRAY GUN CONT.

Fan Adjustment Dial

The fan adjustment dial controls the distribution of paint in the fan. Fully tightened, paint is concentrated in the centre of the fan, loosened the paint is more evenly distributed through out the fan.

- 1 Start with the fan adjustment dial completely loosened.

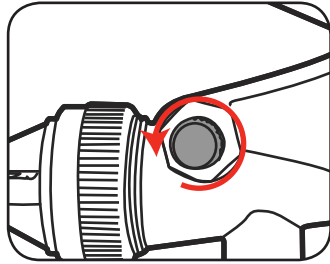

- 2 Partly tighten the dial then test setting on a scrap piece of material.

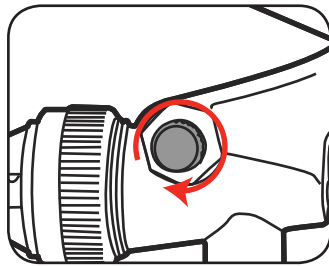

- 3 Repeat step 2 until desired fan pattern is reached.

Choosing Spray Patterns

- 1 To change spray pattern, loosen the nozzle collar and rotate the nozzle to desired position. Tighten nozzle collar to secure nozzle in place.

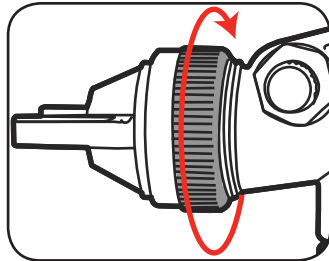

For vertical surfaces:

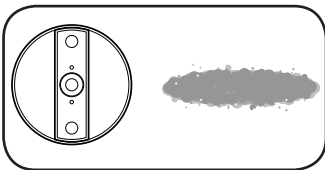

For horizontal surfaces:

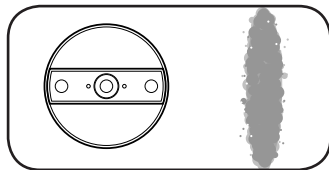

5. SPRAYING TECHNIQUE

1. Move the gun with the entire arm, not by flexing the wrist. This will keep the spray gun at right angles to the surface, keeping the pattern even.

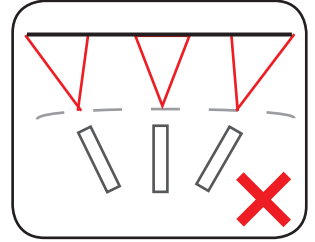
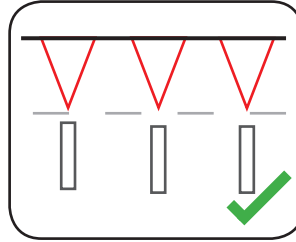

2. Keep the spray gun perpendicular to the surface, so spray distance is consistent.

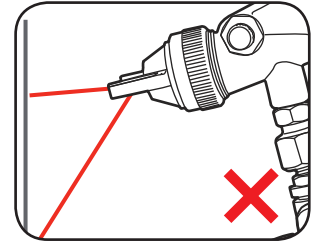
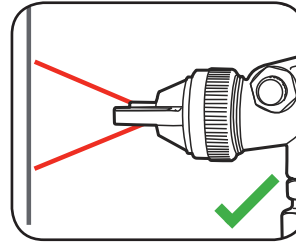

- 3 Begin 15cm off the edge of the area being sprayed. Start the movement of the stroke before squeezing the trigger. Release trigger once passed the opposite edge of the workpiece.

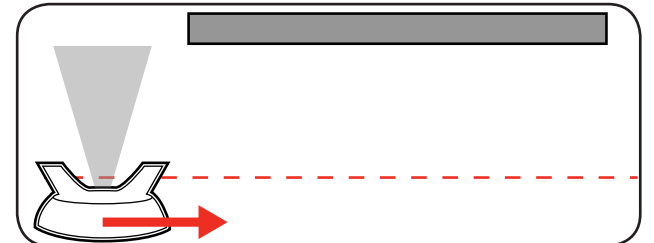

- 3 Overlap each stroke by 2cm to achieve an even coverage.

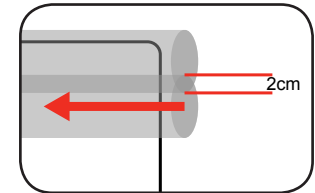

IT IS CRUCIAL TO CLEAN THE SPRAY GUN AFTER EACH USE. Please refer to the cleaning procedure.

Helpful Hints

1. Maintain the same distance from workpiece (approx 15cm) throughout each pass.
2. Maintain the same speed throughout each pass.
3. Always allow a coat to completely dry before adding another coat.
4. Avoid stopping and starting in the middle of workpiece as this can lead to a patchy finish.

CLEANING PROCEDURE

NOTE: After each use it is essential that the spray gun is cleaned thoroughly. Failure to do so will likely cause blockages which will prevent the tool from working. **FAILURE TO CLEAN THE TOOL WILL VOID THE WARRANTY.**

If oil based paint was used, use a solvent such as turps for cleaning. If water based paint was used, use water for cleaning.

- 1 Empty the paint pot of remaining material.

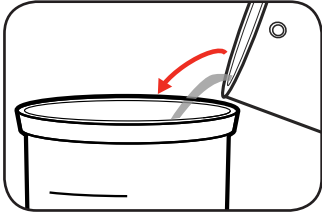

- 2 Fill paint pot with appropriate cleaning solution.

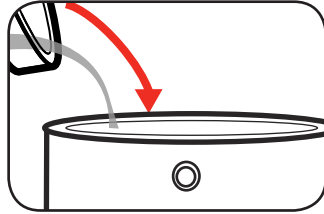

- 3 Connect the spray gun to the air supply then spray solution onto a scrap piece of carboard.

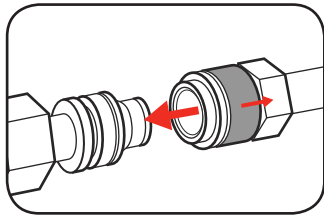

- 4 Repeat steps 2-3 until the cleaning solution runs clear from gun.

- 5 Remove the paint pot and rinse.

- 6 Disconnect the spray gun from the air supply.

Cleaning Parts

- 1 Unscrew and remove the nozzle collar.

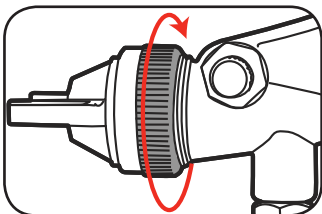

- 2 Dip a cloth in cleaning solution, then clean the nozzle collar, nozzle, paint pot vent, suction tube and gun housing.

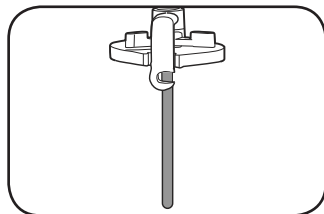

- 3 Take note of the 4 holes on the nozzle, if blocked clean carefully using a small needle.

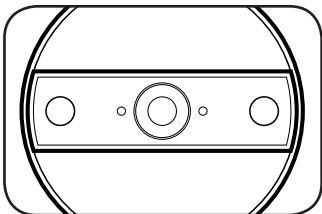

- 4 Prior to storing the spray gun, ensure it is completely dry.

TROUBLE SHOOTING

Problem	Cause	Remedy
Little or no material flow	Nozzle clogged Fluid regulator to limited Paint pot vent hole blocked Paint too thick	Clean Unscrew fluid regulator Clean Thin material
Material leaking	Nozzle loose Nozzle worn Material build up on air cap and nozzle	Tighten Replace Clean
Spray pattern is heavy in the middle	Nozzle clogged Not enough atomizing pressure	Clean Unscrew the air regulator
Spray pattern is too wide and misty	Too much atomizing pressure	Screw in the air regulator or decrease air pressure at the supply
Spray jet pulsates	Material in paint pot running out Nozzle clogged Material too thick	Refill Clean or replace Thin material
Pattern runs or sags	Applying to much material	Decrease fluid regulator or increase movement speed
Too much overspray	Gun too far from spray object Too much material applied	Reduce distance Decrease fluid regulator
Pattern is very light and splochy	Moving the spray gun to fast	Decrease fluid regulator or decrease movement speed

DESCRIPTION OF SYMBOLS

	Warning		Read instruction manual
	Wear ear protection		Wear eye protection and breathing mask
ml/min	Millilitres per minute	cfm	Cubic feet per minute

SPARE PARTS

Air Regulator Assembly
Air Cap
Nozzle Assembly
Sealing Ring
Needle Assembly

SPASGPRO-17A
SPASGPRO-03
SPASGPRO-5A
SPASGPRO-36
SPASGPRO-13A

Spare parts can be ordered from the Special Orders Desk at your local Bunnings Warehouse.

For further information, or any parts not listed here, visit www.ozito.com.au or contact Ozito Customer Service:

Australia 1800 069 486

New Zealand 0508 069 486

E-mail: enquires@ozito.com.au

MAINTENANCE

- Keep the the spray gun clean at all times. If possible, prevent foreign matter from entering the internals.
- If the body of the spray gun requires cleaning, never immerse any part of the spray gun into a liquid.

Note: Ozito Industries will not be responsible for any damage or injuries caused by the repair of the spray gun by an unauthorised person or by mishandling of the spray gun.

CARING FOR THE ENVIRONMENT



Power tools that are no longer usable should not be disposed of with household waste but in an environmentally friendly way. Please recycle where facilities exist. Check with your local council authority for recycling advice.



Recycling packaging reduces the need for landfill and raw materials. Reuse of recycled material decreases pollution in the environment. Please recycle packaging where facilities exist. Check with your local council authority for recycling advice.

SPARE PARTS

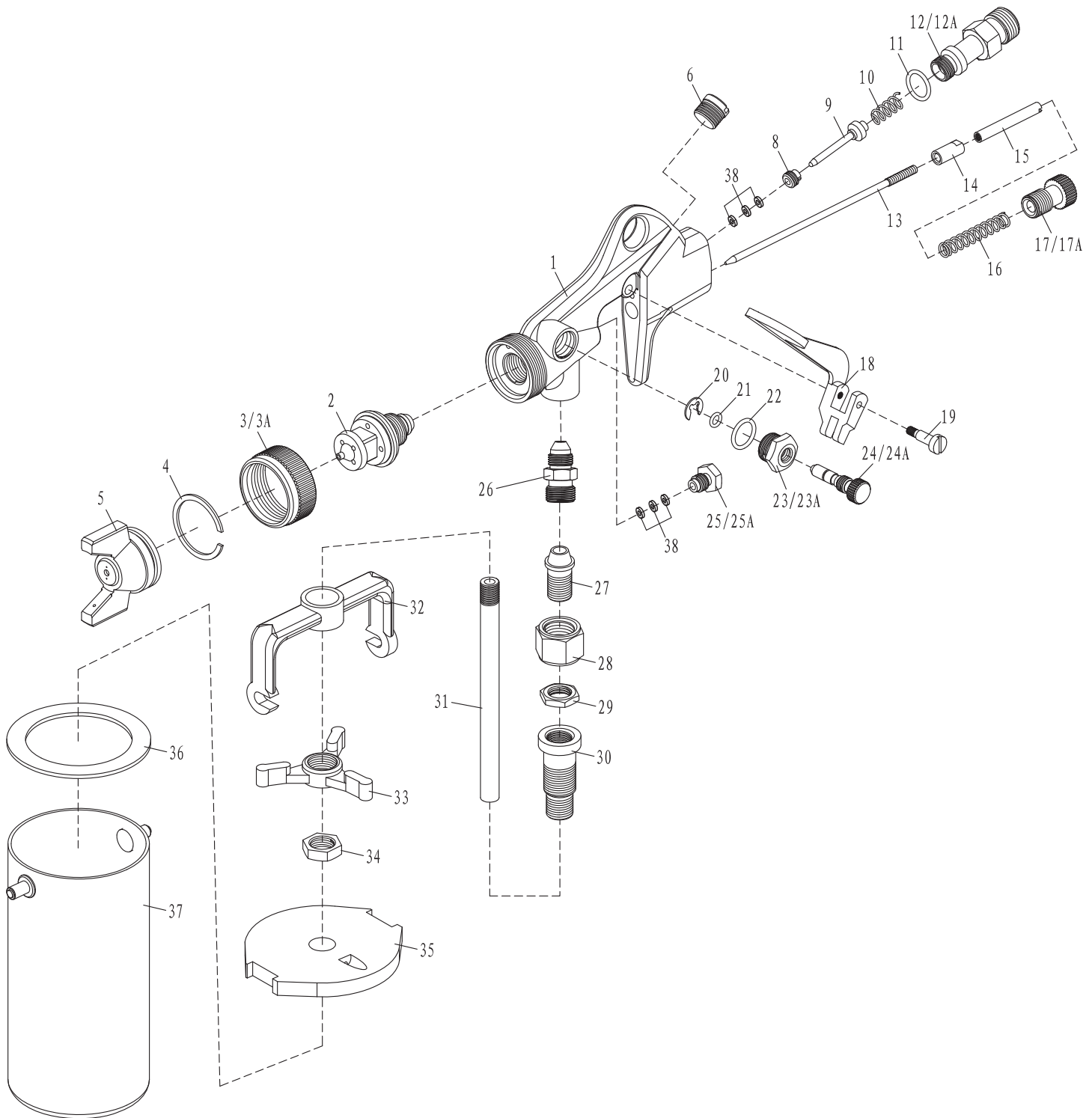

How To Order

Available spare parts can be ordered through the Special Orders Desk at any Bunnings Warehouse. If you have any further questions, please contact Ozito Customer Service on:

Australia: 1800 069 486

New Zealand: 0508 069 486

enquiries@ozito.com.au

GENERAL AIR TOOL SAFETY WARNINGS

 **WARNING!** Read all safety warnings and all instructions. Failure to follow the warnings and instructions may result in electric shock, fire and/or serious injury.

Save all warnings and instructions for future reference. The term “power tool” in the warnings refers to your mains-operated (corded) power tool or battery-operated (cordless) power tool.

1. Work area safety

- a. **Keep work area clean and well lit.** Cluttered or dark areas invite accidents.
- b. **Do not operate power tools in explosive atmospheres, such as in the presence of flammable liquids, gases or dust.** Power tools create sparks which may ignite the dust or fumes.
- c. **Keep children and bystanders away while operating a power tool.** Distractions can cause you to lose control.
- d. **Dress properly. Do not wear loose clothing or jewellery. Keep your hair, clothing and gloves away from moving parts.** Loose clothes, jewellery or long hair can be caught in moving parts.
- e. Check the maximum pressure rating of any tools or accessories that you intend using with the compressor. The output pressure of the air from the compressor must be regulated so that it never exceeds the rated pressure of the tool or accessory.
- f. Always wear safety goggles or glasses when using the air compressor. Never point the nozzle of an accessory towards any part of your body or towards another person.
- g. **Drain the moisture from the tank daily.** It will help prevent corrosion.
- h. Use safety equipment including safety goggles or shield, ear protection, breathing or respirator mask and protective clothing.
- i. The tool must be used only for its prescribed purpose. Any use other than those mentioned in this Manual will be considered a case of misuse. The user and not the manufacturer shall be liable for any damage or injury resulting from such cases of misuse.

 **WARNING!** In the event that an air line is cut or broken, the air supply must be turned off at the compressor. A broken air line which is not supported is extremely dangerous and can whip around very quickly, both with the capability of striking people, and blowing foreign particles into the air.

- Do not attempt to catch the air line but immediately keep bystanders well clear and turn off the air supply to the hose, turn off the compressor at the On / Off button, and then remove the hose from the compressor.
- This appliance is not intended for use by persons (including children) with reduced physical, sensory or mental capabilities, or lack of experience and knowledge, unless they have been given the supervision or instruction concerning use of the appliance by a person responsible for their safety.
- Children should be supervised to ensure that they do not play with the appliance.

SPRAY GUN SAFETY WARNINGS

 **WARNING!** This appliance is not intended for use by persons (including children) with reduced physical, sensory or mental capabilities, or lack of experience and knowledge, unless they have been given supervision or instruction concerning use of the appliance by a person responsible for their safety.

Using an Extension Hose

Always use an approved extension hose suitable for the air input of this tool. Before use, inspect the hose for signs of damage, wear and ageing. Replace the extension hose if damaged or defective.

When using an hose on a reel, always unwind the lead completely.

It is recommended that the hose is a maximum of 25m in length.

NEVER under any circumstances aim the nozzle at another person or animal.

- In the event of an injury occurring, seek medical advice immediately.
- The spray gun must not be used for spraying flammable paints and solvents with a flash point of less than 21°C.
- Always ensure there is adequate ventilation when spraying.
- The use of ear protection is recommended.
- Eye protection is recommended to keep hazardous vapours and liquids out of eyes.
- Always wear a face mask when spraying.
- Always read the paint manufacturers thinning instructions before using.
- Always keep the spray nozzle in place during use. Never allow the spray to come in direct contact with the skin.
- Never immerse the spray gun in liquid.

- The spray gun must not be cleaned by using flammable liquids with a flash point of less than 21°C.

NEVER spray near a naked flame, including an appliance pilot light.

NEVER smoke whilst spraying.

NEVER allow children to operate or play with the spray gun.

- Before cleaning, always disconnect the appliance from the air supply.

- Always disconnect from air supply when refilling the paint pot.

- After every use ensure you clean your spray gun thoroughly.

NEVER use the spray gun outside when it is raining.

WARRANTY

IN ORDER TO MAKE A CLAIM UNDER THIS WARRANTY YOU MUST RETURN THE PRODUCT TO YOUR NEAREST BUNNINGS WAREHOUSE WITH YOUR BUNNINGS REGISTER RECEIPT. PRIOR TO RETURNING YOUR PRODUCT FOR WARRANTY PLEASE TELEPHONE OUR CUSTOMER SERVICE HELPLINE:

Australia 1800 069 486

New Zealand 0508 069 486

TO ENSURE A SPEEDY RESPONSE PLEASE HAVE THE MODEL NUMBER AND DATE OF PURCHASE AVAILABLE. A CUSTOMER SERVICE REPRESENTATIVE WILL TAKE YOUR CALL AND ANSWER ANY QUESTIONS YOU MAY HAVE RELATING TO THE WARRANTY POLICY OR PROCEDURE.

The benefits provided under this warranty are in addition to other rights and remedies which are available to you at law.

Our goods come with guarantees that cannot be excluded at law. You are entitled to a replacement or refund for a major failure and for compensation for any other reasonably foreseeable loss or damage. You are also entitled to have the goods repaired or replaced if the goods fail to be of acceptable quality and the failure does not amount to a major failure.

Generally you will be responsible for all costs associated with a claim under this warranty, however, where you have suffered any additional direct loss as a result of a defective product you may be able to claim such expenses by contacting our customer service helpline above.

3 YEAR REPLACEMENT WARRANTY

Your product is guaranteed for a period of **36 months from the original date of purchase** and is intended for DIY (Do It Yourself) use only. If a product is defective it will be replaced in accordance with the terms of this warranty. Warranty excludes consumable parts.

WARNING

The following actions will result in the warranty being void.

- If the tool has been operated on a supply voltage other than that specified on the tool.
- If the tool shows signs of damage or defects caused by or resulting from abuse, accidents or alterations.
- Failure to perform maintenance as set out within the instruction manual.
- If the tool is disassembled or tampered with in any way.
- Professional, industrial or high frequency use.