



OIL FREE V-TWIN AIR COMPRESSOR

- ***POWERFUL 3.0HP MOTOR***
- ***OIL FREE & LOW MAINTENANCE***
- ***DUAL QUICK RELEASE NITTO COUPLINGS***
- ***50L TANK CAPACITY***



INSTRUCTION MANUAL



WARNING: Read all safety warnings and all instructions. Failure to follow the warnings and instructions may result in electric shock, fire and/or serious injury. Save all warnings and instructions for future reference.

SPECIFICATIONS - MODEL NO. FBVTAC-5030

Mains Voltage: 230-240V ~ 50Hz

Input Power: 2,200W (3.0HP)

No Load Speed: 2850/min

Free Air Delivery (FAD): 175L/min

Max. Air Delivery (MAD): 403L/min

Tank Volume: 50L

Max. Working Pressure: 10bar (145psi)

IP Rating IP20

Weight: 42 kg

Free Air Delivery: The free air delivery value was measured in accordance with Clause 4.2 of AS 4637

KNOW YOUR PRODUCT

Fasteners

- a. Wheel Bolts x 2
- b. Washers x 2
- c. Spring Washers x 2
- d. Hex Nuts x 2
- e. Nyloc Nuts x 2
- f. Fastening Knobs x 4

Air Compressor

- 1. On/Off Switch
- 2. Transport Handle
- 3. Pressure Tank
- 4. Support Feet
- 5. Drain Valve
- 6. Wheels
- 7. Air Filters
- 8. Overload Reset Switch
- 9. Tank Pressure Gauge
- 10. Safety Relief Valve
- 11. Unregulated Pressure Outlet
- 12. Pressure Regulator
- 13. Regulated Pressure Outlet
- 14. Regulated Pressure Gauge

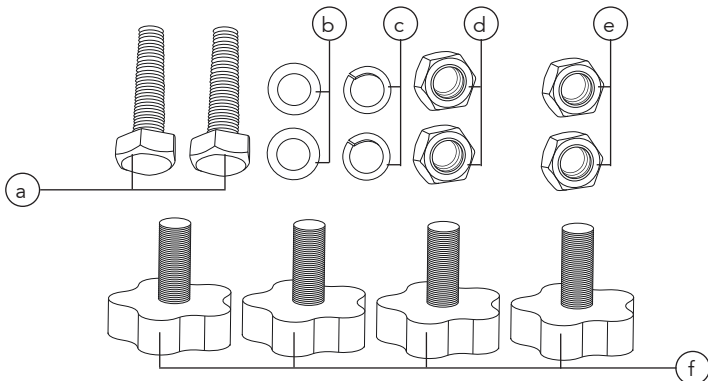

KNOW YOUR PRODUCT

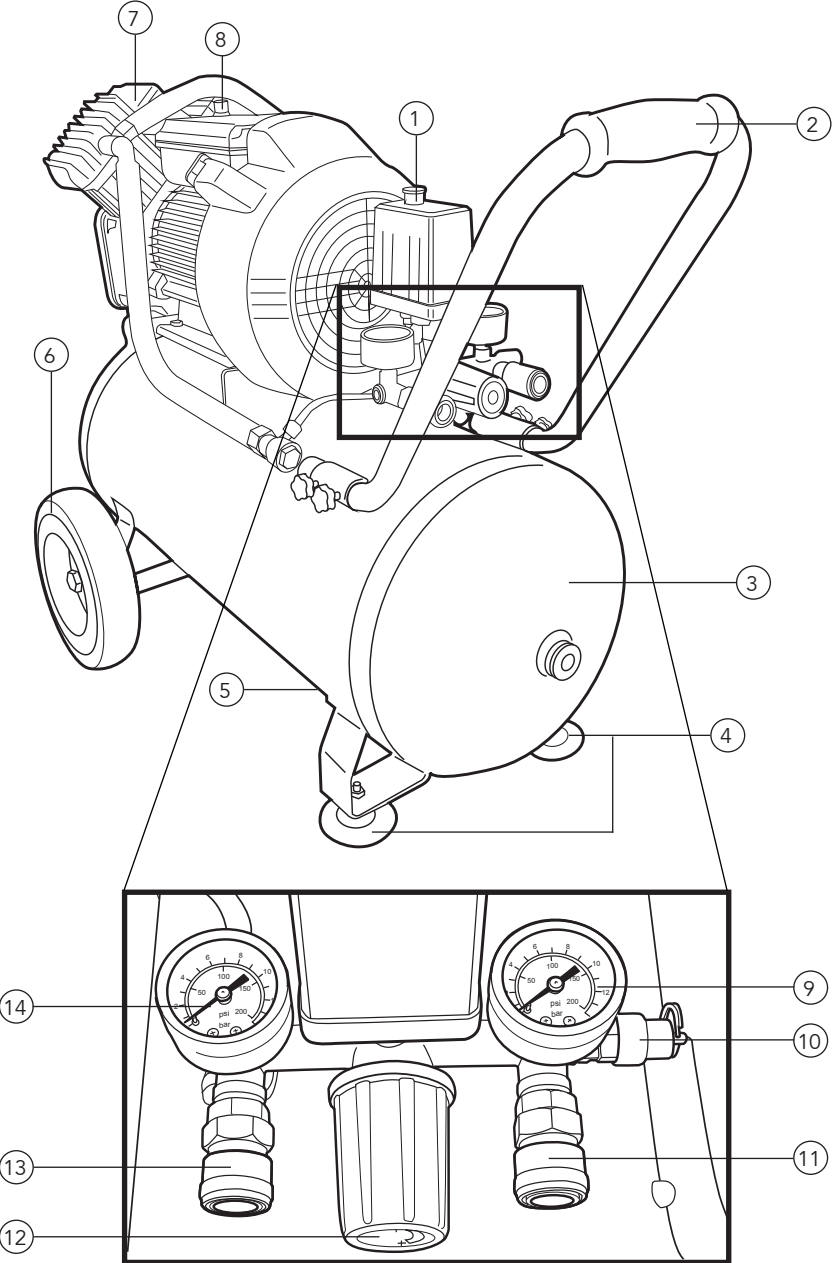

TABLE OF CONTENTS

SPECIFICATIONS.....	Page 02
KNOW YOUR PRODUCT.....	Page 02
INTRODUCTION.....	Page 05
SAFETY INSTRUCTIONS.....	Page 05
ASSEMBLY.....	Page 10
CONTROLS.....	Page 13
OPERATION.....	Page 16
MAINTENANCE.....	Page 18
TROUBLE SHOOTING.....	Page 20
DESCRIPTION OF SYMBOLS.....	Page 21
CONTENTS.....	Page 22
WARRANTY.....	Page 24

INTRODUCTION

Congratulations on purchasing a Full Boar Oil-Free V-Twin Air Compressor.

Your Oil-Free V-Twin Air Compressor has been designed to power a wide range of low to high air volume tools up to 10bar.

ELECTRICAL SAFETY



WARNING! When using mains-powered equipment, basic safety precautions, including the following, should always be followed to reduce the risk of fire, electric shock, personal injury and material damage.

Read and understand the manual prior to operating this tool.

Save these instructions and other documents supplied with this tool for future reference.

The electric motor has been designed for 230V and 240V only. Always check that the power supply corresponds to the voltage on the rating plate.

Note: The supply of 230V and 240V on Full Boar tools are interchangeable for Australia and New Zealand.

To reduce the risk of electric shock, a residual current device (rated 30mA or less) must be used.

If the supply cord is damaged, it must be replaced by an electrician or a power tool repairer in order to avoid a hazard.

Using an Extension Lead

Always use an approved extension lead suitable for the power input of this tool. Before use, inspect the extension lead for signs of damage, wear and ageing. Replace the extension lead if damaged or defective. When using an extension lead on a reel, always unwind the lead completely. Use of an extension lead not suitable for the power input of the tool or which is damaged or defective may result in a risk of fire and electric shock.

GENERAL POWER TOOL SAFETY WARNINGS



WARNING! Read all safety warnings and instructions. Failure to follow all instructions listed below may result in electric shock, fire and/or serious injury. The term 'Power Tool' in all of the warnings listed below refers to your mains operated (corded) power tool or battery operated (cordless) power tool.

1. Work area safety

- a. **Keep work area clean and well lit.** Cluttered or dark areas invite accidents.
- b. **Do not operate power tools in explosive atmospheres, such as in the presence of flammable liquids, gases or dust.** Power tools create sparks which may ignite the dust or fumes.
- c. **Keep children and bystanders away while operating a power tool.** Distractions can cause you to lose control.

2. Electrical safety

- a. **Power tool plugs must match the outlet. Never modify the plug in any way. Do not use any adapter plugs with earthed (grounded) power tools.** Unmodified plugs and matching outlets will reduce risk of electric shock.
- b. **Avoid body contact with earthed or grounded surfaces, such as pipes, radiators, ranges and refrigerators.** There is an increased risk of electric shock if your body is earthed or grounded.
- c. **Do not expose power tools to rain or wet conditions.** Water entering a power tool will increase the risk of electric shock.
- d. **Do not abuse the cord. Never use the cord for carrying, pulling or unplugging the power tool. Keep cord away from heat, oil, sharp edges or moving parts.** Damaged or entangled cords increase the risk of electric shock.
- e. **When operating a power tool outdoors, use an extension cord suitable for outdoor use.** Use of a cord suitable for outdoor use reduces the risk of electric shock.

3. Personal safety

- a. **Stay alert, watch what you are doing and use common sense when operating a power tool. Do not use a power tool while you are tired or under the influence of drugs, alcohol or medication.** A moment of inattention while operating power tools may result in serious personal injury.
- b. **Use personal protective equipment. Always wear eye protection.** Protective equipment such as dust mask, non-skid safety shoes, hard hat, or hearing protection used for appropriate conditions will reduce personal injuries.
- c. **Prevent unintentional starting. Ensure the switch is in the off-position before connecting to power source and/or battery pack, picking up or carrying the tool.** Carrying power tools with your finger on the switch or energising power tools that have the switch on invites accidents.
- d. **Remove any adjusting key or wrench before turning the power tool on.** A wrench or a key left attached to a rotating part of the power tool may result in personal injury.
- e. **Do not overreach. Keep proper footing and balance at all times.** This enables better control of the power tool in unexpected situations.
- f. **Dress properly. Do not wear loose clothing or jewellery. Keep your hair, clothing and gloves away from moving parts.** Loose clothes, jewellery or long hair can be caught in moving parts.
- g. **If devices are provided for the connection of dust extraction and collection facilities, ensure these are connected and properly used.** Use of dust collection can reduce dust-related hazards.
- h. **Do not let familiarity gained from frequent use of tools allow you to become complacent and ignore tool safety principles.** A careless action can cause severe injury within a fraction of a second.

4. Power tool use and care

- a. Do not force the power tool. Use the correct power tool for your application. The correct power tool will do the job better and safer at the rate for which it was designed.
- b. **Do not use the power tool if the switch does not turn it on and off.** Any power tool that cannot be

GENERAL POWER TOOL SAFETY WARNINGS

- controlled with the switch is dangerous and must be repaired.
- c. **Disconnect the plug from the power source and/or the battery pack from the power tool before making any adjustments, changing accessories, or storing power tools.** Such preventive safety measures reduce the risk of starting the power tool accidentally.
 - d. **Store idle power tools out of the reach of children and do not allow persons unfamiliar with the power tool or these instructions to operate the power tool.** Power tools are dangerous in the hands of untrained users.
 - e. **Maintain power tools. Check for misalignment or binding of moving parts, breakage of parts and any other condition that may affect the power tool's operation. If damaged, have the power tool repaired before use.** Many accidents are caused by poorly maintained power tools.
 - f. **Keep cutting tools sharp and clean.** Properly maintained cutting tools with sharp cutting edges are less likely to bind and are easier to control.
 - g. **Use the power tool, accessories and tool bits etc. in accordance with these instructions, taking into account the working conditions and the work to be performed.** Use of the power tool for operations different from those intended could result in a hazardous situation.
 - h. **Keep handles and grasping surfaces dry, clean and free from oil and grease.** Slippery handles and grasping surfaces do not allow for safe handling and control of the tool in unexpected situations.
- 5. Service**
- a. **Have your power tool serviced by a qualified repair person using only identical replacement parts.** This will ensure that the safety of the power tool is maintained.

AIR COMPRESSOR SAFETY WARNINGS



WARNING! Before connecting a tool to a power source (mains switch, power point, receptacle, outlet, etc.) be sure that the voltage supply is the same as that specified on the nameplate of the tool. A power source with a voltage greater than that specified for the tool can result in serious injury to the user, as well as damage to the tool. If in doubt, do not plug in the tool. Using a power source with a voltage less than the nameplate rating is harmful to the motor.

Always remove the plug from the mains socket before making any adjustments or performing maintenance.

This appliance is not intended for use by young or infirm persons unless supervised by a responsible person to ensure that they can use the appliance safely. Young children should be supervised to ensure that they do not play with the appliance.

- To reduce the risk of fire or explosion, never spray flammable liquids in a confined area. It is normal for the compressor motor and pressure switch to produce sparks during use. If sparks come into contact with petrol vapours or solvents, they may ignite the vapours and cause a fire or explosion.
- Always operate the compressor in a well ventilated area. Do not smoke while spraying. Do not spray where sparks or flames are present. Keep the compressor as far away from the spray area as possible.
- The solvents trichloroethane and methylene chloride can chemically react with the aluminium used in some paint spray guns and form an explosion. If these solvents are used, ensure that only stainless steel spray equipment is connected. The compressor is not affected by the use of these solvents.
- Never directly inhale the compressed air produced by a compressor and do not use it for charging breathing tanks.
- Do not use welding equipment in close proximity to the compressor. Do not weld anything to the air tank of the compressor: this could dangerously weaken the tank and void the warranty.
- Do not use the compressor outdoors when it is raining or on a wet surface; either situation could cause an electric shock.
- Always shut off the compressor after use and before servicing. Push the on/off knob down, wait for the pressurised air to bleed from the tank from the safety valve and then remove the electrical plug from the power supply.
- Check the maximum pressure rating of any tools or accessories that you intend using with the compressor. The output pressure of the air from the compressor must be regulated so that it never exceeds the rated pressure of the tool or accessory.
- To avoid the risk of burns and injury from moving parts, do not operate the compressor with the safety shield removed. Allow hot parts to cool before handling or servicing.
- Be certain to read all the labels on the containers of paint or other materials to be sprayed. Closely follow all safety instructions. Use a respirator mask if there is a chance that you might otherwise inhale the spray material. Carefully check the effectiveness of any respirator mask you intend using.
- Always wear safety goggles or glasses when using the air compressor. Never point the nozzle of an accessory towards any part of your body or towards another person.
- Do not attempt to adjust the pressure switch or the release valve located under the pressure switch cover.
- Drain the moisture from the tank after use. It will help prevent corrosion.
- Pull the ring on the safety valve daily to ensure that it is operating properly and to clear any possible debris from the outlet.
- Keep the compressor at least 300mm from the nearest wall to ensure adequate ventilation for cooling purposes.
- Before transporting the compressor make sure that the pressurised air is bled from the tank and that the compressor is firmly secured.
- Protect the air hose and cordset from damage. Inspect for weak or worn spots regularly and replace if necessary.
- Avoid using an extension cord with this product. Use additional air hose instead of an extension cord to prevent power loss and possible damage to the motor.

AIR COMPRESSOR SAFETY WARNINGS

- After long working periods external metal parts could be hot.
- Always press the on/off button down to switch off the compressor before switching off the power or removing the power plug.
- After using the compressor, switch off the on/off button, disconnect the power supply and open the outlet valve to release the pressure.
- Never attempt to remove any part of the compressor whilst the tank is under pressure.

Wear goggles, wear ear muffs, wear a breathing mask

Never apply the outlet air of this compressor directly on to any part of a persons body. Do not attempt to block the air outlet with your finger or any part of your body.

The tool must be used only for its prescribed purpose. Any use other than those mentioned in this Manual will be considered a case of misuse. The user and not the manufacturer shall be liable for any damage or injury resulting from such cases of misuse.

The manufacturer shall not be liable for any changes made to the tool nor for any damage resulting from such changes.

Even when the tool is used as prescribed it is not possible to eliminate all residual risk factors. The following hazards may arise in connection with the tools construction and design:

- Damage to the lungs if an effective breathing mask is not worn.
- Damage to hearing if effective earmuffs are not worn.
- Damage to the eyes if effective safety goggles or shield are not worn.



WARNING! In the event that an air line is cut or broken, the air supply must be turned off at the compressor. A broken air line which is not supported is extremely dangerous and can whip around very quickly, both with the capability of striking people and blowing foreign particles into the air.

Do not attempt to catch the air line but immediately keep bystanders well clear, turn off the compressor at the On/Off Switch, and then remove the hose from the compressor.

ASSEMBLY



WARNING! Ensure the tool is turned off and disconnected from the power supply before performing any of the following operations.

Pre-Setup Checks

Examine the machine for signs of transit damage. If there are any signs of damage, please contact the Customer Support on:

Australia 1800 069 486

New Zealand 0508 069 486

- The compressor should be set up near the working area.
- Avoid long air lines and long supply lines (extensions). It is preferable to use longer airlines than longer supply lines if extension is needed.
- Make sure the intake air is dry and dust-free.
- Do not set up the compressor in damp or wet areas.
- The compressor may only be used in suitable areas (with good ventilation and an ambient temperature from 5°C to +40°C). There must be no dust, acids, vapours, explosive gases or flammable gases in the room.

Attaching The Support Feet

1. With the pressure tank (3) on its side, insert the bolt on one of the support feet (4) through the hole in the frame of the tank.

Note: The support feet should go on the front of the tank. The front end of the tank has 2 horizontal tubes on the top where the handle will be attached.

2. Use one of the supplied Nyloc nuts (e) to secure the support foot (4) to the frame.

Note: The Nyloc nuts have a blue/black Nylon ring on the inside. These should not be interchanged with the hex nuts used for fastening the wheels.

3. Repeat the same procedure on the other side of the tank (3) with the second support foot (4).

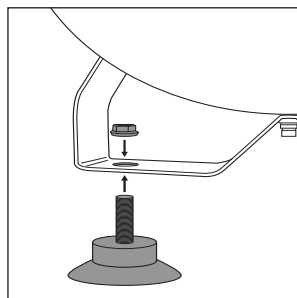
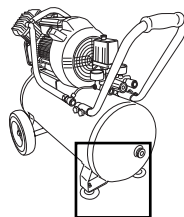

ASSEMBLY

Attaching The Wheels

1. Place a wheel bolt (a) through the wheel (6) and then slide this through the hole in the wheel bracket, below the tank (3).
2. Fasten the wheel bolt (a) in position with a washer (b), spring washer (c) and hex nut (d).
3. Repeat steps 1 and 2 to fit the second wheel (6) on the opposite side of the tank (3).

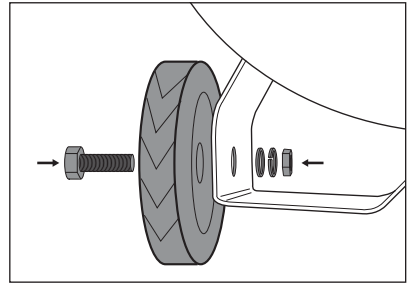
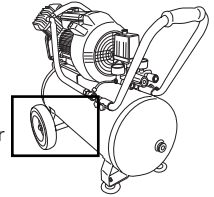

Attaching The Handle

1. Slide the handle (2) into the horizontal tubes on the tank (3).
2. Push the handle (2) as far into the tubes as possible. Insert a fastening knob (f) into the hole in the side of the cylinder and turn clockwise to tighten it.
3. Repeat Step 2 with the other 3 fastening knobs (f). There should be 2 fastening knobs (f) on each side of the handle (2).

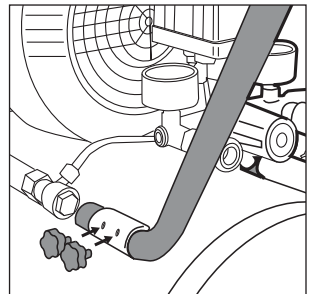
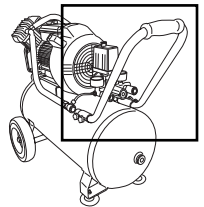

ASSEMBLY



WARNING! Ensure the tool is turned off and disconnected from the power supply before performing any of the following operations.

Attaching Air Tools

1. Align the Nitto head on an air hose with one of the pressure outlets (11, 13) on the air compressor.
2. Press the air hose head into the outlet coupling (11, 13) until it clicks into place.

Note: If the Nitto coupling is tight and does not click into place, pull the sleeve back on the female Nitto head and then press the fittings together until they click into place.

3. Repeat the same process above to connect an air tool onto the other end of the air hose.



WARNING! Ensure you have a firm grip on the air hose when disconnecting it from the air compressor, as pressurised air in the tank may cause it to whip around and inflict injury or damage.

Disconnecting Air Tools

1. To remove an air tool from the unit, retract the sleeve on the female Nitto fitting and disconnect the air hose from the air compressor.
2. Repeat the same procedure with the air tool and air hose.

CONTROLS



WARNING! The air compressor must be used with a residual current device with a rated residual current of 30mA or less.



WARNING! Do not leave the compressor unattended while the On/Off Switch is in the 'On' position.

Switching The Compressor On/Off

1. To switch the compressor on, pull up the on/off switch (1). Allow the motor to run and the tank to fill up.
2. The tank pressure gauge (9) provides a reading of the air pressure inside the compressor tank. Air flow out of the unregulated pressure outlet (11) will be at tank pressure.

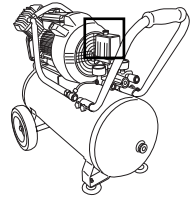

Note: The compressor will automatically cut off when the tank pressure reaches 10bar and will automatically start up again when the tank pressure drops to 8bar.

3. To switch the compressor off, press the on/off switch (1) down.

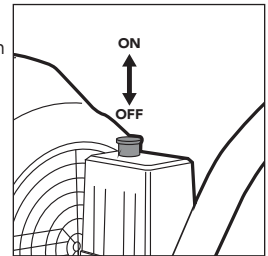

IMPORTANT! The motor is fitted with an overload switch. If the compressor overloads, the overload switch turns off the equipment automatically to protect the compressor from overheating. If the overload switch triggers, switch off the compressor using the On/Off Switch (1) and wait until the compressor cools down. Then press the Overload Reset Switch (8) and restart the compressor.

Do not continue use of the unit if the overload switch trips again immediately after the reset.

CONTROLS

Adjusting The Output Pressure

The output pressure of the regulated pressure outlet (13) can be adjusted to suit the air tool connected and the task at hand.

1. To do so, first decrease the pressure to 0psi by turning the pressure regulator (12) anti-clockwise.
2. Then turn the pressure regulator (12) clockwise until the desired pressure is shown on the regulated pressure gauge (14).

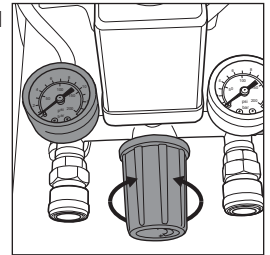
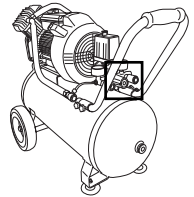

WARNING! Release all air pressure from the tank before opening the Drain Valve. Take care when discharging air through the Safety Valve, Drain Valve or air Outlets. The discharged air can cause dust, stones, or any other foreign particles to be blown through the air at high pressure.

Draining The Pressure Tank

Air in the compressor tank causes water to accumulate. This must be drained off frequently to prevent corrosion and damage to the unit. This should be performed after each use and prior to the next use.

1. Turn the drain valve plug (5) clockwise to open it.
2. Allow all of the water in the tank (3) to drain out.
3. Replace the drain valve plug (5) and turn it anti-clockwise to tighten it.

Note: The tank will not pressurise while the drain valve is open.

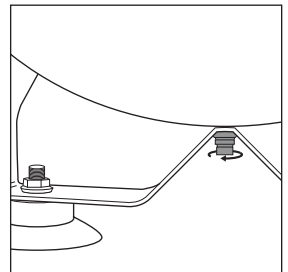
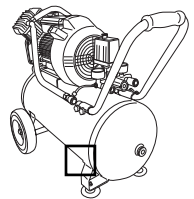

CONTROLS



WARNING! Wear safety glasses and ear protection. Keep your face away from the Safety Valve when carrying out this check. Air will be discharged at high pressure.

Do not use the compressor if the Safety Valve does not work as described.

Checking The Safety Relief Valve

The safety relief valve has been set for the highest permitted pressure of the tank. It is prohibited to adjust the safety relief valve or to remove its seal.

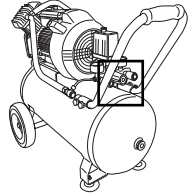

1. Check that the safety relief valve (10) is in working order before every use. Turn the compressor on until the switch off pressure (10bar) is reached.
2. Hold the ring on the safety relief valve (10) and pull it outwards. Air should discharge from the valve.
3. When the ring on the safety relief valve (10) is released, the air discharge should stop.

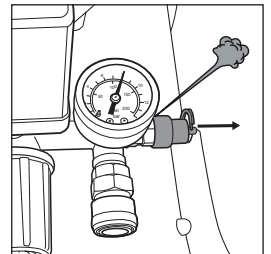
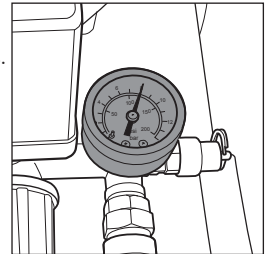

OPERATION



WARNING! Before connecting the compressor to the power source, check for broken components and accessories. Also check for damage to the hose. Do not proceed if any component or part shows sign of wear or damage. Replace the part or take it to an authorised repairer.

Starting Up The Compressor

For best practice, the compressor should be run without any load for 20 minutes before first use to lubricate the bearings and piston. This procedure should also be performed if the compressor has been stored for 6 months or more without operation.

1. Disconnect all air hoses from the outlets and open the drain valve (5) to prevent pressurised air buildup in the tank (3).
2. Make sure the power switch (1) is in the off position. Plug the power supply cord into a mains outlet and turn the unit on. Allow the compressor to run for 20 minutes without any loads attached.
3. Turn off the compressor, drain any liquid from the tank (3) and close the drain valve (5). The compressor is now ready for use.
4. Attach the desired tool to one end of an air hose and the air hose to an outlet (11, 13) depending on the tool or application.
5. Turn the compressor back on and adjust the regulated pressure to the desired level once the pump has shut off and the compressor has reached cut-off pressure (10bar).

OPERATION

Shutting Down The Compressor

Do not turn the air compressor off by unplugging it from the mains power as it may result in damage to the motor.

1. Turn the compressor off with the on/off switch (1) and then unplug the cord.
2. Rotate the pressure regulator (12) anti-clockwise until it is fully closed; check the regulated pressure gauge (14) to ensure that it reads 0psi. Also turn on the air tool to discharge any remaining pressurised air in the air hose.
3. Remove the air hose and any other connected accessories.
4. Slowly open the safety relief valve (10) to release any remaining pressurised air. When no more air is released, open the drain valve (5) to release any accumulated liquid from the tank.
5. Close the drain valve (5), allow the compressor to cool down, then clean and store the unit.

MAINTENANCE



WARNING! Before cleaning your air compressor or carrying out any maintenance procedure, make sure that it is disconnected from the power supply to prevent accidental starting.



IMPORTANT! Never turn on the air compressor without the filters. Check that the filters are securely fitted at all times.

Cleaning The Air Filters

The air filters prevent dust and dirt being drawn in. It is essential to clean these filters at least after every 300 hours in service. Clogged air filters will decrease the performance of the compressor dramatically.

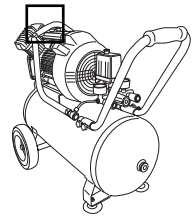

1. Allow the compressor to run and collect pressurised air in the tank. Once the motor has stopped running, turn the compressor off and disconnect it from the power supply.
2. With an air hose and blow gun connected to the regulated pressure outlet (13), turn the pressure regulator (12) until the regulated pressure gauge (14) shows a pressure of around 3bar.
3. Unscrew the bolt on the air filter (7) housing with a hex key and remove the entire housing unit from the compressor.
4. Gently squeeze the bottom part of the housing to disengage the plastic tabs and pull off the lid.
5. Pull out the filter pads from the housing, tap it and spray it with the blow gun to remove any dirt. Re-insert it into the housing.
6. Re-attach the lid and screw the air filter (7) unit back onto the air compressor.
7. Repeat the above procedure for the other air filter (7) unit.

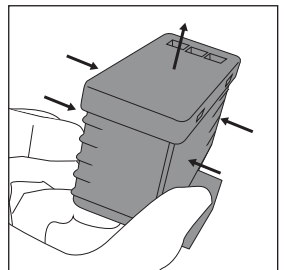
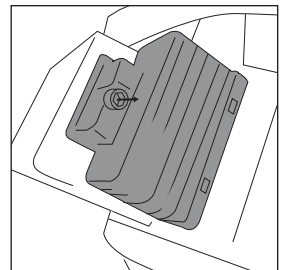

MAINTENANCE

Cleaning

1. Keep the safety devices free of dirt and dust as much as possible. Wipe the equipment with a clean cloth or blow it with compressed air at low pressure.
2. We recommend that you clean the appliance immediately after you use it.
3. Clean the appliance regularly with a damp cloth and some soft soap. Do not use cleaning agents or solvents; these may be aggressive to the plastic parts in the appliance. Ensure that no water can get into the interior of the appliance.
4. You must disconnect the hose and any spraying tools from the compressor before cleaning. Do not clean the compressor with water, solvents or the like.

Storage

Pull the mains plug out of the socket and ventilate the appliance and all connected pneumatic tools. Switch off the compressor and make sure that it is secured in such a way that it cannot be started up again by any unauthorised person.

Store the compressor only in a dry location which is not accessible to unauthorised persons.

Supply Cords









If the replacement of the supply cord is necessary, this has to be done by the manufacturer or his agent in order to avoid a safety hazard.

Note: Ozito Industries will not be responsible for any damage or injuries caused by the repair of the tool by an unauthorised person or by mishandling of the tool.

TROUBLE SHOOTING

Symptom	Possible Cause	Suggested Solution
The compressor does not start	Compressor has reached cut-out pressure	Compressor will automatically start once below the cut-in pressure
	No power supply	Check the power supply, the power plug and the socket-outlet.
	Insufficient supply power	Reduce length of extension lead.
	Outside temperature is too low	Never operate with an outside temperature of below 5°C.
	Motor is overheated	Allow the motor to cool down. If necessary, remedy the cause of the overheating.
	Overloaded	Reset overload switch
The compressor starts but there is no pressure	The seals are damaged.	Check the seals and have any damaged seals replaced by a service centre
	The drainage valve leaks.	Ensure it is properly closed.
The compressor starts, pressure is shown on the pressure gauge, but no pressure to the air tool.	Loose hose connections	Check the compressed air hose and tools and replace if necessary.
	Leak in a quick-lock coupling	Check the quick-lock coupling and replace if necessary.
	Insufficient pressure set on the pressure regulator.	Open the pressure regulator further.

DESCRIPTION OF SYMBOLS

V	Volts	Hz	Hertz
~	Alternating current	W	Watts
/min	Revolutions or reciprocation per minute	n₀	No load speed
	Warning		Electrical Emissions Conformity (EMC)
	Read instruction manual		Sound power level
	Beware of electrical voltage		Wear hearing protection
	Beware of hot parts.	IP20	Ingress protection from water
L	Litres	bar	Pressure rating
	Warning! The equipment is remote-controlled and may start-up without warning.		

CARING FOR THE ENVIRONMENT



Power tools that are no longer usable should not be disposed of with household waste but in an environmentally friendly way. Please recycle where facilities exist. Check with your local council authority for recycling advice.



Recycling packaging reduces the need for landfill and raw materials. Reuse of recycled material decreases pollution in the environment. Please recycle packaging where facilities exist. Check with your local council authority for recycling advice.

CONTENTS

1 x FBVTAC-5030 Air Compressor
2 x Wheels
2 x Wheel Bolt
2 x Washers
2 x Spring Washers
2 x Hex Nuts

2 x Rubber Support Feet
2 x Nyloc Nuts
1 x Transport Handle
4 x Handle Fastening Knobs
1 x Instruction Manual

Distributed by:
Ozito Industries Pty Ltd

AUSTRALIA (Head Office)

1-23 Letcon Drive, Bangholme Victoria, Australia, 3175

Telephone: 1800 069 486

WARRANTY

YOUR WARRANTY FORM SHOULD BE RETAINED BY YOU AT ALL TIMES. IN ORDER TO MAKE A CLAIM UNDER THIS WARRANTY YOU MUST RETURN THE PRODUCT TO YOUR NEAREST BUNNINGS WAREHOUSE (see www.bunnings.com.au or www.bunnings.co.nz for store locations) WITH YOUR BUNNINGS REGISTER RECEIPT. PRIOR TO RETURNING YOUR PRODUCT FOR WARRANTY PLEASE TELEPHONE OUR CUSTOMER SERVICE HELPLINE:

**Australia 1800 069 486
New Zealand 0508 069 486**

TO ENSURE A SPEEDY RESPONSE PLEASE HAVE THE MODEL NUMBER AND DATE OF PURCHASE AVAILABLE. A CUSTOMER SERVICE REPRESENTATIVE WILL TAKE YOUR CALL AND ANSWER ANY QUESTIONS YOU MAY HAVE RELATING TO THE WARRANTY POLICY OR PROCEDURE.

1 YEAR WARRANTY

Your product is guaranteed for a period of **12 months from the original date of purchase**. If a product is defective it will be repaired in accordance with the terms of this warranty. Warranty excludes consumable parts, for example: wheels, bearings.

The benefits provided under this warranty are in addition to other rights and remedies which are available to you under law. The warranty covers manufacturer defects in materials, workmanship and finish under normal use.

Our goods come with guarantees that cannot be excluded under Australian Consumer law & Consumer Guarantees Act 1993 (NZ). You are entitled to a replacement or refund for a major failure and to compensation for other reasonably foreseeable loss or damage. You are also entitled to have the goods repaired and replaced if the goods fail to be of acceptable quality and the failure does not amount to a major failure.

WARRANTY EXCLUSIONS

The following actions will result in the warranty being void.

- If the tool has been operated on a supply voltage other than that specified on the tool.
- If the tool shows signs of damage or defects caused by or resulting from abuse, accidents or alterations.
- Failure to perform maintenance as set out within the instruction manual.
- If the tool is disassembled or tampered with in any way.
- The warranty excludes damage resulting from product misuse or product neglect.

This warranty is given by Ozito Industries Pty Ltd.

ABN: 17 050 731 756

Ph.1800 069 486

Australia/New Zealand (Head Office)
1-23 Letcon Drive, Bangholme, Victoria, Australia 3175