

ozito

DIGITAL MINI COMPRESSOR

12V

INSTRUCTION MANUAL

SPECIFICATIONS

Voltage:	12V
Max Current:	10Amp
Max Pressure:	100psi
Flow Rate:	16 l/min
Weight:	1kg

ozito.com.au

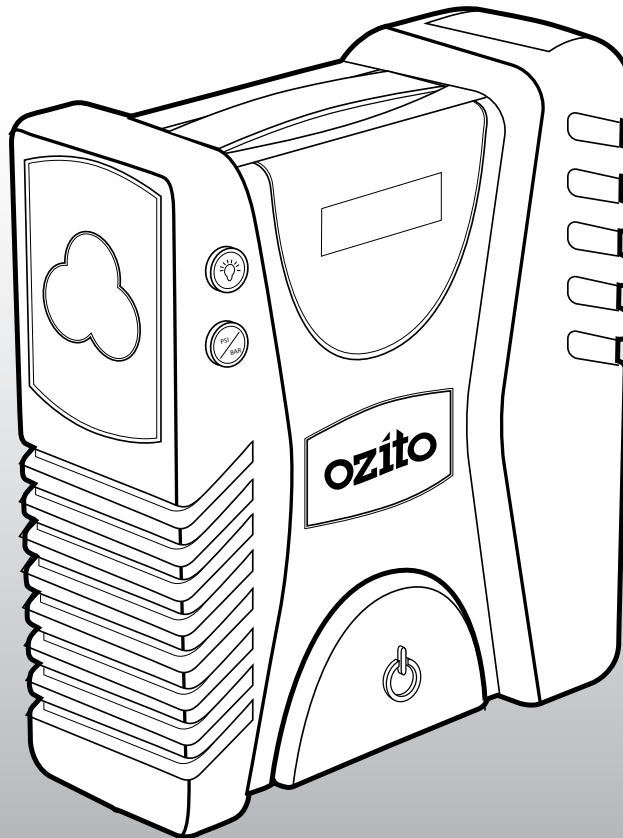

WHAT'S IN THE BOX

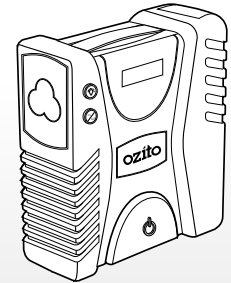

Digital Compressor



Accessories x 7

3 YEAR REPLACEMENT WARRANTY

DMC-1000

KNOW YOUR PRODUCT

FRONT VIEW

- | | |
|--------------------|--------------------------|
| 1 LED Light | 4 Digital Pressure Gauge |
| 2 Light Button | 5 Carry Handle |
| 3 PSI / BAR Button | 6 On/Off Button |
| | 7 Side Compartment |

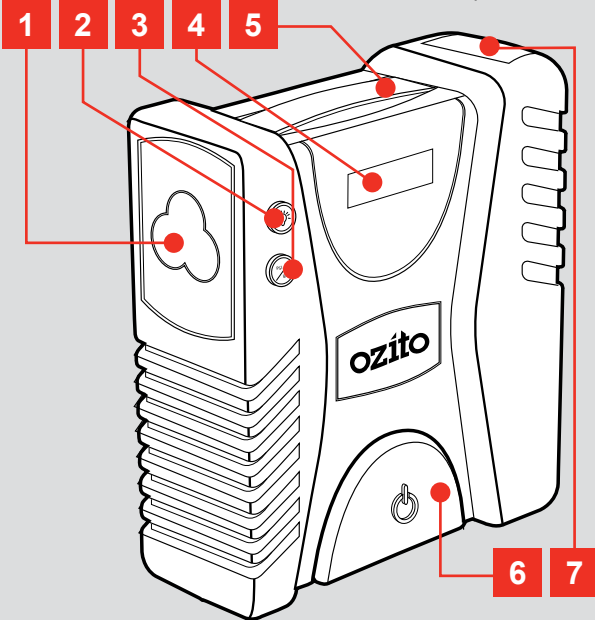

BACK / BASE VIEW

- | | |
|---------------------|---------------------------|
| 8 Air Hose | 11 Adaptor Storage |
| 9 12V Socket | 12 High Volume Air Outlet |
| 10 High Volume Hose | |

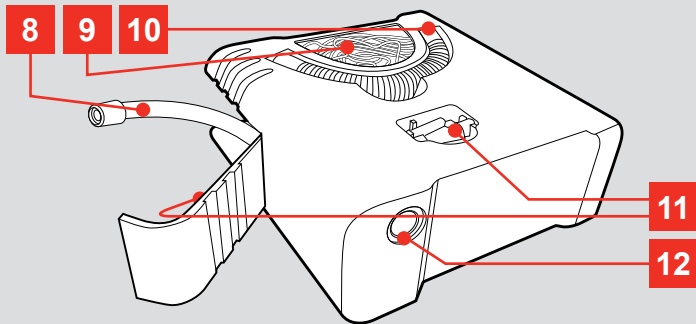

ACCESSORIES

- | | |
|--------------------------|-----------------------------|
| 13 High Pressure Adaptor | 16 General Purpose Adaptors |
| 14 Medium Adaptor | 17 Ball Adaptor |
| 15 Large Adaptor | |

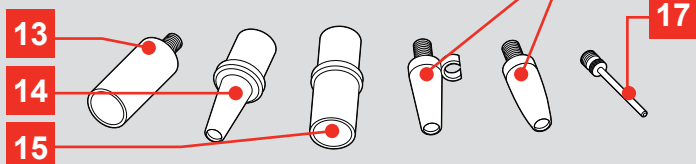

ONLINE MANUAL

Scan this QR Code with your mobile device to take you to the online manual.



SETUP & PREPARATION

1. ADAPTORS



WARNING: ENSURE THE TOOL IS SWITCHED OFF AND DISCONNECTED FROM THE POWER SUPPLY BEFORE PERFORMING ANY OF THE FOLLOWING STEPS.

Removing Adaptors

The compressor unit has 7 adaptors to allow a range of functions. All the adaptors are secured in either the compartment on the side or base.

Side Compartment

- To open the side compartment, slide the door up. Lower the door to expose the adaptors.

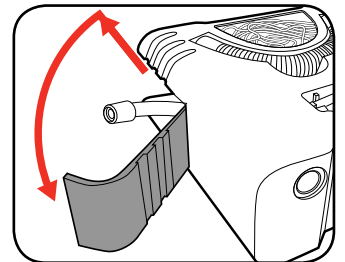

- The 3 adaptors and air hose can now be removed.

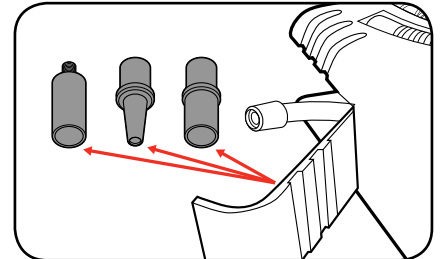

- To close the side compartment raise the door and slide down to secure.

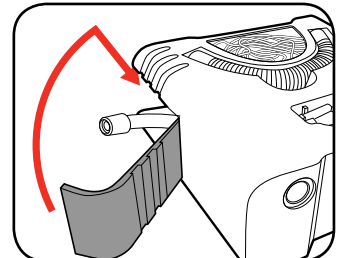

Base Compartment

- Turn the unit over so you can see the base.

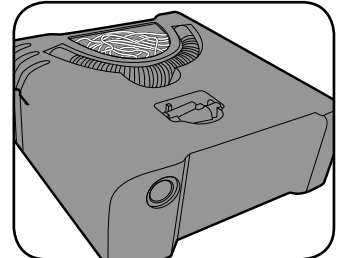

- Remove the required adaptor.

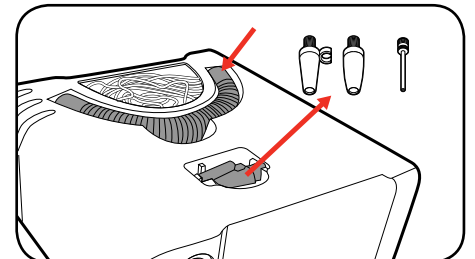

3 YEAR REPLACEMENT WARRANTY

OPERATION

2. SWITCHING ON & OFF

Connecting to a 12V outlet

- 1 Roll out the 12V socket from the base of the unit.

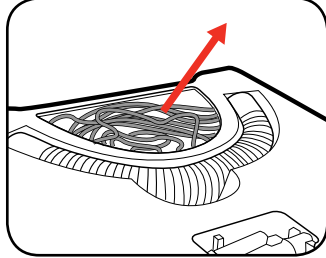

- 2 Connect the 12V socket to 12V DC outlet which can be found in your vehicle.

Check car outlet for sufficient power up to 120W.

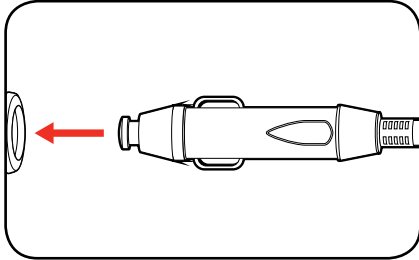

Switching On and Off

The compressor is fitted with a foot peddel on/off button to allow ease of use while holding adaptors and the item being inflated.

- 1 To start the air compressor press down the on/off button with your foot.

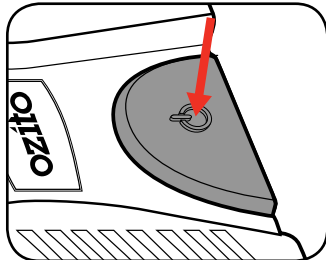

- 2 Release the on/off button to stop the compressor.

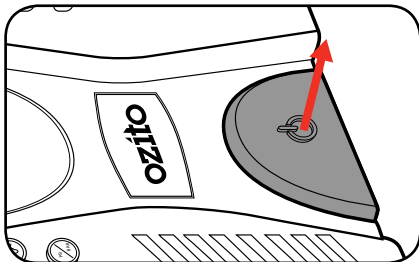

3. CONTROLS

Light Button

The compressor has a built-in LED light for ease of use at night or in a dark area.

- 1 To turn the LED light on, press the light button in.

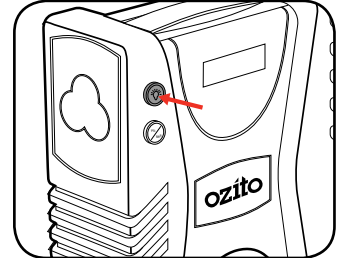

- 2 To turn the LED light off, press the light button again.

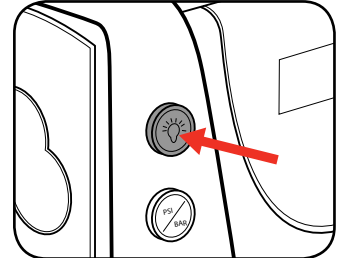

Note: The compressor must be connected to the power for the LED light to work.

PSI / BAR Button

The digital pressure reading can be switch between PSI and BAR to match the requirements on the item being inflated.

To identify the current pressure units, a light will be illuminated on the right side of the digital display.

- 1 To switch between the two pressure units, press the PSI / BAR button.

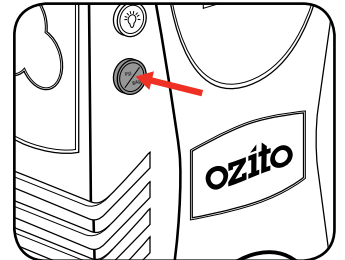

WARNING: COMPRESSED AIR CAN BE DANGEROUS. NEVER POINT THE OUTLET NOZZLE TOWARDS ANY PART OF YOUR BODY OR ANOTHER PERSON.

4. INFLATING



IMPORTANT: BEFORE CONNECTING OR DISCONNECTING ACCESSORIES, ALWAYS MAKE SURE THAT THE COMPRESSOR IS OFF.

- 1 Attach the required adaptor for the job.

NOTE: See the following pages to select the correct adaptors.

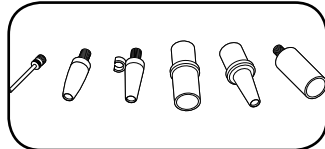

- 2 Connect the 12V socket to a power supply. The current pressure rating of the item you are inflating will now appear on the digital display.

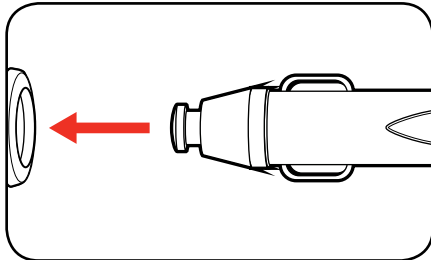

- 3 Press down the on/off switch to inflate the tyre to the recommended pressure is reached.

NOTE: The required pressure should be written on the item.

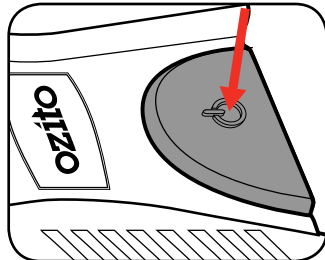

- 4 Once the pressure has reached the desired rating, remove the air hose and roll up into the side compartment.

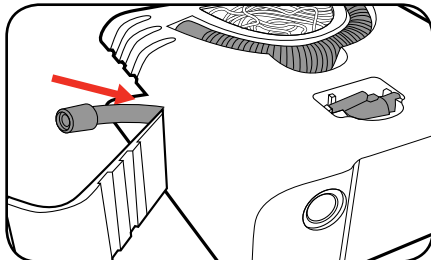

WARNING: AVOID INFLATING THE OBJECTS ABOVE THE RECOMMENDED INFLATION PRESSURE. THIS MAY LEAD TO DAMAGE AND/OR INJURIES.

5. INFLATING TYRES

- 1 Open the side compartment and roll out the air hose.

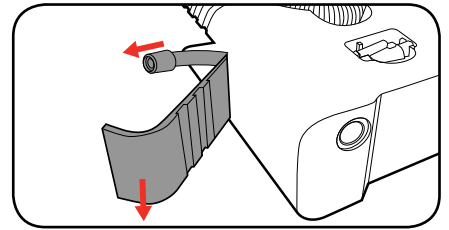

- 2 Unscrew the cap on the tyre air valve.

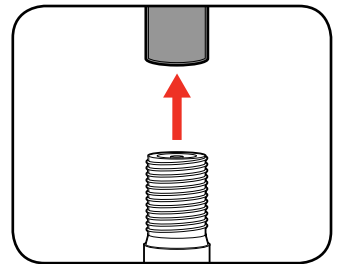

- 3 Attach the air hose by screwing the end of the hose in a clockwise direction.

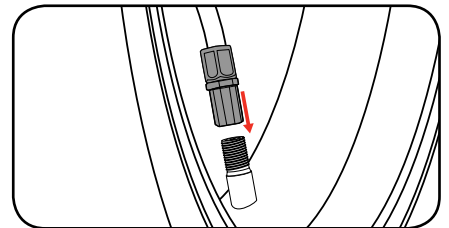

- 4 Follow steps 2 - 3 in section 3. "Inflating" to inflate the tyre.

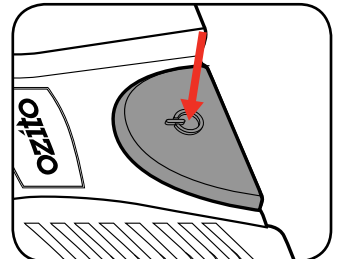

- 5 Unscrew the air hose and tighten plastic cap onto the tyre air valve.

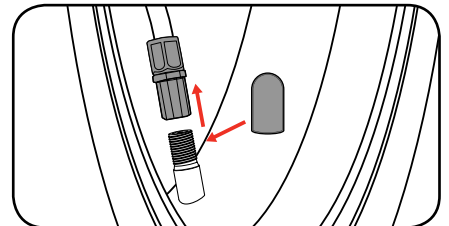

- 6 Place the adaptors and air hose back into their original compartments. Disconnect the 12V socket.

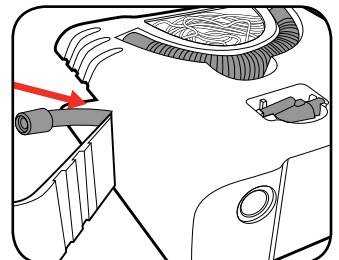

6. INFLATING SPORTING EQUIPMENT

- 1 Open the side compartment and roll out the air hose.

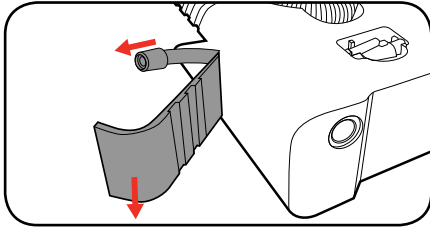

- 2 Remove the ball adaptor from the base of the compressor and screw onto the end of the air hose.

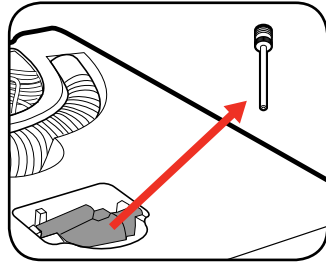

- 3 Insert the connected adaptor into the inflatable item.

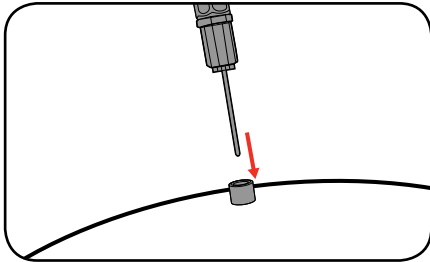

- 4 Follow steps 2 - 3 in section 3. "Inflating" to inflate the item.

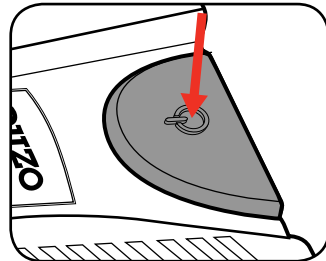

- 5 Remove the adaptor from the inflated item.

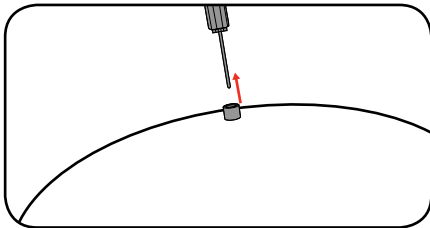

- 6 Place the adaptors and air hose back into their original compartments. Disconnect the 12V socket.

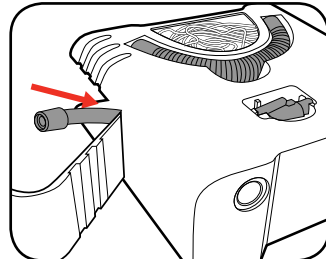

NOTE: The same process can be used to inflate balloons using the general purpose adaptors instead of the ball adaptor.

7. HIGH VOLUME APPLICATION

The air compressor is designed for quick and easy inflation of high air volume objects such as air mattresses, rafts and pool toys.

- 1 Remove the high volume hose from the base of the compressor and insert into the high volume air outlet.

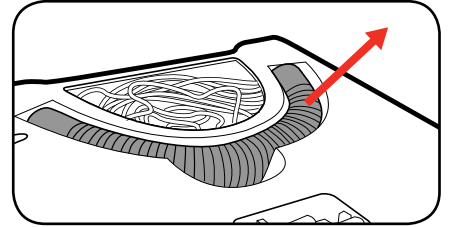

- 2 Attach the desired size adaptor from the side compartment.

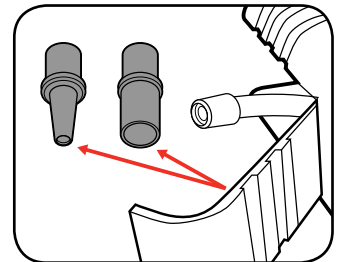

- 3 Insert the connected adaptor into the inflatable item.

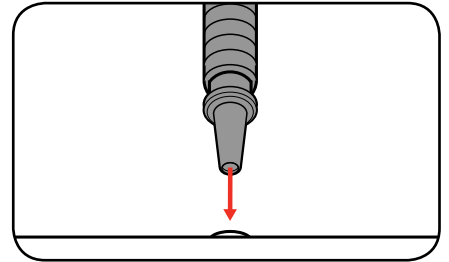

- 4 Follow steps 2 - 3 in section 3. "Inflating" to inflate the item.

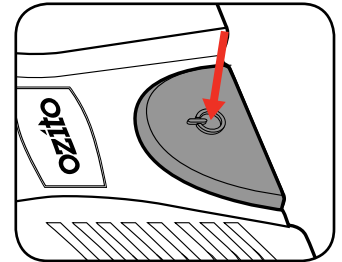

- 5 Remove the adaptor from the inflated item.

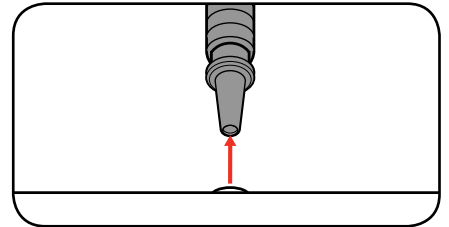

- 6 Place the adaptors and air hose back into their original compartments. Disconnect the 12V socket.

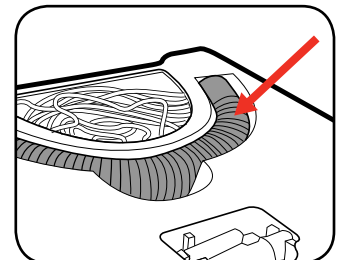

OPERATION

8. REPLACING FUSE



WARNING: ENSURE THE TOOL IS SWITCHED OFF AND DISCONNECTED FROM THE POWER SUPPLY BEFORE PERFORMING ANY OF THE FOLLOWING STEPS.

The 12V socket is fitted with a 10A fuse to protect the air compressor. If the compressor has stopped working and no lights or LEDs illuminate, the fuse may need to be replaced.

- 1 Unscrew the top of the 12V socket to expose the fuse.

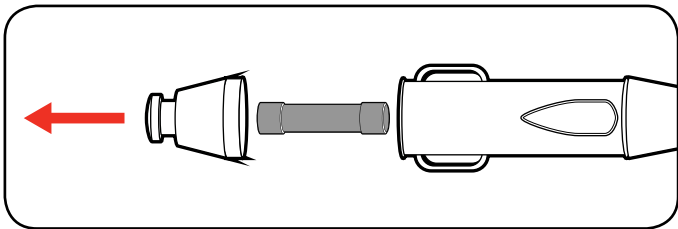

- 2 Replace the 10A fuse and screw the top back onto the 12V socket.

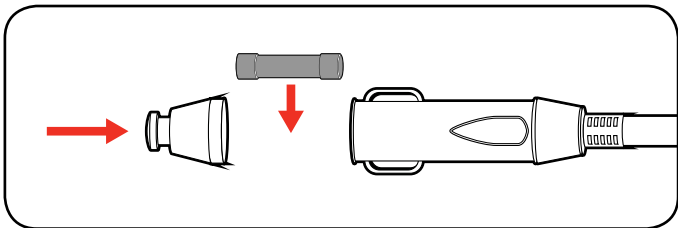

9. TROUBLESHOOTING

Problem	Cause	Solution
The compressor does not start	Compressor not connected to the power	Connect the 12V socket to a 12V DC outlet
	Insufficient supply voltage	Try another 12V outlet
	Fuse needs replacing	Replace Fuse
The compressor starts but there is no pressure	Loose hose connections	Check the compressed air hose and adaptor and replace if necessary
	The seals are damaged	Check the seals and have any damaged seals replaced by a service centre
LED light wont turn on	Compressor not connected to the power	Plug the 12V socket into a 12V outlet
High volume inflating does not completely inflate the item.	Not enough pressure for high volume inflation	Inflate using high pressure air hose not high volume

MAINTENANCE

10. CLEANING & MAINTENANCE



WARNING: BEFORE CLEANING YOUR COMPRESSOR OR CARRYING OUT ANY MAINTENANCE PROCEDURE, ENSURE THE COMPRESSOR IS SWITCHED OFF AND DISCONNECTED FROM THE POWER SUPPLY.



WARNING: WAIT UNTIL THE COMPRESSOR HAS COMPLETELY COOLED DOWN TO PREVENT BURNS.

Cleaning

- Keep the ventilation vents of the Compressor clean at all times, if possible, prevent foreign matter from entering the vents.
- After each use, blow air through the Compressor housing to ensure it is free from all dust particles which may build up. Build up of dust particles may cause the Compressor to overheat and fail.
- If the enclosure of the Compressor requires cleaning do not use solvents but a moist soft cloth only. Never let any liquid get inside the Compressor; never immerse any part of the Compressor into a liquid.

Note: Ozito Industries will not be responsible for any damage or injuries caused by the repair of the Compressor by an unauthorised person or by mishandling of the Compressor.

IMPORTANT: STORE THE COMPRESSOR ONLY IN A DRY LOCATION WHICH IS NOT ACCESSIBLE TO UNAUTHORISED PERSONS. ALWAYS STORE UPRIGHT, NEVER TILTED!

DESCRIPTION OF SYMBOLS

V	Volts	W	Watts
dc	Direct current	mA	Milliamperes
	Warning		Electrical Emissions Conformity (EMC)
	Read instruction manual		Indoor use only

CARING FOR THE ENVIRONMENT



Power tools that are no longer usable should not be disposed of with household waste but in an environmentally friendly way. Please recycle where facilities exist. Check with your local council authority for recycling advice.



Recycling packaging reduces the need for landfill and raw materials. Reuse of recycled material decreases pollution in the environment. Please recycle packaging where facilities exist. Check with your local council authority for recycling advice.

SPARE PARTS

Adaptors Kit

SPDMC1000-08K

Spare parts can be ordered from the Special Orders Desk at your local Bunnings Warehouse.

For further information, or any parts not listed here, visit

www.ozito.com.au or contact Ozito Customer Service:

Australia 1800 069 486

New Zealand 0508 069 486

E-mail: enquires@ozito.com.au

SPARE PARTS

Tool: 12V Digital Mini Compressor
Model No. DMC-1000

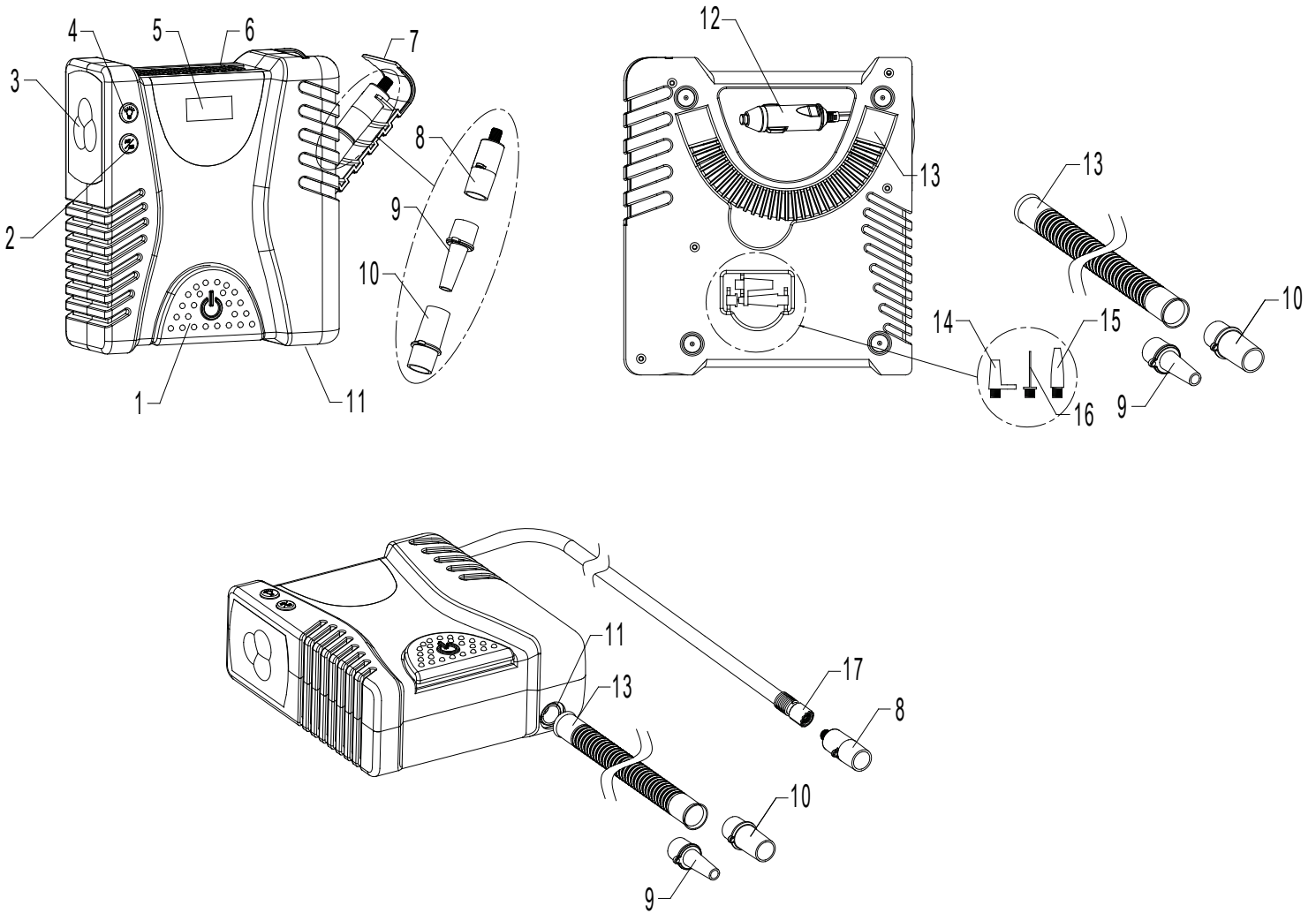

The following is a list of spare parts carried by Ozito.
Please contact Customer Service for any parts not listed.

Item No.	Description	Part No.
8-10	Adaptors Kit	SPDMC1000-08K

Item No.	Description	Part No.
----------	-------------	----------

How To Order

Available spare parts can be ordered through the Special Orders Desk at any Bunnings Warehouse. If you have any further questions, please contact Ozito Customer Service on:

Australia: 1800 069 486

New Zealand: 0508 069 486

enquiries@ozito.com.au

ELECTRICAL SAFETY



WARNING! When using mains-powered tools, basic safety precautions, including the following, should always be followed to reduce risk of fire, electric shock, personal injury and material damage.

Read the whole manual carefully and make sure you know how to switch the tool off in an emergency, before operating the tool.

Save these instructions and other documents supplied with this tool for future reference.

The electric motor has been designed for 12V only. Always check that the power supply corresponds to the

voltage on the rating plate.

If the supply cord is damaged, it must be replaced by an electrician or a power tool repairer in order to avoid a hazard.

GENERAL POWER TOOL SAFETY WARNINGS-PERSONAL SAFETY



WARNING! Read all safety warnings and all instructions. Failure to follow the warnings and instructions may result in electric shock, fire and/or serious injury. Save all warnings and instructions for future reference. The term “power tool” in the warnings refers to your mains-operated (corded) power tool or battery-operated (cordless) power tool.

1. Work area safety

- Keep work area clean and well lit.** Cluttered or dark areas invite accidents.
- Do not operate power tools in explosive atmospheres, such as in the presence of flammable liquids, gases or dust.** Power tools create sparks which may ignite the dust or fumes.
- Keep children and bystanders away while operating a power tool.** Distractions can cause you to lose control.

2. Electrical safety

- Power tool plugs must match the outlet. Never modify the plug in any way. Do not use any adapter plugs with earthed (grounded) power tools.** Unmodified plugs and matching outlets will reduce risk of electric shock.
- Avoid body contact with earthed or grounded surfaces, such as pipes, radiators, ranges and refrigerators.** There is an increased risk of electric shock if your body is earthed or grounded.
- Do not expose power tools to rain or wet conditions.** Water entering a power tool will increase the risk of electric shock.
- Do not abuse the cord. Never use the cord for carrying, pulling or unplugging the power tool. Keep cord away from heat, oil, sharp edges or moving parts.** Damaged or entangled cords increase the risk of electric shock.
- When operating a power tool outdoors, use an extension cord suitable for outdoor use.** Use of a cord suitable for outdoor use reduces the risk of electric shock.
- If operating a power tool in a damp location is unavoidable, use a residual current device (RCD) protected supply.** Use of an RCD reduces the risk of electric shock.

3. Personal safety

- Stay alert, watch what you are doing and use common sense when operating a power tool. Do not use a power tool while you are tired or under the influence of drugs, alcohol or medication.**
A moment of inattention while operating power tools may result in serious personal injury.
- Use personal protective equipment. Always wear eye protection.** Protective equipment such as dust mask, non-skid safety shoes, hard hat, or hearing protection used for appropriate conditions will reduce personal injuries.
- Prevent unintentional starting. Ensure the switch is in the off-position before connecting to power source and/or battery pack, picking up or carrying the tool.** Carrying power tools with your finger on the switch or energising power tools that have the switch on invites accidents.

- Remove any adjusting key or wrench before turning the power tool on.** A wrench or a key left attached to a rotating part of the power tool may result in personal injury.
- Do not overreach. Keep proper footing and balance at all times.** This enables better control of the power tool in unexpected situations.
- Dress properly. Do not wear loose clothing or jewellery. Keep your hair, clothing and gloves away from moving parts.** Loose clothes, jewellery or long hair can be caught in moving parts.
- If devices are provided for the connection of dust extraction and collection facilities, ensure these are connected and properly used.** Use of dust collection can reduce dust-related hazards.

4. Power tool use and care

- Do not force the power tool. Use the correct power tool for your application.** The correct power tool will do the job better and safer at the rate for which it was designed.
- Do not use the power tool if the switch does not turn it on and off.** Any power tool that cannot be controlled with the switch is dangerous and must be repaired.
- Disconnect the plug from the power source and/or the battery pack from the power tool before making any adjustments, changing accessories, or storing power tools.** Such preventive safety measures reduce the risk of starting the power tool accidentally.
- Store idle power tools out of the reach of children and do not allow persons unfamiliar with the power tool or these instructions to operate the power tool.** Power tools are dangerous in the hands of untrained users.
- Maintain power tools. Check for misalignment or binding of moving parts, breakage of parts and any other condition that may affect the power tool's operation. If damaged, have the power tool repaired before use.** Many accidents are caused by poorly maintained power tools.
- Keep cutting tools sharp and clean.** Properly maintained cutting tools with sharp cutting edges are less likely to bind and are easier to control.
- Use the power tool, accessories and tool bits etc. in accordance with these instructions, taking into account the working conditions and the work to be performed.** Use of the power tool for operations different from those intended could result in a hazardous situation.

5. Service

- Have your power tool serviced by a qualified repair person using only identical replacement parts.** This will ensure that the safety of the power tool is maintained.
- If the supply cord is damaged, it must be replaced by the manufacturer, its service agent or similarly qualified persons in order to avoid a hazard.**

AIR COMPRESSOR SAFETY WARNINGS

This appliance is not intended for use by young or infirm persons unless supervised by a responsible person to ensure that they can use the appliance safely. Young children should be supervised to ensure that they do not play with the appliance.

- When using the compressor, ensure you are parked in a safe, well lit location, off the road and with the hand brake engaged.
 - Ensure your personal safety is not at risk and never use the Digital Mini Compressor while the car is in motion.
 - Do not place the hose end against any part of your body when turned on, as this may infuse air into your blood stream putting your health at serious risk.
 - Do not make any alterations to this Compressor. Only use the adaptors supplied with this product.
 - Use this product only in accordance with operation instructions included in this manual.
 - If the vehicle fuse is blown, only replace with identical rated fuse.
 - Inspect each part before use. Do not use if bent, broken, melted, burnt or if the unit appears to be damaged.
 - Check the tyre pressure before inflating. Never exceed the suggested pressure of the item being inflated. If suggested pressure is exceeded, the item being inflated may burst.
 - Do not bend or pinch the air hose while the Compressor is in use.
 - It is not suggested that the Compressor work continuously for more than 10 minutes. If 10 minutes of use has been reached, turn it off and let it cool for 8 minutes before using again.
 - If the Compressor is making abnormal sounds or its temperature is quite high, turn off the power straight away and let it cool for at least 10 minutes before trying again. Improper use may result in damage of the Compressor.
 - Do not leave unattended and operating. Keep out of reach of children.
- Put the Compressor in a dry place if it is not in use for an extended period of time.
 - Keep the Compressor away from flammable liquid or gas. Do not allow the Compressor to become wet.
 - Never put the connector and adaptors into your mouth, ear or eye. They are not toys.

WARRANTY

IN ORDER TO MAKE A CLAIM UNDER THIS WARRANTY YOU MUST RETURN THE PRODUCT TO YOUR NEAREST BUNNINGS WAREHOUSE WITH YOUR BUNNINGS REGISTER RECEIPT. PRIOR TO RETURNING YOUR PRODUCT FOR WARRANTY PLEASE TELEPHONE OUR CUSTOMER SERVICE HELPLINE:

Australia 1800 069 486

New Zealand 0508 069 486

TO ENSURE A SPEEDY RESPONSE PLEASE HAVE THE MODEL NUMBER AND DATE OF PURCHASE AVAILABLE. A CUSTOMER SERVICE REPRESENTATIVE WILL TAKE YOUR CALL AND ANSWER ANY QUESTIONS YOU MAY HAVE RELATING TO THE WARRANTY POLICY OR PROCEDURE.

The benefits provided under this warranty are in addition to other rights and remedies which are available to you at law.

Our goods come with guarantees that cannot be excluded at law. You are entitled to a replacement or refund for a major failure and for compensation for any other reasonably foreseeable loss or damage. You are also entitled to have the goods repaired or replaced if the goods fail to be of acceptable quality and the failure does not amount to a major failure.

Generally you will be responsible for all costs associated with a claim under this warranty, however, where you have suffered any additional direct loss as a result of a defective product you may be able to claim such expenses by contacting our customer service helpline above.

3 YEAR REPLACEMENT WARRANTY

Your product is guaranteed for a period of **36 months from the original date of purchase**. If a product is defective it will be replaced in accordance with the terms of this warranty. Warranty excludes consumable parts, for example: valve adaptors and accessories.

WARNING

The following actions will result in the warranty being void.

- If the tool has been operated on a supply voltage other than that specified on the tool.
- If the tool shows signs of damage or defects caused by or resulting from abuse, accidents or alterations.
- Failure to perform maintenance as set out within the instruction manual.
- If the tool is disassembled or tampered with in any way.
- Professional, industrial or high frequency use.