

# cowdroy



SPECIAL  
ORDERS

## CUSTOM BUILT BARRIER DOORS



Available at  
**BUNNINGS**  
warehouse

# 6 EASY STEPS TO SELECTING YOUR BARRIER DOOR

## HERE IS HOW YOU ORDER YOUR CUSTOMER BUILT BARRIER DOOR

### ① BARRIER DOORS

Below is the range of Barrier Door styles.



**SUPERIOR**

Custom Maximum Size 2500mm x 1300mm



**BIRCHGROVE**

Maximum Size 2512mm x 1365mm



**FEDERATION**

Maximum Size 2230mm x 920mm



**PADDINGTON**

Maximum Size 2230mm x 920mm



**HARRINGTON**

Maximum Size 2230mm x 920mm



**BALMAIN**

Maximum Size 2230mm x 920mm

### ② CHOOSE COLOURS

Door Finish	Default Lock Finish	Default Door Closer Finish (Optional)
	<input type="radio"/> White	<input type="radio"/> White
	<input type="radio"/> White Birch	<input type="radio"/> White Birch
	<input type="radio"/> Primrose	<input type="radio"/> Primrose
	<input type="radio"/> Black	<input type="radio"/> Black
	<input type="radio"/> Stone Beige	<input type="radio"/> Stone Beige
	<input type="radio"/> Black	<input type="radio"/> Black
	<input type="radio"/> Black	<input type="radio"/> Black
	<input type="radio"/> Black	<input type="radio"/> Black
	<input type="radio"/> Black	<input type="radio"/> Black
	<input type="radio"/> Black	<input type="radio"/> APO Grey
	<input type="radio"/> Black	<input type="radio"/> Black
	<input type="radio"/> Black	<input type="radio"/> Black
	<input type="radio"/> Black	<input type="radio"/> Black
	<input type="radio"/> Black	<input type="radio"/> Black
	<input type="radio"/> Black	<input type="radio"/> Black
	<input type="radio"/> Black	<input type="radio"/> Black
	<input type="radio"/> Bronze	<input type="radio"/> Bronze
	<input type="radio"/> Brown	<input type="radio"/> Brown
	<input type="radio"/> Woodland Grey	<input type="radio"/> Woodland Grey
	<input type="radio"/> Hawthorn Green	<input type="radio"/> Hawthorn Green
	<input type="radio"/> Black	<input type="radio"/> Black

Choose any combination of door lock & closer from the above colour range.

# MEASURE & RECORD YOUR DETAILS

## ③ DOOR OPENING MEASUREMENTS

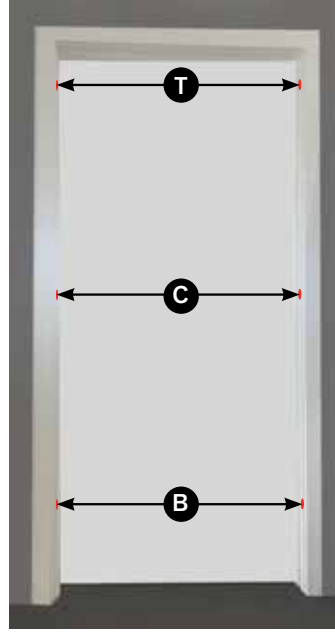
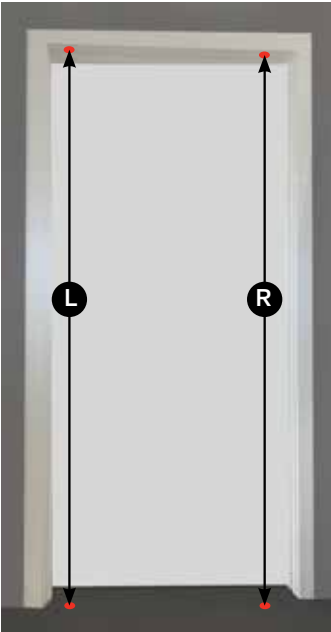

Always measure on the other side of the jamb from which the entry door sits.

### HEIGHT

<b>L</b>	mm
<b>R</b>	mm

### WIDTH

<b>T</b>	mm	<b>B</b>	mm
<b>C</b>	mm		

## ④ LOCK/HANDLE

Check the space between your existing door lock and the outside face of your jamb. *The gap required to ensure your new barrier door fits is minimum 20mm.*

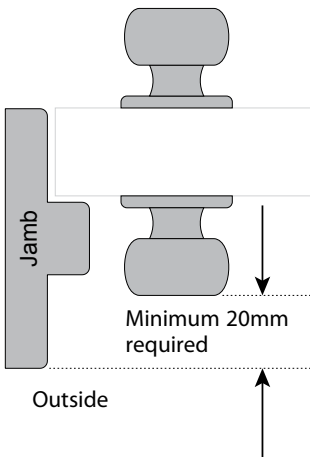

## ⑤ HANDLE SIDE

From the outside looking in, choose your handle side. *Usually the same side as your existing door.*



L/H Side



R/H Side

## ⑥ HANDLE HEIGHT

How high would you like your handle? Enter your distance from the sill up to the centre of the handle lever.

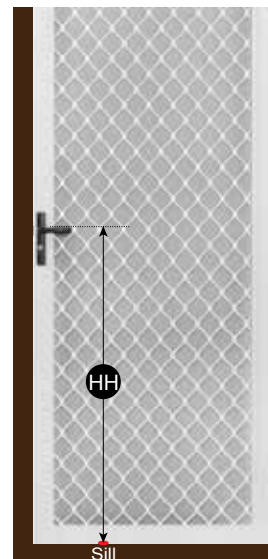

**IMPORTANT**  
Ensure the height of the handle of your new barrier door will not collide with the handle of your existing door when closed.

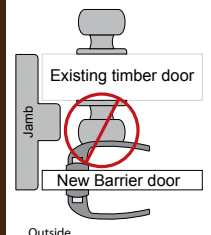

Outside

<b>HH</b>	mm
-----------	----

# BARRIER DOOR ORDER FORM



## STANDARD INCLUSIONS

I/N - Item No

Using the guide to the left complete this form to order your new barrier door.  
Note: Take extra care with your measurements as your door cannot be altered once it has been made.

### 1. Select door type What type of door would you like?

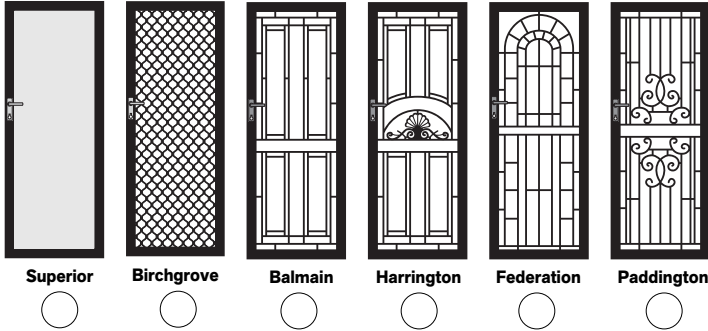

2029984 All doors up to 930mm W I/N - 2029985 Doors wider than 930mm	I/N - 2029988 For all doors sizes	I/N - 2029987 For all doors sizes	I/N - 2029986 For all doors sizes	I/N - 2029989 For all doors sizes	I/N - 2036319 For all doors sizes
---	--------------------------------------	--------------------------------------	--------------------------------------	--------------------------------------	--------------------------------------

### 2. What colour would you like your doors from the options to the left.

### 3. Enter your door opening sizes in column A OR your make-to-size in column B

	<b>A</b> Door Opening		<b>B</b> Doors Make to Size
<b>L</b>	mm	<b>-10mm</b>	mm
<b>R</b>	mm	<b>-10mm</b>	mm
<b>T</b>	mm	<b>-8mm</b>	mm
<b>C</b>	mm	<b>-8mm</b>	mm
<b>B</b>	mm	<b>-8mm</b>	mm

### 4. Select your handle colour. Available colours shown below

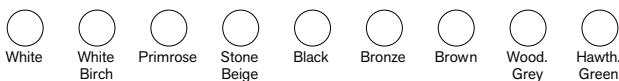

### 5. Select your handle side. (From the outside looking inwards)

LEFT  RIGHT

### 6. Enter your handle height. (From sill to centre of handle lever)

HH  mm

## OPTIONAL ACCESSORIES

I/N - Item No.

Optional extras sold separately

**A. Extra security**  I/N - 2029995  
*Add Triple Lock*

**B. DVA Mesh/Privacy**  I/N - 2029996

Select colour  
(Available colours shown below)



*Not available for Superior Doors*

**C. Superior Steel Mesh**  I/N - 2029998

*Available on all doors. Included as standard for Superior Doors*

**D. Paw-Proof Pet Mesh**  I/N - 2029997

*Not available for Superior Door*

**E. Perspex Pet Door**  SMALL I/N - 2029990

(Available for Superior Doors Only)  MEDIUM I/N - 2029991

HINGE SIDE  HANDLE SIDE   LARGE I/N - 2029992

**F. Door Closer**  I/N - 2029994

Select colour (Available colours shown below)

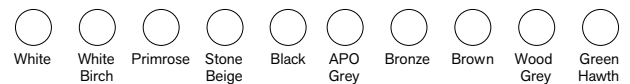

**G. Bug Seal**  I/N - 2029993

**H. Take your completed form to the Special Orders Desk at your local Bunnings Warehouse to complete your order.**  
I can confirm that all the information provided here is accurate.

CSO Number	
Customer name	
Customer contact No.	
Bunnings store	
Bunnings store No.	
Team member name	
Date	
Customer Signature	

Please email your completed form to:  
cowdroy@cowdroy.com.au



(NOTE: For Triple Lock option - fittings will be located at an equal distance above and below this nominated handle height)

The Cowdroy Barrier Door range offers a selection of standard and custom built quality screen doors in a range of designs and colours that will enhance and compliment the look of your home.

All doors come with the following:

- Heavy duty extruded aluminium frame
- Double cylinder lock with deadlocking and privacy functions
- 2 hinges per door
- 21 standard powder coat colours to choose from
- A range of popular optional accessories
- Custom made to your sizes
- 5 year replacement warranty
- Australian made

## SUPERIOR DOOR

Features a high quality and impact resistant #316 grade woven stainless steel mesh fitted inside the frame by way of a double locking wedge and an acrylic adhesive.

The "Superior" door combines strength and quality with an unobtrusive view.

## BIRCHGROVE

Popular diamond grille door made to order.

## PADDINGTON, FEDERATION, HARRINGTON, BALMAIN

Features a decorative cast aluminium panel fitted within the frame and finished with a quality fibreglass mesh.

There are 4 highly popular panel inserts available in the range, each of which are finished in the same durable powdercoat as the frame.

This range combines elegance with quality and will give your home a new look.

## BARRIER DOOR OPTIONAL EXTRAS

### ✓ TRIPLE LOCK

Upgrade your lock option to an Austral EKIT triple lock for increased locking security.

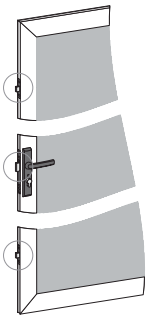

### ✓ DOOR CLOSER

Add a pneumatic door closer to automatically return your door to its closed position.

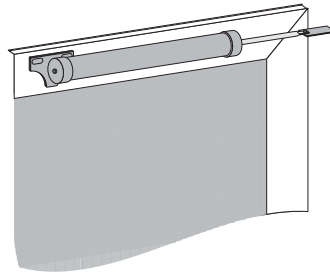

### ✓ PET DOORS\* \*Suitable for "Superior" door only

Pet doors are ideal for those with indoor pets.  
Available in 3 sizes Small (190x240mm), Medium (255x305mm) & Large (260x400mm)



### ✓ BUG SEAL

Consider a bug seal to help keep out those unwanted pests.  
All bug seals are finished in the same colour as your door.

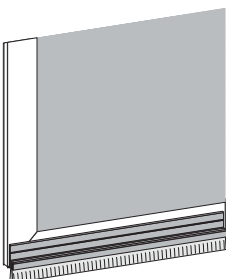

### ✓ DVA MESH

For increased privacy upgrade your mesh to reduced visibility, light dependant DVA mesh.

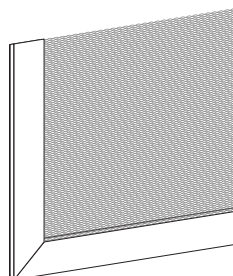

### ✓ PET MESH

Protect your pet by upgrading your mesh to a pet-friendly soft mesh.

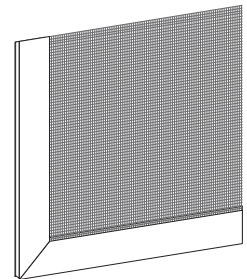



# 3 Easy Steps to a Custom Made Barrier Door



**Follow the simple instructions to help make your selection.**  
**Measure carefully**, check twice and write clearly with a black ink pen.



**Take your completed form to the Special Orders desk to place your order.**

Ensure that you have correctly filled out all the required fields and that you have nominated your door style, colour and desired options, as Cowdroy will not accept liability for incorrect measurement.



**Your Special Order will be delivered to store for customer pick up.**

Delivery is 10 working days for east coast metropolitan areas, 10 - 15 working days for east coast regional areas and up to 20 working days for all other areas in Australia.

Warranty information can be found at [www.cowdroy.com.au](http://www.cowdroy.com.au)



**More Choice**  
From Special Orders



**Order through the  
SPECIAL ORDERS Desk**