



Product Overview

July 2012



James Hardie

A smarter way to build

Products and where to use them

Product	Application																
	Bathroom constructions	Bracing	Columns	Structural flooring	Cavity construction	Commercial facades	Decking	Decorative	Eaves	Soffits	External cladding	Fencing	Fire and acoustically rated wall	Internal lining	Jointing compound	Thermal break	Underlays
Artista® column			✓					✓									
ComTex® facade panel and fixing system					✓	✓					✓		✓				
EasyLap™ panel		✓									✓		✓				
ExoTec® facade panel and fixing system					✓	✓				✓	✓		✓				
HardieBrace™ sheet		✓															
HardieBreak™ thermal strip					✓												✓
HardieFence™ EasyLock® system												✓					
HardieFlex™ sheet		✓							✓	✓	✓		✓				
HardieGroove™ lining									✓	✓			✓	✓			
HardiePanel™ compressed sheet	✓			✓			✓										
HardiePlank™ weatherboard		✓							✓	✓	✓		✓				
HardieScreen™ lattice								✓									
HardieTex™ system		✓									✓		✓				
James Hardie™ Base Coat																✓	
James Hardie™ Top Coat																✓	
James Hardie™ ceramic tile underlay	✓																✓
James Hardie™ vinyl and cork underlay	✓																✓
PanelClad® sheet		✓							✓	✓	✓		✓				
PineRidge® lining		✓												✓			
PrimeLine® weatherboard									✓	✓	✓		✓				
Versilux® lining		✓							✓	✓			✓	✓			
Villaboard® lining	✓	✓							✓	✓			✓	✓			

● Introduction	
Working safely	2
Environmental impact	3
● External cladding	
HardieFlex™ sheet	4
HardieTex™ system	6
EasyLap™ panel	8
PrimeLine® weatherboard	10
HardiePlank™ weatherboard	14
PanelClad® sheet	18
● Facade systems	
ExoTec® facade panel and fixing system	20
ComTex® facade panel and fixing system	22
● Eaves	
HardieFlex™ sheet in eaves lining sizes	24
● Internal lining	
Villaboard® lining	26
James Hardie™ Base Coat	28
James Hardie™ Top Coat	28
HardieGroove™ lining	29
Versilux® lining	30
PineRidge® lining	32
● Flooring	
HardiePanel™ compressed sheet	34
● Underlays	
James Hardie™ ceramic tile underlay	36
James Hardie™ vinyl and cork underlay	38
● Bracing	
HardieBrace™ sheet	40
● Fencing	
HardieFence™ EasyLock® system	42
● HardieSmart™ Components	
HardieBreak™ thermal strip	44
● Decorative products	
Artista® column	47
HardieScreen™ lattice	50

Working safely

During installation or handling:

1. Work in outdoor areas with ample ventilation.
2. Minimise dust when cutting by using either a 'score and snap' knife, fibre cement shears or, where this is not feasible, use a HardieBlade™ Saw Blade and dust-reducing circular saw attached to a HEPA vacuum.
3. Warn others in the immediate area to avoid breathing dust.
4. Wear a properly fitted, approved dust mask or respirator (for example, P1 or P2) in accordance with applicable government regulations and manufacturer instructions to further limit respirable silica exposures. When cleaning up, use HEPA vacuums or wet clean-up methods. Never dry sweep.

Warning – Do not breathe dust and cut only in a well ventilated area.

Failure to adhere to our warnings, material safety data sheets and installation instructions may lead to serious personal injury or death.

For further information, refer to our installation instructions, Material Safety Data Sheets and our guide to safe handling at: www.jameshardie.com.au or www.scyon.com.au.



James Hardie® products contain sand, a source of respirable crystalline silica, which is considered by some international authorities to be a cause of cancer from some occupational sources.

Breathing excessive amounts of respirable silica dust can also cause a disabling and potentially fatal lung disease called silicosis, and has been linked with other diseases. Some studies suggest smoking may increase these risks.

Environmental impact



James Hardie is a longstanding industry innovator, and works consistently to improve the sustainability of its products and manufacturing operations. The environmental impact of James Hardie® products can be viewed from the following perspectives:

James Hardie products have undergone independent third party Ecological, Health and Technical evaluation for life cycle impacts and relevance to the GreenRate Green Building Scheme Pre-Assessment. Enhanced Content Product listings for all James Hardie products can be found on Ecospecifier's eco-preferable material database at www.ecospecifier.org.

What's the impact of manufacturing James Hardie products?

James Hardie products are made from benign raw materials low in toxicity:

- Cellulose fibre – unbleached pine wood pulp from sustainable plantation timbers (*Pinus radiata*)
- Ordinary Portland cement
- Ground sand*
- Small amounts of additives as required for specific product properties
- Water.

James Hardie products are low in embodied energy relative to many other building products like masonry and concrete.

What's the impact of construction that uses James Hardie products?

James Hardie products are easy to incorporate into practical building systems that touch the earth lightly.

What's the impact of using James Hardie products, over the life of a building?

James Hardie products are very durable and low maintenance which helps create buildings low in lifetime energy consumption.

What's the impact on people, living and working in buildings made from James Hardie products?

Used in the right design, James Hardie products can be used to create energy efficient and thermally comfortable buildings in any Australian climate. James Hardie products are low in volatile organic compounds (VOCs).

* Please read the *Best Practice Guide: Working safely with Fibre Cement Products* which is available at www.jameshardie.com.au/bestpractice.

HardieFlex™ sheet



What is it?

A smooth, flat sheet that is painted on-site to create a flat panel look.

Where do you use it?

As an external wall cladding, eaves or soffit lining in residential single and medium-density homes, including alterations and additions, where a flat panel look is required. Ideal for full wrap or composite construction designs on either timber or light gauge steel framed homes.

What are the key benefits?

AFFORDABILITY. Fast installation involving only two trades helps make HardieFlex sheet one of the most cost-effective cladding solutions available.

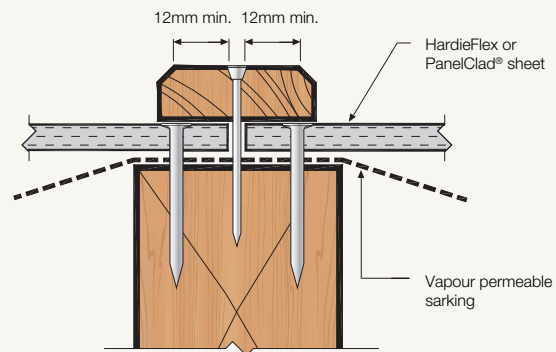
DESIGN FLEXIBILITY. It's easy to achieve a range of looks with HardieFlex sheet using battens or Scyon™ Axent™ trim vertically over sheet joints, as bold or subtle highlights over their smooth, flat surface.

FAST INSTALLATION. HardieFlex sheet is lightweight and its square edges, together with the wide range of James Hardie™ accessories, make it easy and fast to install by tradespeople, owner-builders and renovators.

VERSATILITY. 6mm HardieFlex base sheet can also be used as bracing.*

SECURITY. HardieFlex sheet is resistant to damage from termites, rot and fire.** A 10-year product warranty gives peace of mind.

Figure 1 Timber batten joint



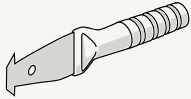
Note All dimensions and masses provided are approximate only and subject to manufacturing tolerances. Masses are based on equilibrium moisture content of product.

* When installed in accordance with James Hardie's *Structural Bracing Design Guide*.

** When installed and maintained correctly and to the extent set out in James Hardie's published literature current at the time of installation.

HardieFlex™ sheet

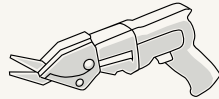
What are the accessories?



305576 James Hardie™ Score and Snap Knife

A tungsten tipped knife for scoring fibre cement sheets.

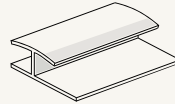
Selling unit: 20 per box



300653 James Hardie™ Fibreshers

Electric tool for cutting fibre cement sheets.

Selling unit: 1 each

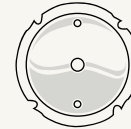


305538/305541/305546 James Hardie™ PVC Straight Jointer

A PVC extrusion used to join sheets.

Selling unit: 25 per pack

Length: 2,400mm x 4.5mm
3,000mm x 4.5mm
3,000mm x 6.0mm

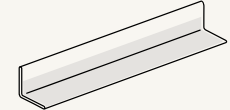


300660/303375 HardieBlade™ Saw Blade

A poly-diamond blade for fast and clean cutting of James Hardie fibre cement

Selling unit: 1 Each

Diameter: 185mm/254mm



305554 James Hardie™ 45x45mm PVC Corner Angle Mould

A PVC extrusion used to finish internal and external corners.

Selling unit: 25 per pack

Length: 3,000mm

What are the sizes?

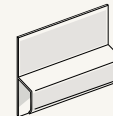
Product code	Length (mm)	Width (mm)	Thickness (mm)	Mass (kg/m ²)
400195	1,800	900	4.5	7.7
400189	1,800	1,200	4.5	7.7
400188	2,100	1,200	4.5	7.7
400193	2,400	900	4.5	7.7
400186	2,400	1,200	4.5	7.7
400192	2,700	900	4.5	7.7
400184	2,700	1,200	4.5	7.7
400191	3,000	900	4.5	7.7
400182	3,000	1,200	4.5	7.7
400173	1,800	1,200	6.0	10
400175	2,400	900	6.0	10
400171	2,400	1,200	6.0	10
400169	2,700	1,200	6.0	10
401970*	3,000	900	6.0	10
400167	3,000	1,200	6.0	10

Selling units per pack:

4.5mm – 60 sheets, 30 sheets per half pack;

6.0mm – 30 sheets, 15 sheets per half pack

* Available in QLD only.

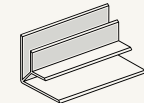


305552 James Hardie™ PVC Internal Corner Angle for 6mm thick sheets

A PVC extrusion for multicourse fixing of 6mm thick sheets.

Selling unit: 25 per pack

Length: 3,000mm

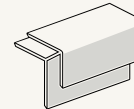


305545 James Hardie™ PVC External Corner Angle for 6mm thick sheets

A PVC extrusion, to be used with 6mm thick sheets at internal corner junctions to conceal the sheet edge.

Selling units: 25 per pack

Length: 3,000mm

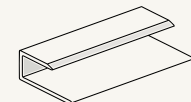


305544 James Hardie™ PVC External Corner Angle for 6mm thick sheets

A PVC extrusion, to be used with 6mm thick sheets at external corner junctions to conceal the sheet edge.

Selling units: 25 per pack

Length: 3,000mm



305542/305543 James Hardie™ PVC Cap Mould

A PVC extrusion used to finish sheet edges.

Selling unit: 25 per pack

Length: 3,000mm x 4.5mm
3,000mm x 6.0mm

HardieTex™ system



What is it?

A strong, pre-primed base sheet that is finished on-site with a specialised texture coat system,* which includes joint reinforcement. HardieTex system is the original way to create a decorative, monolithic rendered look without the need for masonry.

Where do you use it?

As an external cladding in residential homes, including alterations and additions, where a lightweight system with a monolithic rendered look is required. Ideal for full wrap or composite construction designs on either timber or light gauge steel framed homes.

What are the key benefits?

AFFORDABILITY. When it comes to double storeys in particular, two big cost-drivers are scaffolding and structural beams. Using pre-primed, lightweight HardieTex base sheet instead of rendered masonry can help significantly reduce those costs.

DESIGN FLEXIBILITY. The seamless, monolithic look created with HardieTex system makes it a perfect foil for a special design accent. A variety of textures and colours can be achieved with a site-applied texture system, making HardieTex base sheet the perfect canvas for a diverse mix of colours and textures.

VERSATILITY. HardieTex base sheet can also be used as bracing.**

SECURITY. Manufactured by James Hardie for more than 20 years, HardieTex base sheet is the 'original' fibre cement cladding designed for the application of acrylic render coating. HardieTex base sheet is resistant to damage from termites, rot and fire† and its 10-year product warranty gives peace of mind.

What are the sizes?

Product code	Length (mm)	Width (mm)	Thickness (mm)	Mass (kg/m ²)
400293	2,440	900	7.5	12.5
401651	2,440	1,200	7.5	12.5
400295	2,725	900	7.5	12.5
400294	2,725	1,200	7.5	12.5
400296	3,000	900	7.5	12.5
400291	3,000	1,200	7.5	12.5

Selling units per pack: 30 sheets or each

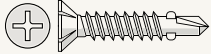
Note All dimensions and masses provided are approximate only and subject to manufacturing tolerances. Masses are based on equilibrium moisture content of product.

* To be applied in accordance with the texture coat manufacturer's guidelines. ** When installed in accordance with James Hardie's *Structural Bracing Design Guide*.

† When installed and maintained correctly and to the extent set out in James Hardie's published literature current at the time of installation.

HardieTex™ system

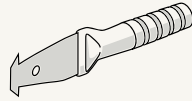
What are the accessories?



**305532 HardieDrive™
Screws 32mm long**

A class 3 finish self-tapping wing-tipped screw for fastening to 0.8mm to 1.6mm BTM steel frames.

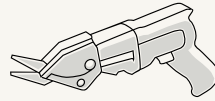
Selling unit: 500 per box



**305576 James Hardie™
Score and Snap Knife**

A tungsten tipped knife for scoring fibre cement sheets.

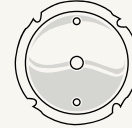
Selling unit: 20 per box



**300653 James Hardie™
Fibrshears**

Electric tool for cutting fibre cement sheets.

Selling unit: 1 each

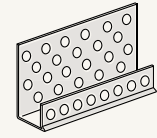


**300660/303375
HardieBlade™ Saw Blade**

A poly-diamond blade for fast and clean cutting of James Hardie fibre cement.

Selling unit: 1 Each

Diameter: 185mm/254mm



**305568 James Hardie™
7.5mm PVC Starter Strip**

A perforated PVC extrusion, used with HardieTex™ sheet to provide a straight edge to finish the texture coating or used with PrimeLine® Newport or Summit weatherboard to secure the bottom row at the correct angle.

Selling unit: 25 per pack
Length: 3,000mm



**305534 James Hardie™
Joint Sealant***

A general purpose, paintable, exterior grade polyurethane joint sealant.

Selling unit: 20 per box
300ml cartridge

* Not to be used in fire applications.

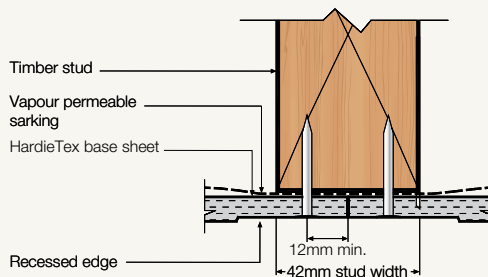


**305569 HardieTex™
7.5mm PVC Z Flashing**

A PVC extrusion for use with HardieTex™ system to provide an alternative detail option at horizontal control joints.

Selling unit: 25 per pack
Length: 3,000mm

Figure 2 Single timber stud



EasyLap™ panel



What is it?

A strong fibre-cement base sheet with a shiplap vertical joint, it's finished with a site-applied roll-on textured acrylic paint to create a rendered look with a subtle vertical joint. Lightweight but durable, EasyLap™ panel is the most easily installed and cost-effective broadwall, textured-cladding solution.

Where do you use it?

As an external wall cladding in residential single and medium-density homes, including alterations and additions, where a uniform broadwall cladding is required. Ideal for full wrap or composite construction designs on either timber or light gauge steel framed homes.

What are the key benefits?

AFFORDABILITY. The roller-applied acrylic texture paint finish eliminates the need for specialised applicators – only two trades (your carpenter and painter) are needed for the complete installation and there's a clean, dry worksite to boot. Lightweight construction means scaffolds are typically up for less time when compared to masonry construction.

DESIGN FLEXIBILITY. The joint design gives a subtle vertical shadow line while allowing you to create large painted expanses.

FAST INSTALLATION. The exposed vertical shiplap joint enables fast installation because it eliminates the need for a vertical set joint and control joint. Added to this, the large sheets with off-the-shelf corner finishing details give fast broadwall coverage.

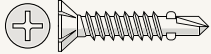
SUSTAINABILITY. When EasyLap panel is used in conjunction with cavity construction and the right insulation (in accordance with James Hardie's *Wall System Thermal Performance Total R-Values Technical Supplement*), an R-value of up to 3.4 can be achieved for the wall.

SECURITY. Made from thick and solid 8.5mm fibre cement, EasyLap panel is resistant to damage from termites, rot and fire.* A 10-year product warranty gives peace of mind.

Note All dimensions and masses provided are approximate only and subject to manufacturing tolerances. Masses are based on equilibrium moisture content of product.
* When installed and maintained correctly and to the extent set out in James Hardie's published literature current at the time of installation.

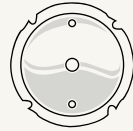
EasyLap™ panel

What are the accessories?



305532 HardieDrive™ Screw 32mm long

A class 3 finish self-tapping wing-tipped screw for fastening to 0.8mm to 1.6mm BTM steel frames.
Selling unit: 500 per box



300660/303375 HardieBlade™ Saw Blade

A poly-diamond blade for fast and clean cutting of James Hardie fibre cement
Selling unit: 1 Each
Diameter: 185mm/254mm



305534 James Hardie™ Joint Sealant*

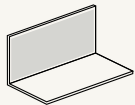
A general purpose, paintable, exterior grade polyurethane joint sealant.
Selling unit: 20 per box
300ml cartridge

* Not to be used in fire applications.



304560 James Hardie™ 50mm wide Foam Back Sealing Tape

A self-adhesive foam tape to help improve water tightness with EasyLap™ panel. It is applied under sheet joins to the vapour permeable membrane along the stud face.
Selling unit: 1 Each
25 metres long roll



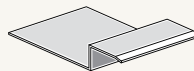
305564 James Hardie™ 75x75mm Colorbond® Corner Flashing

A Colorbond® corner flashing for use behind cladding at internal and external corners.
Selling unit: 5 per pack
Length: 3,000mm



Roll-on texture paint**

EasyLap™ panels are designed to have a rolled-on texture coat. Refer to Wattyl, Dulux, Taubmans or equivalent product manufacturer, see section 6 of the EasyLap panel installation guide for more information.



305614 James Hardie™ 9mm Aluminium Horizontal h Joinder

A ready to paint aluminium joinder, used to join the James Hardie™ 9mm Aluminium Horizontal h Flashing.
Selling unit: 10 per pack

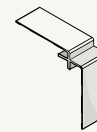
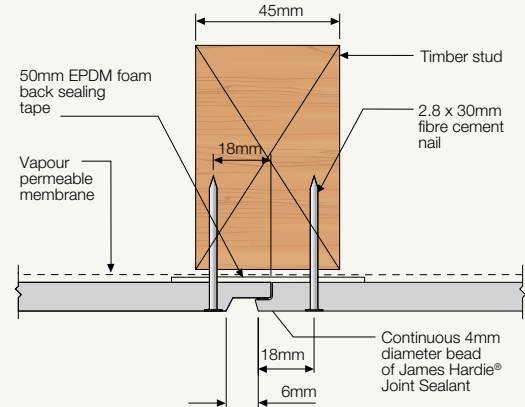
What are the sizes?

Pre-primed sheet with a shiplap edge joint along the two long edges.
Sheet weighs approximately 12kg/m² in equilibrium.

Product code	Length (mm)	Width (mm)	Thickness (mm)	Mass (kg/m ²)
404186	3,000	900	8.5	12.6
404184	2,440	1,200	8.5	12.6
404185	3,000	1,200	8.5	12.6

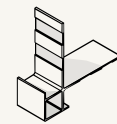


Figure 3 Fibre cement nail fixing



305520 James Hardie™ 9mm Aluminium Internal Corner

A ready to paint aluminium extrusion, to be used with EasyLap™ panel, at internal corner junctions to conceal the board edge.
Selling unit: 5 per pack
Length: 3,000mm



305521 James Hardie™ 9mm Aluminium External Corner

A ready to paint aluminium extrusion, to be used with EasyLap™ panel at external corner junctions to conceal the board edge.
Selling unit: 5 per pack
Length: 3,000mm

** James Hardie recommends the following products for use in conjunction with the EasyLap panels. James Hardie does not supply these products. Please contact the component manufacturer for information on their warranties and further information on their products.

PrimeLine® weatherboard



PrimeLine® Newport weatherboard.

What is it?

A pre-primed, site-painted weatherboard, available in a range of profiles from contemporary to traditional. The range includes the following weatherboards:

PrimeLine® Summit. A slender, beaded-edge weatherboard with a strong lap line. Compatible with the HardieLock™ fixing system.

PrimeLine® Heritage. A double-width weatherboard with rebated edges to create shadow lines

PrimeLine® Newport. A smooth, narrow weatherboard. Compatible with the HardieLock™ fixing system

PrimeLine® Chamfer. A double-width weatherboard with clean lines to create a shadow effect.

Where do you use it?

As an external cladding in residential single and medium-density homes, including alterations and additions, where a traditional or contemporary weatherboard look is required. Ideal for full wrap or composite construction designs on either timber or light gauge steel framed homes.

What are the key benefits?

AFFORDABILITY. PrimeLine weatherboard is pre-primed with a milled finish, making it easy to paint, and reducing the finishing time and cost.*

DESIGN FLEXIBILITY. A wide variety of looks, from contemporary to traditional, can be achieved with the varying profiles in the range.

FAST INSTALLATION. Both the Summit and Newport profiles come with the HardieLock™ fixing system, which minimises the time needed to set out the boards. The PVC HardieLock spline that runs along the back of these profiles fits neatly over the lower board, locking it securely into position. Added to this, it enables off-stud joining, which minimises wastage and allows fasteners to be concealed, which enhances the finished look. Chamfer and Heritage profiles come in a double-width board, which allows faster wall coverage, and off-stud joining is possible with the PrimeLine® Universal Off Stud Joint Clip accessory.

SECURITY. PrimeLine weatherboard is resistant to damage from termites, rot and fire.** A 25-year product warranty gives peace of mind. Added to this, both Taubmans and Wattyl provide a 15-year paint warranty on selected paints when applied to PrimeLine weatherboard.

Note All dimensions and masses provided are approximate only and subject to manufacturing tolerances. Masses are based on equilibrium moisture content of product.

* Always refer to the paint manufacturer's guidelines.

** When installed and maintained correctly and to the extent set out in James Hardie's published literature current at the time of installation.

PrimeLine® weatherboard

What are the sizes?

Product code	Profile	Length (mm)	Width (mm)	Thickness (mm)	Mass (kg/lm)
400380	Summit*	4,200	230	9	3.3
400153	Heritage**	4,200	300	9	4.3
400319	Newport*	4,200	170	9	2.5
400103	Chamfer**	4,200	300	9	4.3

Selling units per pack:

Summit: 120 lengths, Heritage: 90 lengths, Newport: 120 lengths, Chamfer: 90 lengths

*HardieLock® fixing system. ** Double board profile.

Figure 4 Installing first PrimeLine® Summit or Newport weatherboard

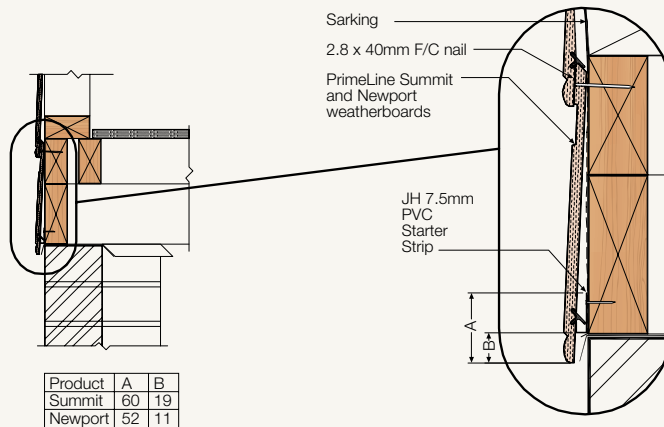
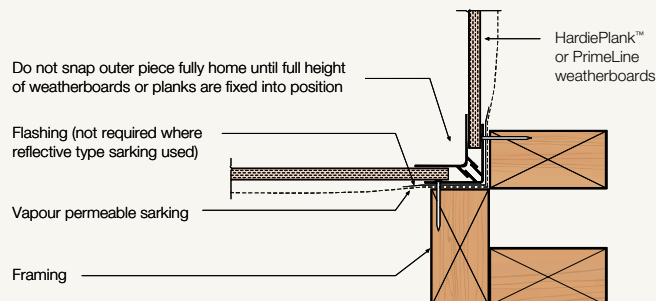


Figure 5 Internal corner



PrimeLine® weatherboard



PrimeLine® Summit weatherboard

pre-primed board with slender beaded edge and strong lap line; HardieLock® fixing system.



PrimeLine® Heritage weatherboard

pre-primed double board width, with rebated edge to create shadow lines.



PrimeLine® Newport weatherboard

pre-primed smooth, narrow board; HardieLock® fixing system.



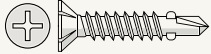
PrimeLine® Chamfer weatherboard

pre-primed double board width, with clean lines to create shadow effect.



PrimeLine® weatherboard

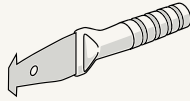
What are the accessories?



305532 HardieDrive™ Screws 32mm long

A class 3 finish self-tapping wing-tipped screw for fastening to 0.8mm to 1.6mm BTM steel frames.

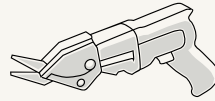
Selling unit: 500 per box



305576 James Hardie™ Score and Snap Knife

A tungsten tipped knife for scoring fibre cement sheets.

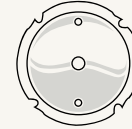
Selling unit: 20 per box



300653 James Hardie™ Fibreshears

Electric tool for cutting fibre cement sheets.

Selling unit: 1 each



300660/303375 HardieBlade™ Saw Blade

A poly-diamond blade for fast and clean cutting of James Hardie fibre cement

Selling unit: 1 Each

Diameter: 185mm/254mm

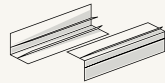


305534 James Hardie™ Joint Sealant*

A general purpose, paintable, exterior grade polyurethane joint sealant.

Selling unit: 20 per box
300ml cartridge

* Not to be used in fire applications.

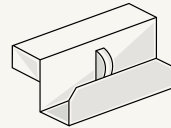


305513 James Hardie™ Aluminium Snap On Corner

A ready to paint aluminium extrusion set, to be used with HardiePlank™ weatherboard and PrimeLine® weatherboard, at internal and external corner junctions to conceal the board edge.

Selling unit: 5 sets per pack

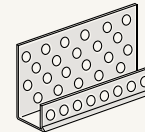
Length: 3,000mm
(2 pieces per set).



305525 PrimeLine® Galvanised Universal Off Stud Joint Clip

A galvanised metal clip to be used for off stud jointing of PrimeLine® Heritage and PrimeLine® Chamfer weatherboards.

Selling unit: 100 per box



305568 James Hardie™ 7.5mm PVC Starter Strip

A perforated PVC extrusion, used with HardieTex™ sheet to provide a straight edge to finish the texture coating or used with PrimeLine® Newport or Summit weatherboard to secure the bottom row at the correct angle.

Selling unit: 25 per pack

Length: 3,000mm

HardiePlank™ weatherboard



HardiePlank™ Old Style weatherboard.

What is it?

A no-fuss, site-painted weatherboard available in a range of different profiles, from contemporary to traditional. The range includes:

HardiePlank™ Woodgrain. Traditional woodgrain

HardiePlank™ Smooth. Modern straight lines

HardiePlank™ Old Style. A smooth surface and rebated edges to create shadow lines

HardiePlank™ Rusticated. Pre-primed with a subtle timber grain, and rebated edges to create shadow lines.

Where do you use it?

As an external cladding in residential single and medium-density homes, including alterations and additions, where a cost-effective traditional or contemporary weatherboard look is required. Ideal for full wrap or composite construction designs on either timber or light gauge steel framed homes.

What are the key benefits?

DESIGN FLEXIBILITY. A wide variety of looks can be achieved with the varying profiles in the range.

VERSATILITY. It can also be used as bracing.*

SECURITY. HardiePlank weatherboard is resistant to damage from termites, rot and fire.** A 25-year product warranty gives peace of mind.

Note All dimensions and masses provided are approximate only and subject to manufacturing tolerances. Masses are based on equilibrium moisture content of product.

* When installed in accordance with James Hardie's *Structural Bracing Design Guide*.

** When installed and maintained correctly and to the extent set out in James Hardie's published literature current at the time of installation.

HardiePlank™ weatherboard

Figure 6 External corner option

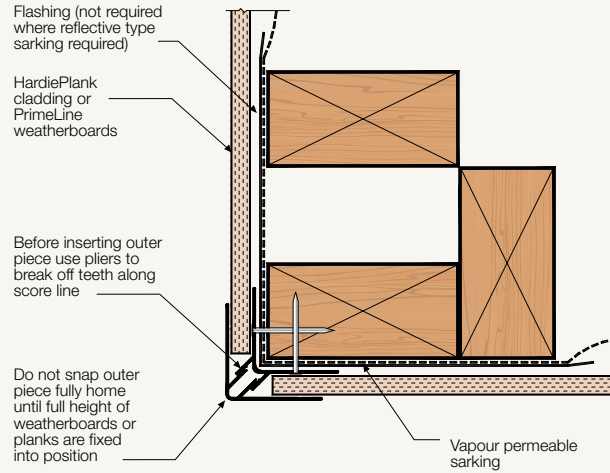
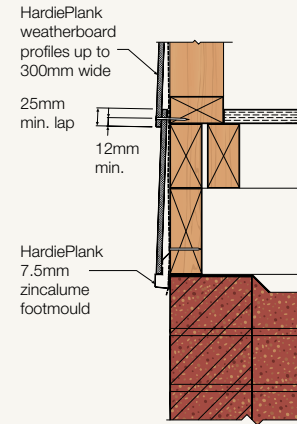


Figure 7 Nail spacings and lap



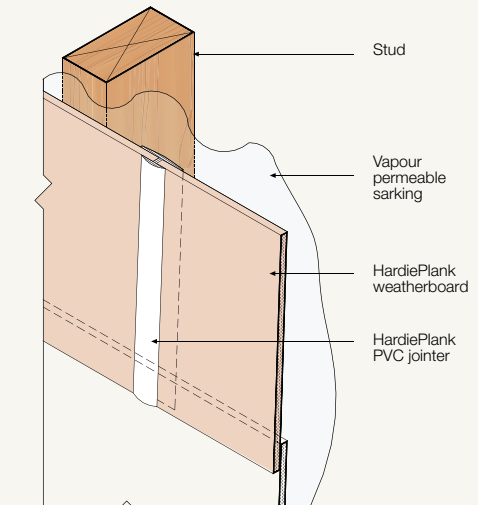
What are the sizes?

Product code	Profile	Length (mm)	Width (mm)	Thickness (mm)	Mass (kg/m)
403080	Woodgrain	4,200	230	7.5	2.9
403081	Woodgrain	4,200	300	7.5	3.8
400265	Smooth	4,200	230	7.5	2.9
400266	Smooth	4,200	300	7.5	3.8
400371	Old Style	4,200	205	7.5	2.5
400378	Rusticated	4,200	205	7.5	2.5

Selling units per pack:

120 lengths per full pack, 60 lengths per half pack

Figure 8 PVC jointer



HardiePlank™ weatherboard



**HardiePlank™
Woodgrain
weatherboard**
with traditional
woodgrain finish.



**HardiePlank™
Smooth
weatherboard**
with straight
modern lines.



**HardiePlank™ Old
Style weatherboard**
with a smooth surface
and rebated edges to
create shadow lines.



**HardiePlank™
Rusticated
weatherboard**
pre-primed with a
subtle timber grain
and rebated edges to
create shadow lines.



HardiePlank™ weatherboard

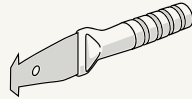
What are the accessories?



305532 HardieDrive™ Screws 32mm long

A class 3 finish self-tapping wing-tipped screw for fastening to 0.8mm to 1.6mm BTM steel frames.

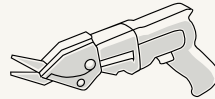
Selling unit: 500 per box



305576 James Hardie™ Score and Snap Knife

A tungsten tipped knife for scoring fibre cement sheets.

Selling unit: 20 per box



300653 James Hardie™ Fibreshears

Electric tool for cutting fibre cement sheets.

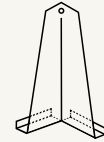
Selling unit: 1 each



305514/305515 HardiePlank™ Aluminium External Corner Soaker

A ready to paint aluminium corner soaker, to be used with HardiePlank™ weatherboard, at external corner junctions to conceal the board edge.

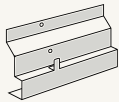
Selling unit: 100 per box
For: 230mm/300mm



305516/305517 HardiePlank™ Aluminium Internal Corner Soaker

A ready to paint aluminium corner soaker, to be used with HardiePlank™ weatherboard, at internal corner junctions to conceal the board edge.

Selling unit: 100 per box
For: 230mm/300mm



305528 HardiePlank™ Zinalume Footmould

A zincalume starter strip to be used with HardiePlank™ weatherboard to kick out the bottom row to the correct angle.

Selling unit: 10 per pack
Length: 3,000mm



305534 James Hardie™ Joint Sealant*

A general purpose, paintable, exterior grade polyurethane joint sealant.

Selling unit: 20 per box
300ml cartridge

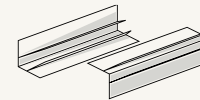
* Not to be used in fire applications.



305524 HardiePlank™ Galvanised Stud Clip

A galvanised metal stud clip to be used with HardiePlank™ weatherboard to automatically set a 25mm lap.

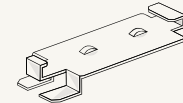
Selling unit: 100 per box



305513 James Hardie™ Aluminium Snap On Corner

A ready to paint aluminium extrusion set, to be used with Scyon™ Axon™ cladding, HardiePlank™ weatherboard and PrimeLine® weatherboard, at internal and external corner junctions to conceal the board edge.

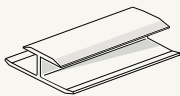
Selling unit: 5 sets per pack
Length: 3,000mm (2 pieces per set).



305523/305522/305527 HardiePlank™ Galvanised Soaker Jointer

A galvanised metal jointer used to join HardiePlank™ weatherboards. It's a concealed alternative to PVC jointers.

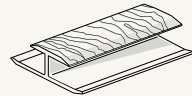
Selling unit: 60 per box
For: 205mm/230mm/300mm



305548/305549 HardiePlank™ Smooth PVC Jointer

A smooth PVC extrusion used to join HardiePlank™ weatherboards.

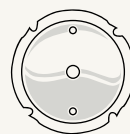
Selling unit: 100 per box
For: 230mm/300mm



305550/305551 HardiePlank™ Woodgrain PVC Jointer

A woodgrain textured PVC extrusion used to join HardiePlank™ weatherboards.

Selling unit: 100 per box
For: 230mm/300mm



300660/303375 HardieBlade™ Saw Blade

A poly-diamond blade for fast and clean cutting of James Hardie fibre cement

Selling unit: 1 Each
Diameter: 185mm/254mm

PanelClad® sheet



What is it?

A pre-textured, site-painted sheet in two modern styles:

PanelClad® Stucco sheet. A hand-trowelled cement-rendered look, reminiscent of a Mediterranean style

PanelClad® TextureLine sheet. A rough-hewn, vertical board and batten surface that gives the effect of bandsawn timber.

Where do you use it?

As an external or internal wall cladding in residential single and medium-density homes, including alterations and additions, where a textured feature panel is required. Ideal for creating whole walls of interest or to emphasise design features such as gable ends, on either timber or light gauge steel framed homes.

What are the key benefits?

FAST INSTALLATION. PanelClad sheet is lightweight and its square edges, together with the wide range of James Hardie™ accessories, make it easy and fast to install by tradespeople, owner-builders and renovators.

VERSATILITY. PanelClad sheet can also be used as bracing.*

SECURITY. PanelClad sheet is resistant to damage from termites, rot and fire.** A 10-year product warranty gives peace of mind.

What are the sizes?

Product code	Profile	Length (mm)	Width (mm)	Thickness (mm)	Mass (kg/m ²)
400404	Stucco	2,440	1,200	6	10
400417	TextureLine	2,700	1,198	6	9.5

Selling units per pack:
30 sheets or each



**PanelClad®
Stucco sheet**
a hand-trowelled
cement-rendered finish



**PanelClad®
TextureLine sheet**
a rough-hewn, board
and batten finish

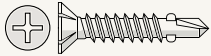
Note All dimensions and masses provided are approximate only and subject to manufacturing tolerances. Masses are based on equilibrium moisture content of product.

* When installed in accordance with James Hardie's *Structural Bracing Design Guide*.

** When installed and maintained correctly and to the extent set out in James Hardie's published literature current at the time of installation.

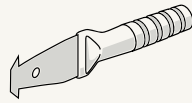
PanelClad® sheet

What are the accessories?



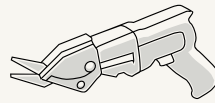
**305532 HardieDrive™
Screws 32mm long**

A class 3 finish self-tapping wing-tipped screw for fastening to 0.8mm to 1.6mm BTM steel frames.
Selling unit: 500 per box



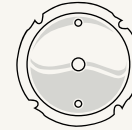
**305576 James Hardie™
Score and Snap Knife**

A tungsten tipped knife for scoring fibre cement sheets.
Selling unit: 20 per box



**300653 James Hardie™
Fibreshears**

Electric tool for cutting fibre cement sheets.
Selling unit: 1 each



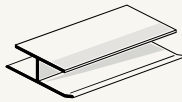
**300660/303375
HardieBlade™ Saw Blade**

A poly-diamond blade for fast and clean cutting of James Hardie fibre cement
Selling unit: 1 Each
Diameter: 185mm/254mm



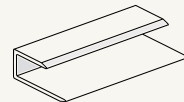
**305534 James Hardie™
Joint Sealant***

A general purpose, paintable, exterior grade polyurethane joint sealant.
Selling unit: 20 per box
300ml cartridge
* Not to be used in fire applications.



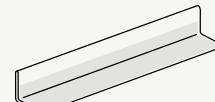
**305566 PanelClad®
TextureLine PVC
Straight Jointer**

A smooth PVC extrusion used to join 6mm thick PanelClad® Textureline sheets.
Selling unit: 25 per pack
Length: 2,700mm



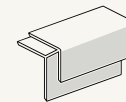
**305543 James Hardie™
PVC Cap Mould for 6mm
thick sheets**

A PVC extrusion used to finish 6mm thick sheet edges.
Selling unit: 25 per pack
Length: 3,000mm



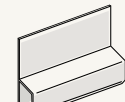
**305554 James Hardie™
45x45mm PVC Corner
Angle Mould**

A PVC extrusion used to finish internal and external corners.
Selling unit: 25 per pack
Length: 3,000mm



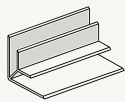
**305544 James Hardie™
PVC External Corner
Angle for 6mm thick sheets**

A PVC extrusion, to be used with 6mm thick sheets at external corner junctions to conceal the sheet edge.
Selling unit: 25 per pack
Length: 3,000mm



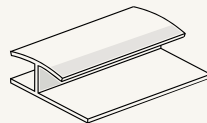
**305552 James Hardie™
PVC Flashing Mould for
6mm thick sheets**

A PVC extrusion for multicourse fixing of 6mm thick sheets.
Selling unit: 25 per pack
Length: 3,000mm



**305545 James Hardie™
PVC Internal Corner Angle
for 6mm thick sheets**

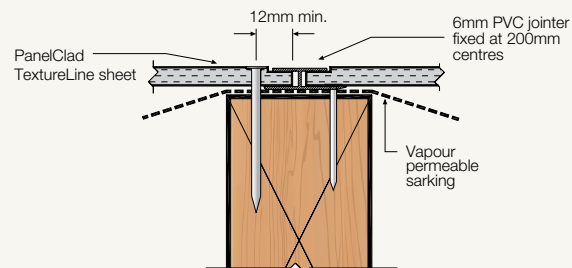
A PVC extrusion, to be used with 6mm thick sheets at internal corner junctions to conceal the sheet edge.
Selling unit: 25 per pack
Length: 3,000mm



**305546 James Hardie™
PVC Straight Jointer for
6mm thick sheets**

A PVC extrusion used to join 6mm thick sheets.
Selling unit: 25 per pack
Length: 3,000mm

Figure 9 TextureLine joint



ExoTec® facade panel and fixing system

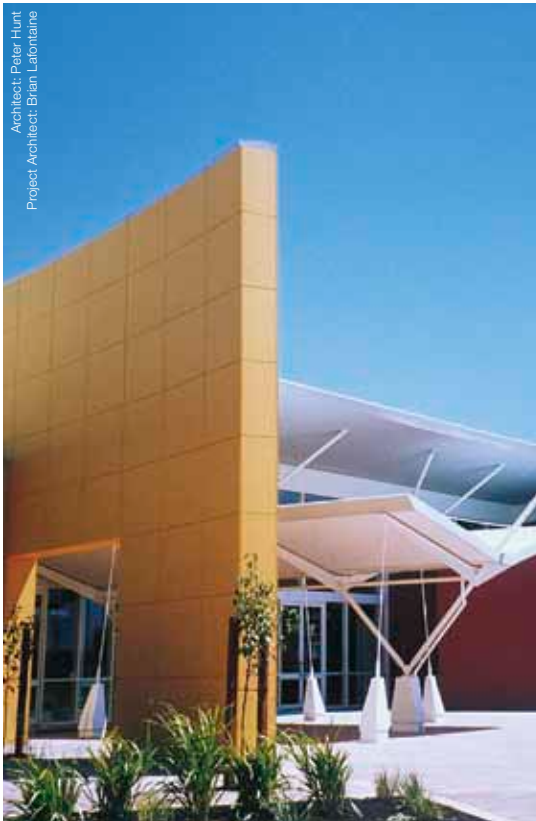
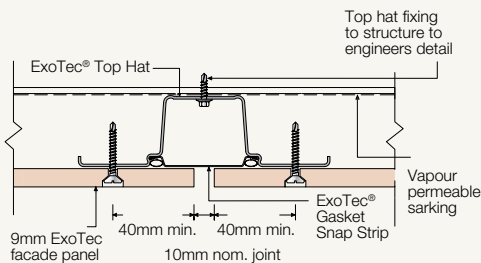


Figure 10 Top hat and panel fixing detail



Note All dimensions and masses provided are approximate only and subject to manufacturing tolerances. Masses are based on equilibrium moisture content of product.

* When installed and maintained correctly and to the extent set out in James Hardie's published literature current at the time of installation.

What is it?

A fully sealed, compressed facade panel installed with a proprietary fixing system. Features expressed joints and is either site-painted or pre-finished off-site. ExoTec facade panel is the most popular fibre-cement commercial facade system.

Where do you use it?

As an external facade, fascia or soffit on commercial buildings requiring a durable, low-maintenance and impact-resistant system, and an expressed-jointed panel look. It's suitable for either full wrap panel or composite designs.

What are the key benefits?

DESIGN FLEXIBILITY. A variety of panel patterns can be achieved, including vertical, horizontal and staggered – fixed with a choice of either countersunk concealed fasteners or exposed screw heads. To add to this, a wide range of decorative paint finishes can be used, including site-applied acrylic textures and factory-applied polyurethane plain and metallic colours.

EASY SPECIFICATION. The designer and installer do not need to make allowances for panel expansion or contraction resulting from weather change, because the compressed panel is sealed on all sides, making it very stable, and the design of the proprietary fixing system helps to absorb any building movement.

DURABILITY. The compressed panel structure delivers high levels of impact resistance, making it a smart choice for commercial areas that are prone to wear and tear.

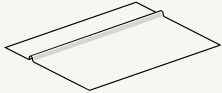
FAST INSTALLATION. The reliable proprietary fixing system makes commercial installations fast, easy and cost-effective.

MOISTURE RESISTANCE. The compressed panels are sealed on all six sides to improve moisture resistance. Added to this, the proprietary ExoTec® Gasket Snap Strip provides an initial weather seal which further improves moisture management and building soundness.

SECURITY. ExoTec facade panel and fixing system is resistant to damage from termites, rot and fire.* A 10-year product warranty gives peace of mind.

ExoTec® facade panel and fixing system

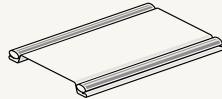
What are the accessories?



**305557/305558/305559
James Hardie™
Backing Strip**

A weather seal at horizontal panel joints for use with ExoTec® façade panel and fixing system and Scyon™ Matrix™ cladding.

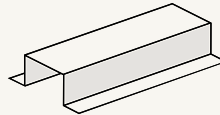
Selling unit:
10 per pack or each
Length: 1,190mm/2,390mm
/2,990mm



**305556 ExoTec® Gasket
Snap Strip**

For use with the ExoTec® façade panel and fixing system, this gasket snap strip is specially designed to clip into the ExoTec® Top Hat at vertical facade panel joints to cover fixings to the structure and to provide an initial weather seal and drainage using a neoprene gasket.

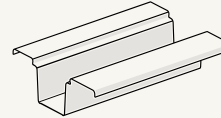
Selling unit: 10 per pack
Length: 3,620mm



**302701/302700
James Hardie™
Intermediate Top Hat**

A metal top hat for use with ExoTec® and ComTex® façade panel and fixing system, for intermediate sheet support. 50mm wide x 35mm deep x 1.15mm gauge thick

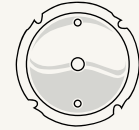
Selling unit:
50 per pack or 1 each
Length:
6,000mm/7,200mm



**304572/304571
ExoTec® Top Hat**

A rolled metal section, for use with ExoTec® facade panel and fixing system, designed to span across the building structure to support façade panels and isolate differential movement of the panels from those of the structure. 124mm wide x 35mm deep x 1.15mm gauge thick.

Selling unit:
45 per pack or 1 each
Length:
6,000mm/7,200mm



**300660/303375
HardieBlade™ Saw Blade**

A poly-diamond blade for fast and clean cutting of James Hardie fibre cement
Selling unit: 1 Each
Diameter: 185mm/254mm



**305534 James Hardie™
Joint Sealant***

A general purpose, paintable, exterior grade polyurethane joint sealant.

Selling unit: 20 per box
300ml cartridge

* Not to be used in fire applications.

What are the sizes?

Product code	Length (mm)	Width (mm)	Thickness (mm)	Mass (kg/m ²)
402200	1,800	900	9	13.95
402201	1,800	1,200	9	13.95
402203	2,100	1,200	9	13.95
402204	2,400	900	9	13.95
402205	2,400	1,200	9	13.95
402333	2,400	1,200	12	18.6
402207	2,700	1,200	9	13.95
402208	3,000	900	9	13.95
402209	3,000	1,200	9	13.95
402334	3,000	1,200	12	18.6

Selling units per pack: 9mm – 16 sheets or each,
12mm – 12 sheets or each



**305565 James Hardie™
Façade Washers**

Façade washers used for exposed fastener fixing with ExoTec® façade panel and fixing system and Scyon™ Matrix™ cladding.

Selling unit: 1000 per bag

ComTex[®] facade panel and fixing system



What is it?

A pre-primed panel that's site-finished with a high-build acrylic texture system that incorporates both reinforced jointing and texture coating. It's used with the proprietary fixing system to create a complete commercial facade system that gives a monolithic, rendered look without the need for masonry.

Where do you use it?

As an external facade on commercial buildings where a lightweight system with a monolithic rendered look is required. Ideal for full wrap or composite construction designs on either timber or light gauge steel framed buildings.

What are the key benefits?

AFFORDABILITY. When it comes to multi-storey construction, two big cost-drivers are scaffolding and structural beams. Using ComTex facade panel and fixing system instead of rendered masonry can help significantly reduce those costs. To add to this, the panels are pre-primed,* which speeds up the finishing process and reduces cost.

DESIGN FLEXIBILITY. Lightweight construction makes it easy to turn the most inspiring design into reality, without the heavy and often costly engineering details that are typically required for masonry construction. Added to this, a variety of textures and colours can be achieved with the site-applied high-build acrylic texture system.

FAST INSTALLATION. The pre-primed panel improves the speed at which the applicator can apply the texture system.

VERSATILITY. When used in conjunction with fire-resistant plasterboard, a fire rating of up to two hours can be achieved for a wall. To add to this, ComTex facade panel can be used as bracing.**

SECURITY. ComTex facade panel and fixing system is resistant to damage from termites, rot and fire.† A 10-year product warranty gives peace of mind.

What are the sizes?

Product code	Length (mm)	Width (mm)	Thickness (mm)	Mass (kg/m ²)
400143	3,000	1,200	9	14.5
400144	2,400	1,200	9	14.5

Selling units per pack:
30 sheets or each or each

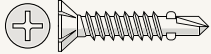
Note All dimensions and masses provided are approximate only and subject to manufacturing tolerances. Masses are based on equilibrium moisture content of product.

* Always refer to the paint manufacturer's guidelines. ** When installed in accordance with James Hardie's *Structural Bracing Design Guide*.

† When installed and maintained correctly and to the extent set out in James Hardie's published literature current at the time of installation.

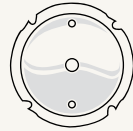
ComTex® facade panel and fixing system

What are the accessories?



**305532 HardieDrive™
Screws 32mm long**

A class 3 finish self-tapping wing-tipped screw for fastening to 0.8mm to 1.6mm BTM steel frames.
Selling unit: 500 per box



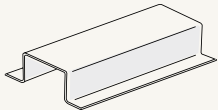
**300660/303375
HardieBlade™ Saw Blade**

A poly-diamond blade for fast and clean cutting of James Hardie fibre cement
Selling unit: 1 Each
Diameter: 185mm/254mm



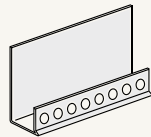
**305534 James Hardie™
Joint Sealant***

A general purpose, paintable, exterior grade polyurethane joint sealant.
Selling unit: 20 per box
300ml cartridge
* Not to be used in fire applications.



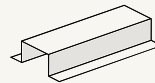
304573 ComTex® Top Hat

A metal top hat for use with ComTex® façade panel and fixing system, behind control joints. 75mm wide x 35mm deep x 1.15mm gauge thick.
Selling unit:
50 per pack or 1 each
Length: 6,000mm



**305553 ComTex®
PVC Starter Strip**

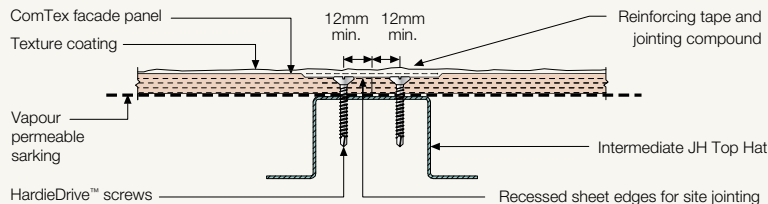
A perforated PVC extrusion used with ComTex® façade panel and fixing system, to provide a straight edge to finish the texture coating.
Selling unit: 25 per pack
Length: 3,600mm



**302701/302700
James Hardie™
Intermediate Top Hat**

A metal top hat for use with ExoTec® and ComTex® façade panel and fixing system, for intermediate sheet support.
50mm wide x 35mm deep x 1.15mm gauge thick
Selling unit:
50 per pack or 1 each
Length:
6,000mm/7,200mm

Figure 11 Set joint



HardieFlex™ sheet in eaves lining sizes



Architect: D'Agostino & Lurf Architects

What is it?

A smooth, flat sheet that is produced in widths specifically made for eaves. It is site-painted to create a flat panel look.

Where do you use it?

It's specifically designed to line eaves and soffits in residential single and medium-density homes, including alterations and additions, where a flat panel look is required. It can be used on either timber or light gauge steel framed homes.

What are the key benefits?

AFFORDABILITY. The speed at which the pre-cut sheets can be joined and installed makes them a cost-effective solution to the often difficult task of fixing eaves.

FAST INSTALLATION. The combination of the JH PVC Straight Jointer and the wide variety of sheet sizes pre-cut specifically for eaves makes it easy and fast to install by tradespeople, owner-builders and renovators.

SECURITY. Made from James Hardie fibre cement, HardieFlex sheet is non-combustible, making it ideal for use in homes built within bushfire-prone areas because it provides additional protection against the ingress of burning embers.* HardieFlex sheet is resistant to damage from termites, rot and fire.** A 10-year product warranty gives peace of mind.

What are the sizes?

Product code	Length (mm)	Width (mm)	Thickness (mm)	Mass (kg/m ²)
400393	2,400	450	4.5	7.7
400392	2,400	600	4.5	7.7
400391	2,400	750	4.5	7.7
400389	2,400	600	6	10

Selling units per pack:

60 sheets or 30 sheets per half pack

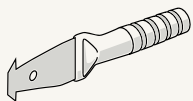
Note All dimensions and masses provided are approximate only and subject to manufacturing tolerances. Masses are based on equilibrium moisture content of product.

* Refer to the relevant council and code for suitability as well as the James Hardie *Bushfire Construction Design Guide*.

** When installed and maintained correctly and to the extent set out in James Hardie's published literature current at the time of installation.

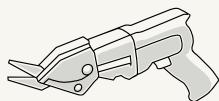
HardieFlex™ sheet in eaves lining sizes

What are the accessories?



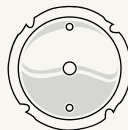
305576 James Hardie™ Score and Snap Knife

A tungsten tipped knife for scoring fibre cement sheets.
Selling unit: 20 per box



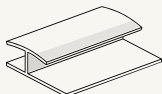
300653 James Hardie™ Fibreshers

Electric tool for cutting fibre cement sheets.
Selling unit: 1 each



300660/303375 HardieBlade™ Saw Blade

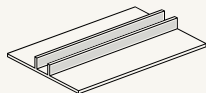
A poly-diamond blade for fast and clean cutting of James Hardie fibre cement
Selling unit: 1 Each
Diameter: 185mm/254mm



305538/305541/305546 James Hardie™ PVC Straight Jointer

PVC extrusion used to join sheets.

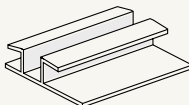
Selling unit: 25 per pack
Length: 2,400mm x 4.5mm
3,000mm x 4.5mm
3,000mm x 6.0mm



305432 James Hardie™ PVC Eave and Soffit Jointer for use with 6mm thick sheets

A black PVC extrusion used to join 6mm thick Versilux® or HardieFlex™ sheets in eave and soffit applications, to give an expressed joint look. Not suitable for external wall cladding applications.

Selling units: 25 per pack
Length: 3,000mm

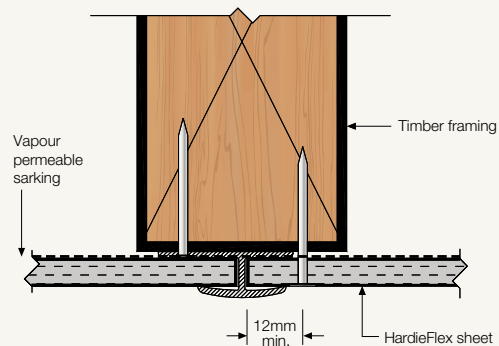


305506 James Hardie™ PVC Eave and Soffit Jointer for use with 4.5mm thick sheets

A PVC extrusion used to join 4.5mm thick Versilux® or HardieFlex™ sheets in eave and soffit applications, to give an expressed joint look. Not suitable for external wall cladding applications.

Selling unit: 25 per pack
Length: 3,000mm

Figure 12 PVC straight jointer fixed to timber framing



Villaboard® lining



What is it?

A flat sheet with long edges recessed for flush jointing. Sanded smooth, Villaboard lining is a seamless flat surface that can be painted, wallpapered or tiled to create a wide range of design looks.

Where do you use it?

As an internal wall and ceiling lining in bathrooms, laundries, kitchens and high-traffic areas in residential, medium-density and commercial buildings, where a durable wet area lining or a durable, seamless flat surface is required for tiles, wallpaper or paint. It can be used on either timber or light gauge steel framed buildings.

What are the key benefits?

TILE ADHESION. Because of its homogeneous composition, Villaboard lining has much greater tensile bond strength than plasterboard, which gives greater tile adhesion. Its tensile bond strength is up to 75% greater than wet area plasterboard when dry, and 300% greater when wet.

DURABILITY. The high impact resistance of Villaboard lining, compared to plasterboard, makes it the smart choice for high-traffic areas that are prone to wear and tear. To add to this, if a tiler makes a mistake when tiling, the homogeneous nature of Villaboard lining means they can chip the back of the tile off without damaging the substrate.

VERSATILITY. It's suitable for use in fire-rated and acoustically rated systems. To add to this, the 6mm thick sheet can also be used as internal bracing.*

SECURITY. The key requirement of linings used in wet areas is superior resistance to moisture damage in the event that the material gets wet. Reduced tile adhesion is one of the main problems moisture penetration causes. Made from James Hardie fibre cement, Villaboard lining is homogeneously resistant to moisture damage, which means that even if the material does get wet, it won't deform or lose its structural integrity, like many other materials.** In both commercial and residential applications, this means less call backs for costly rectifications resulting from moisture damage. To add to this, independent tests on Villaboard lining, conducted in accordance with ASTM D3273-00, concluded that there was no mould growth and resulted in a perfect rating of 10. Villaboard lining is resistant to damage from termites, rot and fire.** A 10-year product warranty gives peace of mind.

Note All dimensions and masses provided are approximate only and subject to manufacturing tolerances. Masses are based on equilibrium moisture content of product.

* When installed in accordance with James Hardie's *Structural Bracing Design Guide*.

** When installed and maintained correctly and to the extent set out in James Hardie's published literature current at the time of installation.

Villaboard® lining

What are the sizes?

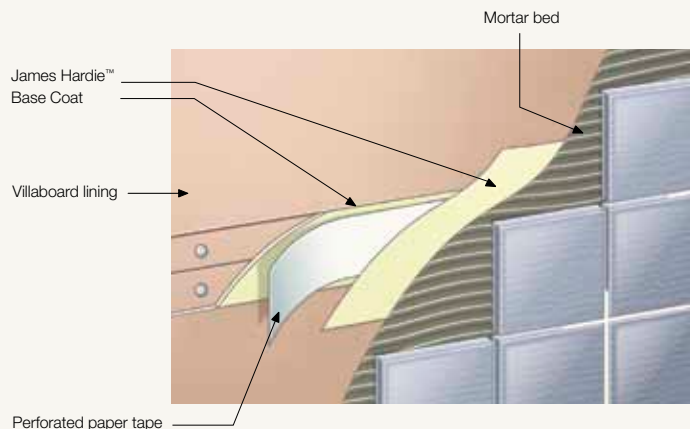
Product code	Length (mm)	Width (mm)	Thickness (mm)	Mass (kg/m ²)
400364	1,800	1,200	6	9.8
400367	2,400	900	6	9.8
400362	2,400	1,200	6	9.8
400357	2,400	1,200	9	13.9
400370	2,400	1,350	6	9.8
400361	2,700	1,200	6	9.8
400356	2,700	1,200	9	13.9
400366	3,000	900	6	9.8
400360	3,000	1,200	6	9.8
400355	3,000	1,200	9	13.9
400352	3,000	1,200	12	18.5
400369	3,000	1,350	6	9.8
403331	3,000	1,350	9*	13.9
400359	3,600	1,200	6	9.8
400354	3,600	1,200	9	13.9
400368	3,600	1,350	6	9.8
400358	4,200	1,200	6	9.8
400363	4,200	1,350	6	9.8

Selling units per pack:

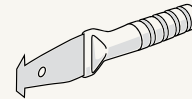
6mm – 60 sheets or multiple of 30 sheets, 9mm – 30 sheets or loose, 12mm – 30 sheets or loose

* Not available in WA or TAS

Figure 13 Villaboard® lining joint cutaway



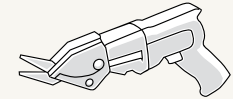
What are the accessories?



305576 James Hardie™ Score and Snap Knife

A tungsten tipped knife for scoring fibre cement sheets.

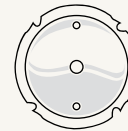
Selling unit: 20 per box



300653 James Hardie™ Fibreshears

Electric tool for cutting fibre cement sheets.

Selling unit: 1 each



300660/303375 HardieBlade™ Saw Blade

A poly-diamond blade for fast and clean cutting of James Hardie fibre cement

Selling unit: 1 Each

Diameter: 185mm/254mm



305534 James Hardie™ Joint Sealant*

A general purpose, paintable, exterior grade polyurethane joint sealant.

Selling unit: 20 per box
300ml cartridge

* Not to be used in fire applications.



304491/305535 James Hardie™ Base Coat

A water-resistant base coat compound used in conjunction with James Hardie™ Top Coat to create a seamless flush joint for Villaboard® lining.

Selling unit:
15kg bag – 1 Each
4kg tub – 4 per box



304493/305536 James Hardie™ Top Coat

A water-resistant top coat compound used in conjunction with James Hardie™ Base Coat to create a seamless flush joint for Villaboard® lining.

Selling unit:
15kg tub – 1 Each
3kg tub – 4 per box

James Hardie™ Base Coat and Top Coat



What is it?

Water-resistant compounds used to create seamless flush joints for Villaboard® lining.

Where do you use it?

With Villaboard® lining; on internal walls and ceilings and sheltered exterior applications including eaves and soffits where a seamless flush joint is required.

What are the key benefits?

DURABILITY. James Hardie Base Coat and Top Coat provide superior joint strength when compared with gypsum jointing compounds.

FAST INSTALLATION. Significant improvements in formulation have made James Hardie Base Coat and Top Coat light in consistency, making it easy to apply.

SECURITY. The superior moisture resistance of James Hardie Base Coat and Top Coat, when compared to gypsum compounds, minimises the risk associated with redoing joints in wet areas, eaves and soffits.



What are the sizes?

James Hardie Base Coat

Product code	Order Unit
305535	4kg tub = 4 per box
304491	15kg bag each

James Hardie Top Coat

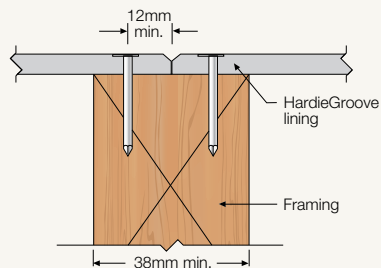
Product code	Order Unit
305536	3kg tub = 4 per box
304493	15kg tub each

Note All dimensions and masses provided are approximate only and subject to manufacturing tolerances. Masses are based on equilibrium moisture content of product.

HardieGroove™ lining



Figure 14 Butt joint



What is it?

A flat sheet that has vertical V-shaped grooves carved into its face. Sanded smooth, it's site-painted to create the traditional look of tongue-and-groove timber panels.

Where do you use it?

As an internal wall lining in residential living areas, hallways, bathrooms (excluding showers) and garages and on soffits where a durable, tongue-and-groove timber panel look is required. It can be used on either timber or light gauge steel framed homes.

What are the key benefits?

DURABILITY. The high impact resistance of HardieGroove lining, compared to timber, makes it the smart choice for high-traffic areas that are prone to wear and tear.

FAST INSTALLATION. The sheet with V-shaped grooves carved into its face gives a look of individual tongue-and-groove panels with the benefit of fast broadwall coverage. To add to this, the sheet edges are finished with a half groove to conceal butt jointing and make it easy to do.

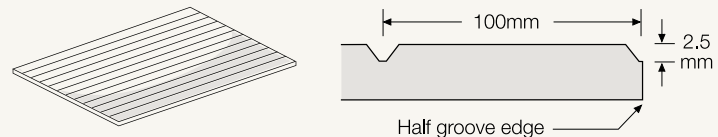
SECURITY. HardieGroove lining is resistant to damage from termites, rot and fire.* A 10-year product warranty gives peace of mind.

What are the sizes?

Product code	Length (mm)	Width (mm)	Thickness (mm)	Mass (kg/m ²)
400245	2,700	1,200	7.5	11.7

Selling units per pack: 20 sheets, or half packs of 10 sheets

Figure 15 HardieGroove™ lining



Note All dimensions and masses provided are approximate only and subject to manufacturing tolerances. Masses are based on equilibrium moisture content of product.

* When installed and maintained correctly and to the extent set out in James Hardie's published literature current at the time of installation.

Versilux[®] lining



What is it?

A flat sheet with square edges for butt joints. Sanded smooth and pre-sealed, Versilux lining is a flat surface that is site-painted to create a panelised look.

Where do you use it?

As an internal wall and ceiling lining in laundries, kitchens and high-traffic areas in residential, medium-density and commercial buildings, where a durable, flat panel look is required. It can also be used in exposed beam ceilings and soffits, and is suitable on either timber or light gauge steel framed buildings.

What are the key benefits?

AFFORDABILITY. Versilux lining is sanded and pre-sealed, making it easy to paint, and reducing the finishing time and cost.*

DESIGN FLEXIBILITY. It's easy to achieve a range of looks with Versilux lining using straight PVC jointers, battens or Scyon™ Axent™ trim, as bold or subtle highlights over their smooth, flat surface.

DURABILITY. The high impact resistance of Versilux lining, compared to plasterboard lining, makes it the smart choice for high-traffic areas that are prone to wear and tear.

FAST INSTALLATION. Versilux lining is lightweight and its square edges, together with the wide range of James Hardie™ accessories, make it easy and fast to install by tradespeople, owner-builders and renovators.

VERSATILITY. It's suitable for use in fire-rated and acoustically rated systems. To add to this, the 6mm thick sheet can also be used as internal bracing.**

SECURITY. Versilux lining is resistant to damage from termites, rot and fire.† A 10-year product warranty gives peace of mind.

Note All dimensions and masses provided are approximate only and subject to manufacturing tolerances. Masses are based on equilibrium moisture content of product.

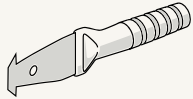
* Always refer to the paint manufacturer's guidelines.

** When installed in accordance with James Hardie's *Structural Bracing Design Guide*.

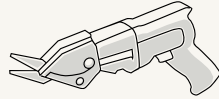
† When installed and maintained correctly and to the extent set out in James Hardie's published literature current at the time of installation.

Versilux® lining

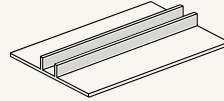
What are the accessories?


**305576 James Hardie™
Score and Snap Knife**

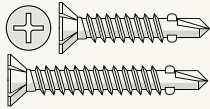
A tungsten tipped knife for scoring fibre cement sheets.
Selling unit: 20 per box


**300653 James Hardie™
Fibreshears**

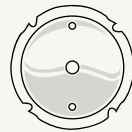
Electric tool for cutting fibre cement sheets.
Selling unit: 1 each


**305432 James Hardie™
PVC Eave and Soffit
Jointer for use with
6mm thick sheets**

A black PVC extrusion used to join 6mm thick Versilux® or HardieFlex™ sheets in eave and soffit applications, to give an expressed joint look. Not suitable for external wall cladding applications.
Selling units: 25 per pack
Length: 3,000mm


**305532 HardieDrive™
Screws 32mm long**

A class 3 finish self-tapping wing-tipped screw for fastening to 0.8mm to 1.6mm BTM steel frames.
Selling unit: 500 per box


**300660/303375
HardieBlade™ Saw Blade**

A poly-diamond blade for fast and clean cutting of James Hardie fibre cement
Selling unit: 1 Each
Diameter: 185mm/254mm

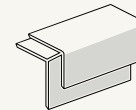
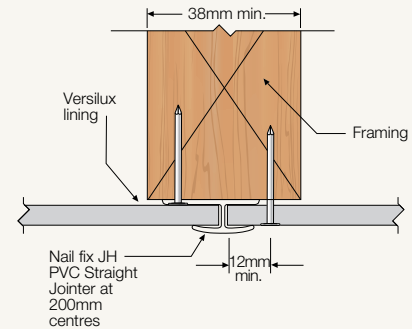
What are the sizes?

Product code	Length (mm)	Width (mm)	Thickness (mm)	Mass (kg/m ²)
400454	2,400	900	4.5*	7.4
400452	2,400	1,200	4.5*	7.4
400424	2,400	1,200	6	9.4
400423	2,700	1,200	6	9.4
401878	2,700	1,200	9	13.7
400425	3,000	900	6	9.4
400450	3,000	1,200	4.5*	7.4
400422	3,000	1,200	6	9.4
400449	3,600	1,200	4.5*	7.4
400421	3,600	1,200	6	9.4

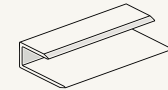
Selling units per pack:

4.5mm – 15 or 30 sheets, 6mm – 15 or 30 sheets, 9mm – loose

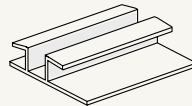
* Not available in WA and TAS..

Figure 16 PVC straight jointer detail

**305544 James Hardie™
PVC External Corner Angle
for 6mm thick sheets**

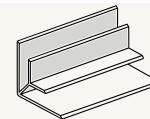
A PVC extrusion, to be used with 6mm thick sheets at external corner junctions to conceal the sheet edge.
Selling units: 25 per pack
Length: 3,000mm


**305542/305543
James Hardie™
PVC Cap Mould**

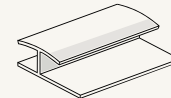
A PVC extrusion used to finish sheet edges.
Selling units: 25 per pack
Length: 3,000mm x 4.5mm
3,000mm x 6.0mm


**305506 James Hardie™
PVC Eave and Soffit
Jointer for use with
4.5mm thick sheets**

A PVC extrusion used to join 4.5mm thick Versilux® or HardieFlex™ sheets in eave and soffit applications, to give an expressed joint look. Not suitable for external wall cladding applications.
Selling unit: 25 per pack
Length: 3,000mm


**305545 James Hardie™
PVC Internal Corner Angle
for 6mm thick sheets**

A PVC extrusion, to be used with 6mm thick sheets at internal corner junctions to conceal the sheet edge.
Selling units: 25 per pack
Length: 3,000mm


**305538/305541/305546
James Hardie™ PVC
Straight Jointer**

PVC extrusion used to join sheets
Selling unit: 25 per pack
Length: 2,400mm x 4.5mm
3,000mm x 4.5mm
3,000mm x 6.0mm

PineRidge® lining



PineRidge® lining
profile showing timber
appearance.

What is it?

A timber-textured, site-painted sheet lining.

Where do you use it?

As an internal wall lining in residential living areas, hallways, garages and workshops, where a durable, timber-panel look is required. It can be used on either timber or light gauge steel framed homes.

What are the key benefits?

DURABILITY. The high impact resistance of PineRidge lining, compared to timber, makes it the smart choice for high-traffic areas that are prone to wear and tear.

FAST INSTALLATION. PineRidge lining is lightweight, and its large sheet sizes and square edges, together with PineRidge® PVC Jointers, make it easy and fast to install by tradespeople, owner-builders and renovators. To add to this, it can also be joined off-stud, which minimises wastage.

VERSATILITY. It can also be used as bracing.*

SECURITY. PineRidge lining is resistant to damage from termites, rot and fire.** A 10-year product warranty gives peace of mind.

What are the sizes?

Product code	Length (mm)	Width (mm)	Thickness (mm)	Mass (kg/m ²)
400373	2,540	1,198	6 [#]	10
400372	2,700	1,198	6 [#]	10

Selling units per pack:

30 sheets or each

[#] PineRidge® lining is not available in WA

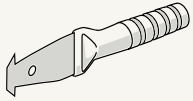
Note All dimensions and masses provided are approximate only and subject to manufacturing tolerances. Masses are based on equilibrium moisture content of product.

* When installed in accordance with James Hardie's *Structural Bracing Design Guide*.

** When installed and maintained correctly and to the extent set out in James Hardie's published literature current at the time of installation.

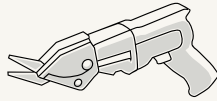
PineRidge® lining

What are the accessories?



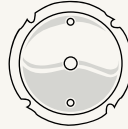
305576 James Hardie™ Score and Snap Knife

A tungsten tipped knife for scoring fibre cement sheets.
Selling unit: 20 per box



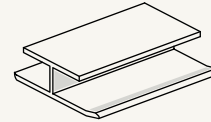
300653 James Hardie™ Fibreshears

Electric tool for cutting fibre cement sheets.
Selling unit: 1 each



300660/303375 HardieBlade™ Saw Blade

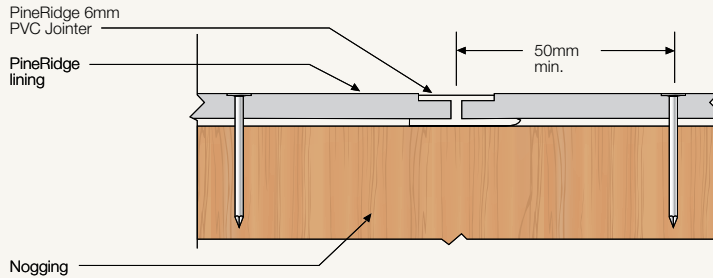
A poly-diamond blade for fast and clean cutting of James Hardie fibre cement.
Selling unit: 1 Each
Diameter: 185mm/254mm



305539 PineRidge® PVC Joints

A PVC extrusion used to join 6mm thick PineRidge® lining.
Selling unit: 25 per pack
Length: 2,700mm

Figure 17 Sheet joint detail



HardiePanel™ compressed sheet



What is it?

A structural flooring substrate for ceramic tile finishes over timber or lightweight steel floor joists; it's made from durable compressed fibre cement.

Where do you use it?

As an internal substrate for tiled wet-area floors and an external substrate for tiled balconies, verandas and decks, in both residential and commercial buildings. It's a durable, moisture-resistant alternative to particleboard and plywood substrates, and a lightweight alternative to concrete.

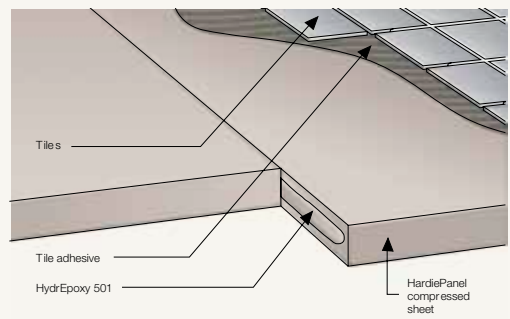
What are the key benefits?

DURABILITY. The compressed sheet structure delivers a high level of durability and stability, making it an ideal flooring substrate for both internal and external use, in residential and commercial buildings.

VERSATILITY. HardiePanel compressed sheet can also be used as formwork in a range of industrial and commercial applications such as bridges and roadworks.* To add to this, it's deemed non-combustible in accordance with the provisions of the Building Code of Australia, and can be used for floors in bushfire-prone areas.

SECURITY. HardiePanel compressed sheet is resistant to damage from termites, rot and fire.** A 10-year product warranty gives peace of mind.

Figure 18 Internal flooring joint detail



This picture refers to the internal application only (James Hardie does not recommend HydrEpoxy 501 in an external situation)

Note All dimensions and masses provided are approximate only and subject to manufacturing tolerances. Masses are based on equilibrium moisture content of product.

* Subject to appropriate independent structural engineering specification. For more information Ask James Hardie™ Call 13 11 03.

** When installed and maintained correctly and to the extent set out in James Hardie's published literature current at the time of installation.

HardiePanel™ compressed sheet

What are the sizes?

Product code	Length (mm)	Width (mm)	Thickness (mm)	Mass (kg/m ²)
400090	1,500*	900*	15	28.8
400101	1,500*	900*	18	34.5
400084	1,500*	1,200*	15	28.8
400097	1,500*	1,200*	18	34.5
400089	1,800	900	15	28.8
400100	1,800	900	18	34.5
400083	1,800	1,200	15	28.8
400096	1,800	1,200	18	34.5
400082	2,100	1,200	15	28.8
400095	2,100	1,200	18	34.5
400087	2,400	900	15	28.8
400099	2,400	900	18	34.5
400081	2,400	1,200	15	28.8
400094	2,400	1,200	18	34.5
400461	2,400	1,200	24	46.9
400080	2,700	1,200	15	28.8
400085	3,000	900	15	28.8
400098	3,000	900	18	34.5
400079	3,000	1,200	15	28.8
400460	3,000	1,200	18	34.5

Selling units per pack: 15mm - 10 sheets or each, 18mm - 8 sheets or each, 24mm - 6 sheets or each

* Not available in WA.

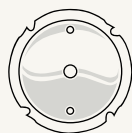
What are the accessories?



305529 HydrEpoxy® 501 (two-part epoxy, 2 litre set)*

A two-part epoxy to join HardiePanel™ compressed sheets.

Selling unit: 1 set includes both Part A and Part B tubs



300660/303375 HardieBlade™ Saw Blade

A poly-diamond blade for fast and clean cutting of James Hardie fibre cement

Selling unit: 1 Each

Diameter: 185mm/254mm

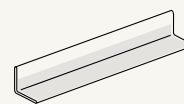


305534 James Hardie™ Joint Sealant*

A general purpose, paintable, exterior grade polyurethane joint sealant.

Selling unit: 20 per box
300ml cartridge

* Not to be used in fire applications.



305554 James Hardie™ 45x45mm PVC Corner Angle Mould

Forms primary flashing between water-resistant deck and wall.

Selling unit: 25 per pack
Length: 3,000mm

* To be used in internal applications only – James Hardie does not recommend HydrEpoxy 501 in an external situation

James Hardie™ ceramic tile underlay



What is it?

An internal underlay for ceramic tile finishes which helps protect against movement that occurs naturally in timber, particleboard and plywood substrates.

Where do you use it?

On top of internal timber, particleboard and plywood substrates, and under ceramic tiles, in either wet or dry areas.

What are the key benefits?

FAST INSTALLATION. The large sheet comes with a pre-marked nailing pattern, which reduces the time the installer has to spend working out where to nail. To add to this, it can be gun nailed with underlay gun nails, which speeds up installation. Also, the underlay is pre-sealed, which improves moisture resistance, giving the tiler more time to lay the tiles before the tile adhesive cures.

SECURITY. Its application over internal timber, particleboard and plywood substrates helps to minimise tile movement and potential tile cracking caused by the expansion and contraction of these substrates. To add to this, the key requirement of materials used in wet areas is superior resistance to moisture damage in the event that the material gets wet. Reduced tile adhesion is one of the main problems moisture penetration causes. Made from James Hardie fibre cement, James Hardie ceramic tile underlay is homogeneously resistant to moisture damage, which means that even if the material does get wet, it won't deform or lose its structural integrity,* like many other materials, and it can help protect against potential costly rectifications resulting from moisture damage. It's also resistant to damage from termites, rot and fire.* A 10-year product warranty gives peace of mind.

What are the sizes?

Product code	Length (mm)	Width (mm)	Thickness (mm)	Mass (kg/m ²)
403190	1,800	1,200	6	9.5

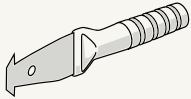
Selling units per pack: 30 sheets

Note All dimensions and masses provided are approximate only and subject to manufacturing tolerances. Masses are based on equilibrium moisture content of product.

* When installed and maintained correctly and to the extent set out in James Hardie's published literature current at the time of installation.

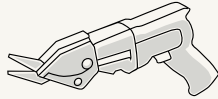
James Hardie™ ceramic tile underlay

What are the accessories?



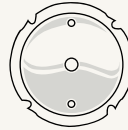
305576 James Hardie™ Score and Snap Knife

A tungsten tipped knife for scoring fibre cement sheets.
Selling unit: 20 per box



300653 James Hardie™ Fibreshears

Electric tool for cutting fibre cement sheets.
Selling unit: 1 each

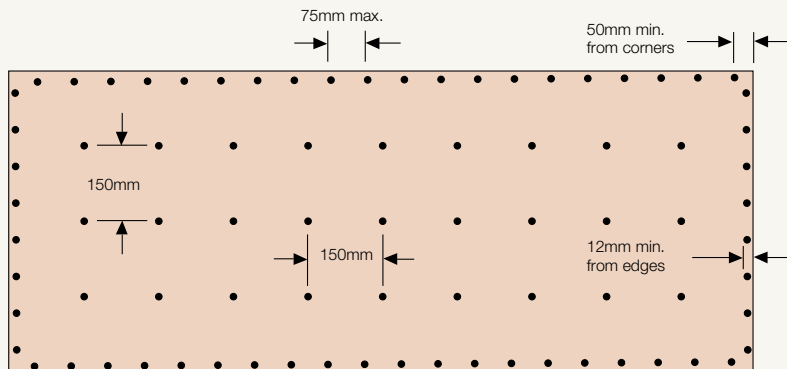


300660/303375 HardieBlade™ Saw Blade

A poly-diamond blade for fast and clean cutting of James Hardie fibre cement.
Selling unit: 1 Each
Diameter: 185mm/254mm



Figure 19 Ceramic tile underlay fastener sheet layout



James Hardie™ vinyl and cork underlay



What is it?

An internal underlay used over timber, plywood or particleboard floors to provide a smooth base for laying either vinyl or cork.

Where do you use it?

On top of internal timber, plywood and particleboard substrates, and under vinyl or cork.

What are the key benefits?

FAST INSTALLATION. The sheet comes with a pre-marked nailing pattern, which reduces the time the installer has to spend working out where to nail. To add to this, it can be gun nailed with underlay gun nails, which speeds up installation.

SECURITY. It's resistant to damage from termites, rot and fire.* A 10-year product warranty gives peace of mind.

What are the sizes?

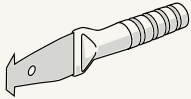
Product code	Length (mm)	Width (mm)	Thickness (mm)	Mass (kg/m ²)
400459	1,200	900	5	8.4

Selling units per pack: 30 sheets

Note All dimensions and masses provided are approximate only and subject to manufacturing tolerances. Masses are based on equilibrium moisture content of product.
* When installed and maintained correctly and to the extent set out in James Hardie's published literature current at the time of installation.

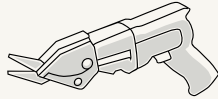
James Hardie™ vinyl and cork underlay

What are the accessories?



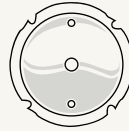
305576 James Hardie™ Score and Snap Knife

A tungsten tipped knife for scoring fibre cement sheets.
Selling unit: 20 per box



300653 James Hardie™ Fibreshears

Electric tool for cutting fibre cement sheets.
Selling unit: 1 each



300660/303375 HardieBlade™ Saw Blade

A poly-diamond blade for fast and clean cutting of James Hardie fibre cement.
Selling unit: 1 Each
Diameter: 185mm/254mm

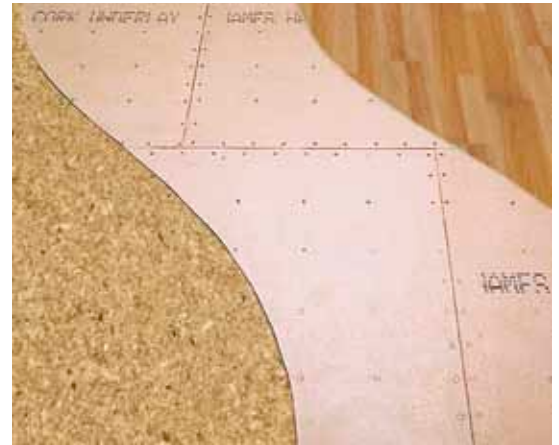
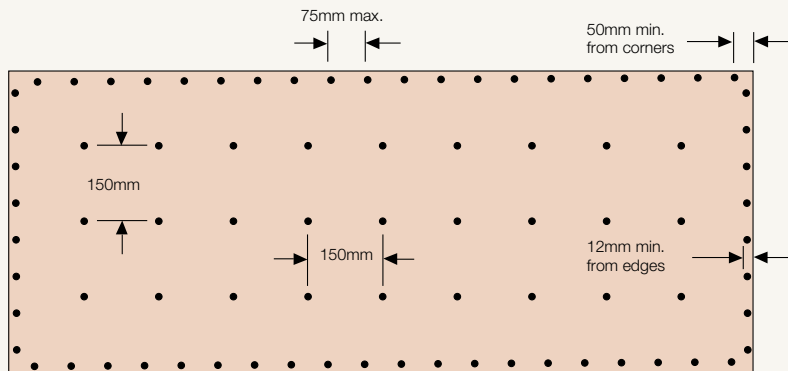


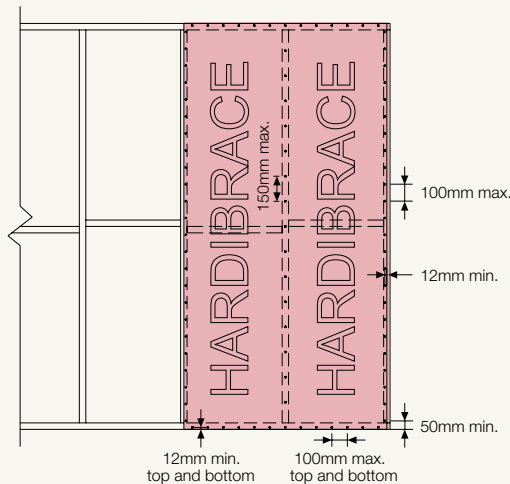
Figure 20 Vinyl and cork underlay fastener sheet layout



HardieBrace™ sheet



Figure 21 Type A nailing detail



What is it?

A 5mm thick, durable bracing sheet.

Where do you use it?

Externally, under wall cladding on residential and medium-density homes on either timber or light gauge steel frames to provide structural* bracing against lateral forces (such as wind) or racking shear (from movement such as earthquakes).

What are the key benefits?

FAST INSTALLATION. The large sheets come with a pre-marked nailing pattern, which reduces the time the installer has to spend working out where to nail. To add to this, it can be gun nailed, which speeds up installation time.

VERSATILITY. It's the only primary-use bracing material that is suitable for bracing applications and nailing patterns as outlined in AS 1684 and the Building Code of Australia.

SECURITY. Made from James Hardie fibre cement, it's resistant to damage from moisture, so if rain holds you up during construction the product won't warp and twist,** and need replacing, like some timber bracing products. HardieBrace sheet is resistant to damage from termites, rot and fire.† A 10-year product warranty gives peace of mind.

What are the sizes?

Product code	Length (mm)	Width (mm)	Thickness (mm)	Mass (kg/m ²)
400159	2,440	925	5	8.7
400157	2,440	1,225	5	8.7
400158	2,725	925	5	8.7
400156	2,725	1,225	5	8.7

Selling units per pack: 30 sheets

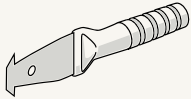
Note All dimensions and masses provided are approximate only and subject to manufacturing tolerances. Masses are based on equilibrium moisture content of product.

* Exposure to the elements should not be longer than three months. ** When installed in accordance with James Hardie's *Structural Bracing Design Guide*.

† When installed and maintained correctly and to the extent set out in James Hardie's published literature current at the time of installation.

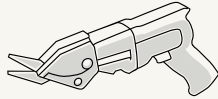
HardieBrace™ sheet

What are the accessories?



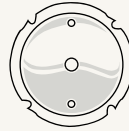
305576 James Hardie™ Score and Snap Knife

A tungsten tipped knife for scoring fibre cement sheets.
Selling unit: 20 per box



300653 James Hardie™ Fibreshers

Electric tool for cutting fibre cement sheets.
Selling unit: 1 each



300660/303375 HardieBlade™ Saw Blade

A poly-diamond blade for fast and clean cutting of James Hardie fibre cement.
Selling unit: 1 Each
Diameter: 185mm/254mm



HardieFence™ EasyLock® system (available in WA only)



What is it?

A site-painted, postless system, incorporating 7mm thick interlocking HardieFence sheets with a metal top cap; suited for sandy soil on either sloping or flat sites.

Where do you use it?

On sloping or level residential sites, in Western Australia, where a durable, freestanding fence is required.

What are the key benefits?

DESIGN FLEXIBILITY. HardieFence sheet has an overlap on one edge, and an underlap (or smaller corrugation) on the other edge to enable seamless interlocking. This gives a consistent look on either side of the fence, and keeps neighbours happy. To add to this, it's postless, and there are no protruding bolts, sharp edges or nails. It can also be site-painted in a full range of exterior paint colours.

FAST INSTALLATION. There is no need to dig post holes and wait for concrete footings to cure, making installation fast.

SECURITY. HardieFence EasyLock system is designed to be buried into sandy soils, eliminating gaps below the fence on both level and sloping sites. This provides a barrier to weeds growing under the fence and is a great benefit when trying to keep even the most enthusiastic dog from getting out. HardieFence EasyLock system is resistant to damage from termites, rot and fire.* A 10-year product warranty gives peace of mind.

What are the sizes?

Product code	Length (mm)	Width (mm)	Thickness (mm)	Mass (kg/m ²)
400150	1,800	1,105	7	13.7
400149	2,400	1,105	7	13.7

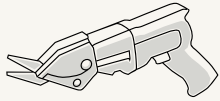
Selling units per pack: 60 or 30 sheets

Note All dimensions and masses provided are approximate only and subject to manufacturing tolerances. Masses are based on equilibrium moisture content of product.

* When installed and maintained correctly to the extent set out in James Hardie's published literature current at the time of installation.

HardieFence™ EasyLock® system (available in WA only)

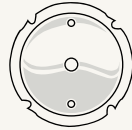
What are the accessories?



300653 James Hardie™ Fibreshears

Electric tool for cutting fibre cement sheets.

Selling unit: 1 each



300660/303375 HardieBlade™ Saw Blade

A poly-diamond blade for fast and clean cutting of James Hardie fibre cement

Selling unit: 1 Each

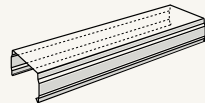
Diameter: 185mm/254mm



305563 HardieFence™ Clips

Metal clips used with the HardieFence™ EasyLock® system for securing lapped sheets together.

Selling unit: 500 per pack



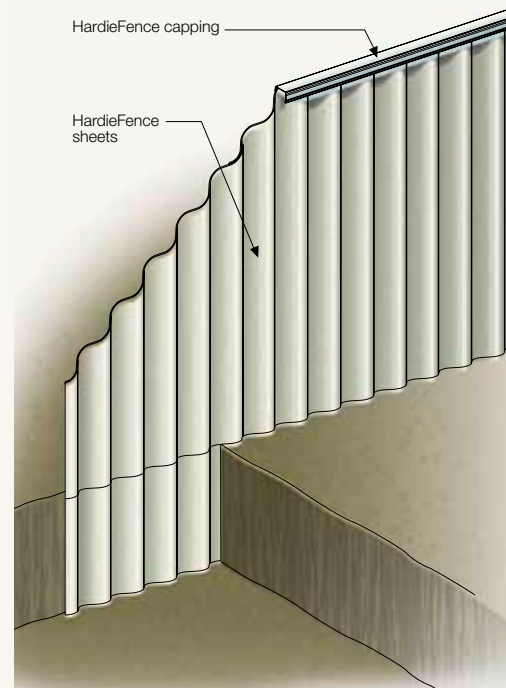
305562/305561 HardieFence™ Capping

Used with the HardieFence™ EasyLock® system as capping for the HardieFence™ sheet.

Selling unit: 8 per pack

Length: 3,750mm/1,875mm

Figure 22 HardieFence™ EasyLock® system cutaway



HardieBreak™ thermal strip



What is it?

A 12mm thick, compliant thermal break strip, made from a hard, unique dual-layer density configuration* of polyolefin insulating material with closed cell technology, that gives it excellent compression resistance and great strength. Specially designed for use behind James Hardie™ and Scyon™ external cladding on steel frames in residential, medium density, transportable and commercial applications to reduce thermal bridging.

Where do you use it?

HardieBreak™ thermal strip has been specifically designed for use behind James Hardie™ and Scyon™ external cladding on steel frames in residential, medium density, transportable and commercial applications, to reduce thermal bridging.

What are the key benefits?

DURABILITY. The material makeup and unique dual-layer configuration* of HardieBreak™ thermal strip contributes to its excellent compression resistance and great strength. These performance attributes enable it to provide the necessary support to the cladding to help reduce facade waviness, and a robustness that minimises breakage during handling and installation. HardieBreak™ thermal strip is also non-absorbent and mould resistant, which helps reduce the likelihood of rusting in steel frames that could potentially void steel frame warranty. It's also termite resistant**.

ENHANCES THERMAL PERFORMANCE. When installed, HardieBreak™ thermal strip improves a walls R value by up to 12%** compared to other commonly available R0.2 m²K/W thermal break strips (when the appropriate anti-glare vapour permeable membrane is installed), and up to 30% compared to walls having no thermal break at all. This is attributed to a number of factors including its thickness and hardness, and also the cavity air-gap it creates between the cladding and sarking when it's installed. It can also minimise heat leakage through metal window frames in a home when installed behind the window.

* Patent pending.

** When installed and maintained correctly and to the extent set out in James Hardie's published literature current at the time of installation.

HardieBreak™ thermal strip

FAST INSTALLATION. HardieBreak™ thermal strip has been designed to fit the length of common wall frames to help reduce on-site cutting and wastage. And when it does need to be cut, it's done easily with a Stanley knife. Its thickness enables cladding to be installed with commonly available screws and its hardness minimises façade waviness. Added to this, HardieBreak™ thermal strip is 43mm wide which makes it extra efficient to install when faced with wide stud applications that may be required for some external cladding, as only one strip is needed. The self-adhesive backing tape on HardieBreak™ thermal strip sticks directly to vapour permeable barrier for easy and fast installation. HardieBreak™ thermal strips are packed flat for easy handling.

BOOSTS WALL PERFORMANCE. In addition to its thermal attributes, HardieBreak™ thermal strip reduces ghosting effects seen in some cladding installed onto steel framed walls in cool climates. And because it creates a cavity in the wall when installed, which acts as a drainage plane to help moisture escape from the wall, it has the ability to help protect a wall from moisture damage and mould growth.

SECURITY. HardieBreak™ thermal strip has been specifically designed by James Hardie for use behind James Hardie™ and Scyon™ external cladding on steel frames, and to satisfy BCA thermal break requirements – it's the thermal break recommended by James Hardie.

What are the sizes?

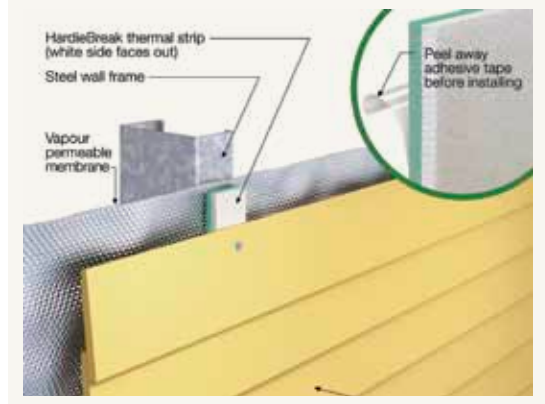
Product code	Length (mm)	Width (mm)	Thickness (mm)	Pack Weight (kg)	Pack Weight (LM)
305612	2,750	43	12	10.3	123.75

Selling units per pack: 45

Figure 23 HardieBreak™ Thermal Strip next to a window



Figure 24 General Installation Overview



Note All dimensions and masses provided are approximate only and subject to manufacturing tolerances. Masses are based on equilibrium moisture content of product.

HardieBreak™ thermal strip

Figure 25 Installation of HardieBreak™ Thermal Strip for flat sheet direct fix

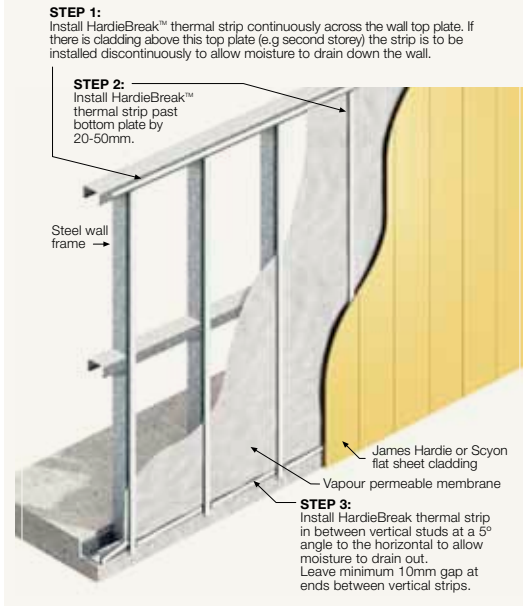
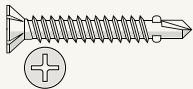


Figure 26 Installation of HardieBreak™ Thermal Strip for weatherboards and planks direct fixed



What are the accessories?



305532 HardieDrive™ Screws 40mm long

A class 3 finish self-tapping wing-tipped screw for fastening to 0.8mm to 1.6mm BTM steel frames.

Selling unit: 500 per box



305534 James Hardie™ Joint Sealant*

A general purpose, paintable, exterior grade polyurethane joint sealant.

Selling unit: 20 per box
300ml cartridge

* Not to be used in fire applications.

Artista[®] column



What is it?

A hollow column, with a smooth surface, that's available in a classic or tapered profile, and that can be coupled with various capitals and bases, and be site-painted or rendered to create a wide range of looks from classical to contemporary.

Where do you use it?

As an external or internal decorative or structural* feature around entrance ways, patios, pools and entertainment areas.

What are the key benefits?

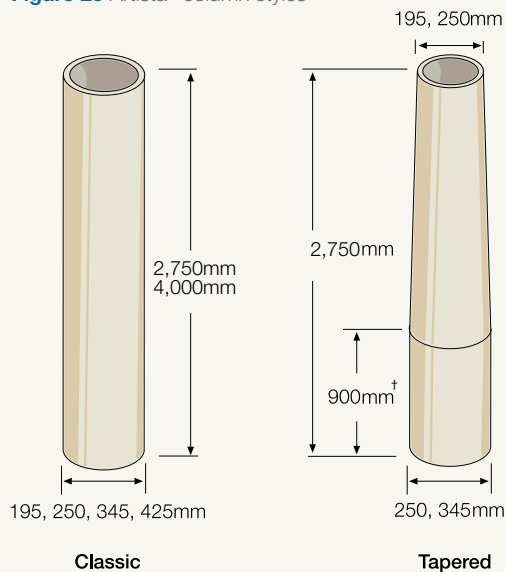
DESIGN FLEXIBILITY. The column and accessories come in a range of sizes and profiles for maximum design flexibility, and can be site-painted or rendered to create a variety of looks. To add to this, its hollow structure may be used to conceal unsightly services and structural posts.

FAST INSTALLATION. The column fixing bracket accessory makes retrofitting columns onto verandas easy. The process involves fixing the brackets to the floor and roof beam, jacking the roof up by 30mm, inserting the column and lowering the roof back onto the column.

VERSATILITY. They can be used in both load-bearing and non-load-bearing applications.* To add to this, some profiles can be joined end to end for extra height using the joining sleeve accessory.

SECURITY. Artista columns are resistant to damage from termites, rot and fire.* A 10-year product warranty gives peace of mind.

Figure 25 Artista[®] column styles



[†] Tapering in column begins 900mm from bottom.

* When installed and maintained correctly and to the extent set out in James Hardie's published literature current at the time of installation.

Note All dimensions and masses provided are approximate only and subject to manufacturing tolerances. Masses are based on equilibrium moisture content of product.

Artista® column

What are the sizes?

Artista® classic column

Product code	Nominal overall diameter (mm)	Nominal internal diameter (mm)	Stock length (m)	Mass (kg/lm)	Mass (kg)	Selling unit
402874	195	176	2.75	9.3	25.6	10 per pack or each
402873	195	176	4.0	9.3	37.2	10 per pack or each
402876	250	233	2.75	11.7	32.2	8 per pack or each
402875	250	233	4.0	11.7	46.8	8 per pack or each
400552	345	304	2.75	32.1	88.3	6 per pack or each
400550	345	304	4.0	32.1	128.4	6 per pack or each
400593	425	380	2.75	44	121	5 per pack or each
400591	425	380	4.0	44	176	5 per pack or each

Artista® tapered column

Product code	Nominal overall diameter at base (mm)	Nominal overall diameter at top (mm)	Nominal internal diameter at top (mm)	Stock length (m)	Mass (kg)	Selling unit
402882	250	195	176	2.75	82	8 per pack or each
402912	345	250	233	2.75	155	6 per pack or each

What are the accessories?

Bases and capitals

To suit column overall diameter **345mm** **425mm**

Flush



400568 Flush

Outside diameter: 311mm
Height: 80mm

400609 Flush

Outside diameter: 389mm
Height: 80mm

Rebate



400569 Rebate







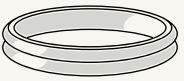





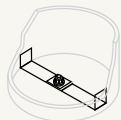
Outside diameter: 336mm
Height: 140mm

400610 Rebate

Outside diameter: 416mm
Height: 140mm

Note All dimensions and masses provided are approximate only and subject to manufacturing tolerances. Masses are based on equilibrium moisture content of product.

Artista® column

Bases and capitals				
To suit column overall diameter	195mm	250mm	345mm	425mm
Bell  	402867 Bell Outside diameter: 265mm Height: 35mm	402871 Bell Outside diameter: 336mm Height: 43mm		
Cove  	402868 Cove Outside diameter: 261mm Height: 54mm	402872 Cove Outside diameter: 350mm Height: 70mm		
Pencil Round  	402865 Pencil Round Outside diameter: 259mm Height: 60mm	402870 Pencil Round Outside diameter: 314mm Height: 60mm	400572 Pencil Round Outside diameter: 407mm Height: 60mm	400613 Pencil Round Outside diameter: 487mm Height: 60mm
Twin  	402860 Twin Outside diameter: 259mm Height: 55mm	402869 Twin Outside diameter: 314mm Height: 55mm		
Quad  	402850 Quad Outside diameter: 259mm Height: 30mm	402852 Quad Outside diameter: 314mm Height: 30mm		
Ornate  	402866 Ornate Outside diameter: 359mm Height: 95mm	402851 Ornate Outside diameter: 431mm Height: 95mm	400570 Ornate Outside diameter: 521mm Height: 95mm	400611 Ornate Outside diameter: 602mm Height: 95mm
Artista® Bracket				
To fit column	195 Classic & 250 Tapered	250 Classic & 345 Tapered		
	305577 Selling units per box: 20	305578 Selling units per box: 20	For information on how to fix columns of other diameters please contact James Hardie.	

Note All dimensions and masses provided are approximate only and subject to manufacturing tolerances. Masses are based on equilibrium moisture content of product.

HardieScreen™ lattice



What is it?

A decorative screen with either a square or diamond lattice pattern; it is site-painted.

Where do you use it?

On external structures like gazebos, verandas, fences and gable ends, or internal spaces, to create privacy, ventilation, shade, visual divides and design interest.

What are the key benefits?

DESIGN FLEXIBILITY. A range of looks can be achieved with either the square or the diamond lattice pattern, and it can be site-painted in a full range of exterior paint colours.

DURABILITY. Made from James Hardie fibre cement, HardieScreen lattice is extremely durable compared to timber. To add to this, there are no fasteners, which can rust and come apart over time in many timber products, to hold the pattern in place.

SECURITY. HardieScreen lattice is resistant to damage from termites, rot and fire.* A 10-year product warranty gives peace of mind.

What are the sizes?

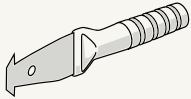
Product code	Profile	Length (mm)	Width (mm)	Thickness (mm)	Mass (kg/m ²)
400258	Square	2,400	1,200	6	7.7
400254	Diamond	2,400	1,200	6	7.7

Selling units per pack: 30 sheets or each

Note All dimensions and masses provided are approximate only and subject to manufacturing tolerances. Masses are based on equilibrium moisture content of product.
* When installed and maintained correctly and to the extent set out in James Hardie's published literature current at the time of installation.

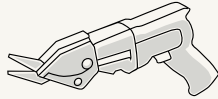
HardieScreen™ lattice

What are the accessories?



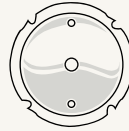
**305576 James Hardie™
Score and Snap Knife**

A tungsten tipped knife for scoring fibre cement sheets.
Selling unit: 20 per box



**300653 James Hardie™
Fibreshears**

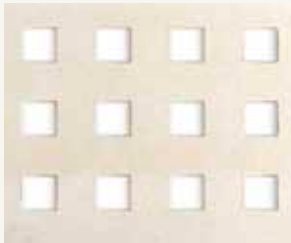
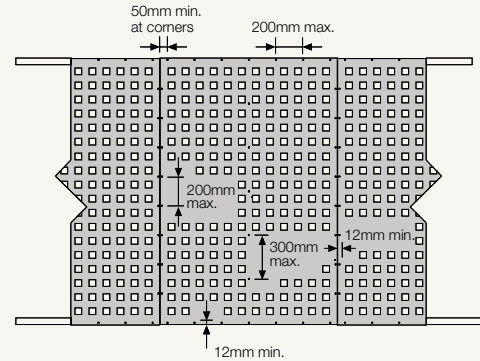
Electric tool for cutting fibre cement sheets.
Selling unit: 1 each



**300660/303375
HardieBlade™ Saw Blade**

A poly-diamond blade for fast and clean cutting of James Hardie fibre cement.
Selling unit: 1 Each
Diameter: 185mm/254mm

Figure 27w HardieScreen™ lattice fastener layout



**HardieScreen™
lattice**
profile showing square
pattern.



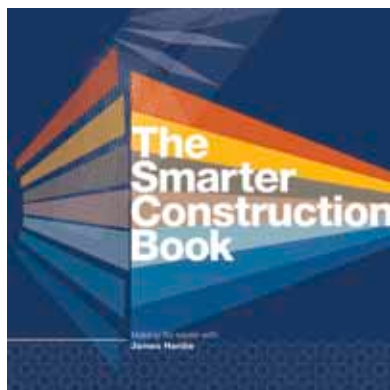
**HardieScreen™
lattice**
profile showing
diamond pattern.

A smarter way to build

James Hardie has developed a series of books to showcase better ways of designing and building Australian houses.

The books are available on our website www.jameshardie.com.au

Or call 13 11 03 and we'll send you a complimentary copy



scyon™

The looks and the brains

STRIA™

CLADDING

A wide cladding board, with a 15mm horizontal joint that has the classic appeal of decorative render. Pre-primed and easy to install, it is the fast way to achieve a timeless look. For residential applications.

MATRIX™

CLADDING

An exterior cladding system with a geometric, expressed-joint look. Fast and simple to install, it creates the commercial look without the price tag. For residential and medium-density applications.



SECURA™

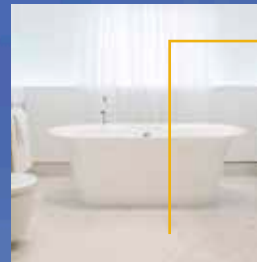
EXTERIOR FLOORING

An external structural flooring substrate for tile finishes over timber or lightweight steel floor joists. Simple and fast to install, it helps give you peace of mind against moisture damage to balconies. For tiled residential balconies.

LINEA™

WEATHERBOARD

A 16mm thick horizontal weatherboard, with deep shadow lines, that has the look of a traditional weatherboard without weathering like one. For residential applications.



SECURA™

INTERIOR FLOORING

A heavy-duty but lightweight structural flooring substrate that does double duty. It can be easily used for tile, vinyl and carpet finishes over timber or steel floor joists in both residential general interiors and wet areas as an alternative to particleboard, plywood or compressed fibre cement. Simple and fast to install, it's the easiest way to get top protection against moisture damage in all interior floors.

AXON™

CLADDING

A vertically grooved cladding panel that looks sharp and smooth. Pre-primed and easy to install, it creates a pristine look that lasts. For residential applications.

Smarter building begins before a single hammer is lifted. It starts from the moment the building materials are designed and produced. The culmination of years of innovative research and development, Scyon's™ resilient makeup challenges conventional building methods in a range of steadfast products. This new generation of sustainable building products feature the advanced cement composite Scyon™, ingeniously combining workability and durability with artful simplicity.

James Hardie™ are committed to the sustainable production of building materials for a tougher and greener tomorrow.

Visit scyon.com.au for more details

Ask James Hardie™
Call 13 11 03
www.jameshardie.com.au

© 2012 James Hardie Australia Pty Ltd ABN 12 084 635 559

™ and ® denotes a trademark or registered mark owned by James Hardie Technology Limited.