

ozito

HEDGE TRIMMER

550W 450mm

INSTRUCTION MANUAL

SPECIFICATIONS

| | |
|------------------------|-----------------|
| Input: | 230-240V ~ 50Hz |
| Motor: | 550W |
| No Load Speed: | 1,400/min |
| Blade Length: | 450mm |
| Max. Cutting Capacity: | 16mm |
| Weight: | 2.9kg |

ozito.com.au

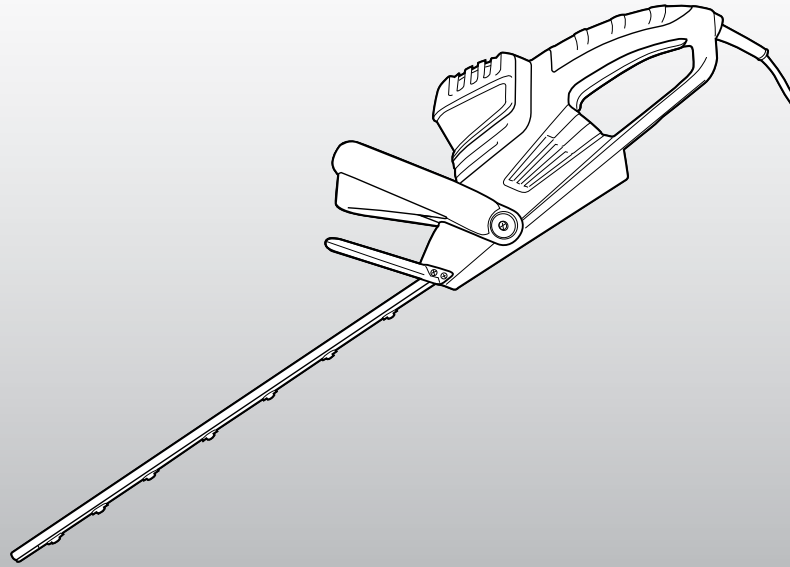

WHAT'S IN THE BOX

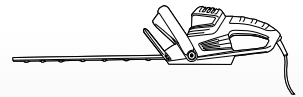

Hedge Trimmer



Blade Cover

3 YEAR REPLACEMENT WARRANTY

HTE-550

WARRANTY

IN ORDER TO MAKE A CLAIM UNDER THIS WARRANTY YOU MUST RETURN THE PRODUCT TO YOUR NEAREST BUNNINGS WAREHOUSE WITH YOUR BUNNINGS REGISTER RECEIPT. PRIOR TO RETURNING YOUR PRODUCT FOR WARRANTY PLEASE TELEPHONE OUR CUSTOMER SERVICE HELPLINE:

Australia 1800 069 486

New Zealand 0508 069 486

TO ENSURE A SPEEDY RESPONSE PLEASE HAVE THE MODEL NUMBER AND DATE OF PURCHASE AVAILABLE. A CUSTOMER SERVICE REPRESENTATIVE WILL TAKE YOUR CALL AND ANSWER ANY QUESTIONS YOU MAY HAVE RELATING TO THE WARRANTY POLICY OR PROCEDURE.

The benefits provided under this warranty are in addition to other rights and remedies which are available to you at law.

Our goods come with guarantees that cannot be excluded at law. You are entitled to a replacement or refund for a major failure and for compensation for any other reasonably foreseeable loss or damage. You are also entitled to have the goods repaired or replaced if the goods fail to be of acceptable quality and the failure does not amount to a major failure.

Generally you will be responsible for all costs associated with a claim under this warranty, however, where you have suffered any additional direct loss as a result of a defective product you may be able to claim such expenses by contacting our customer service helpline above.

3 YEAR REPLACEMENT WARRANTY

Your product is guaranteed for a period of **36 months from the original date of purchase** and is intended for DIY (Do It Yourself) use only. If a product is defective it will be replaced in accordance with the terms of this warranty. Warranty excludes consumable parts, for example: carbon brushes, etc.

WARNING

The following actions will result in the warranty being void.

- If the tool has been operated on a supply voltage other than that specified on the tool.
- If the tool shows signs of damage or defects caused by or resulting from abuse, accidents or alterations.
- Failure to perform maintenance as set out within the instruction manual.
- If the tool is disassembled or tampered with in any way.
- Professional, industrial or high frequency use.

KNOW YOUR PRODUCT

HEDGE TRIMMER

- | | |
|-----------------|-----------------|
| 1 Cutting Blade | 5 Cord Retainer |
| 2 Safety Guard | 6 On/Off Switch |
| 3 Safety Switch | 7 Rear Handle |
| 4 Front Handle | 8 Power Cord |

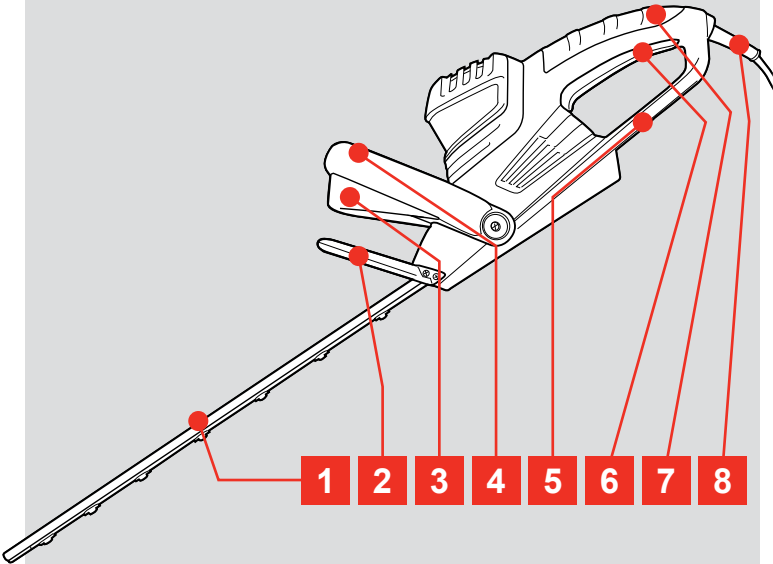

ACCESSORIES:

- 9 Blade Cover

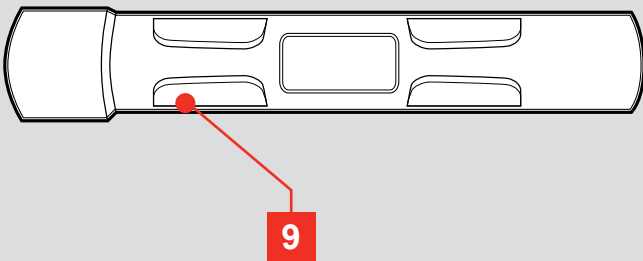

ONLINE MANUAL

Scan this QR Code with your mobile device to take you to the online manual.



PREPARATION

1. BLADE COVER



WARNING! ENSURE THE HEDGE TRIMMER IS DISCONNECTED FROM THE POWER SUPPLY BEFORE REMOVING COVER AND PREPARING FOR USE.

Fitting and Removing the Blade Cover

The hedge trimmer comes with a blade cover to protect the blades when storing. The blade cover must be removed prior to operation.

- 1 Slide the blade cover off the blade.

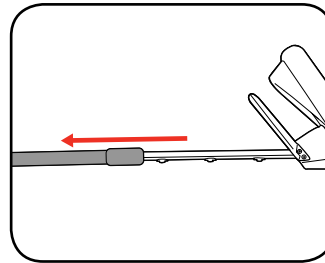

- 2 To fit, slide the cover back over the blade.

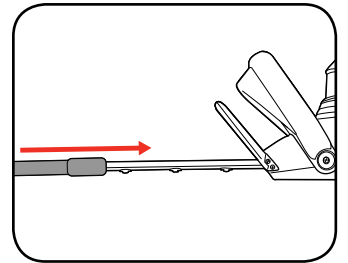

WARNING! NEVER USE THE HEDGE TRIMMER WITH THE BLADE COVER FITTED.

3 YEAR REPLACEMENT WARRANTY

2. CORD RETAINER

Using the Cord Retainer

NOTE: TO AVOID THE EXTENSION CORD FROM DETACHING; ALWAYS CHECK THAT THE CORD IS ATTACHED TO THE CORD RETAINER BEFORE USE.

- 1 Make a loop with the extension cord and push it through the hole under the on/off switch.
- 2 Place the loop onto the cord retainer and ensure it is pulled firmly into place.

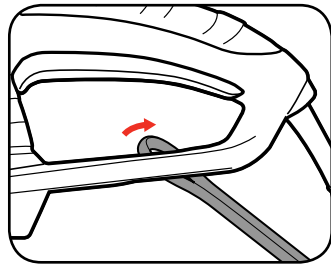
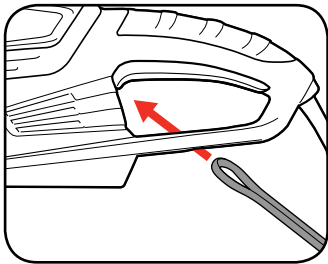

- 3 Connect the extension cord socket to the hedge trimmer power cord.

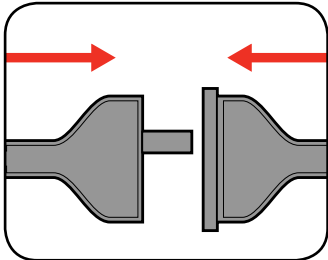

Using an extension lead

Always use an approved extension lead suitable for the power input of this tool. Before use, inspect the extension lead for signs of damage, wear and ageing. Replace the extension lead if damaged or defective. When using an extension lead on a reel, always unwind the lead completely. Use of an extension lead not suitable for the power input of the tool or which is damaged or defective may result in a risk of fire and electric shock.

3. CHECKS PRIOR TO OPERATION



WARNING! ENSURE THE HEDGE TRIMMER IS DISCONNECTED FROM THE POWER SUPPLY BEFORE PERFORMING ANY OF THE FOLLOWING OPERATIONS.

Before Using the Hedge Trimmer

- 1 Check that the blades are not damaged. If so the blades will need to be replaced.
- 2 Make sure that the safety guard is attached securely.

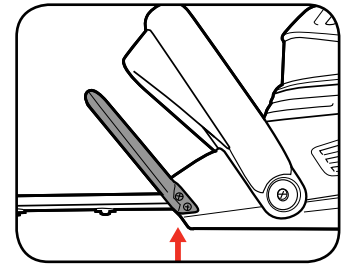
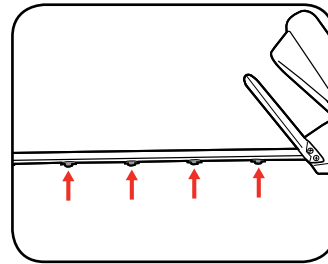

- 3 Check that the extension cord is positioned in the cord retainer firmly.

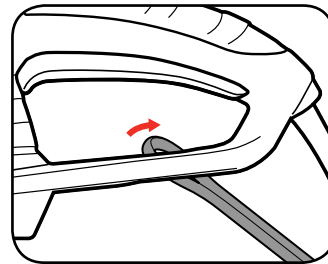

WARNING: MAKE SURE THAT THE WORK AREA IS FREE OF ROCKS, DEBRIS, LINES AND OTHER FOREIGN OBJECTS.

OPERATION

4. CONTROLS

CAUTION: TO REDUCE THE RISK OF ELECTRICAL SHOCK, WE RECOMMEND THE USE OF A RESIDUAL CURRENT DEVICE (RATED 30MA OR LESS).

On/Off Switch

For user safety the safety switch and on/off switch must be operated simultaneously.

- 1 Using one hand depress and hold the safety switch on the front handle.
- 2 To turn on squeeze the on/off switch.

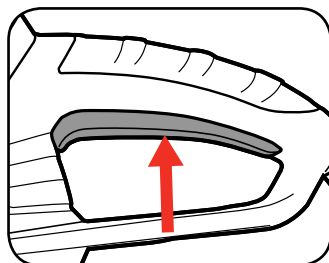
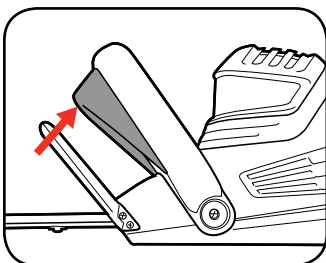

- 3 Once either the safety switch or on/off switch is released the hedge trimmer will slow to a stop.

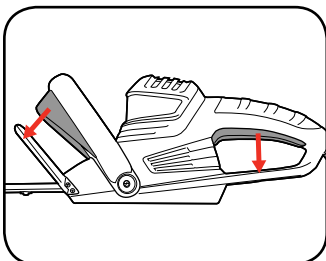

WARNING: THE HEDGE TRIMMER MAY RUN FOR A FEW SECONDS AFTER IT HAS BEEN SWITCHED OFF. LET THE MOTOR COME TO A COMPLETE STANDSTILL BEFORE SETTING THE TOOL DOWN.

WARNING: ALWAYS USE THE HEDGE TRIMMER WITH BOTH HANDS.

5. USING THE HEDGE TRIMMER

Using the Hedge Trimmer

1. Ensure the extension cord is behind the trimmer and away from operation.
2. Maintain proper footing and balance. Do not overreach.

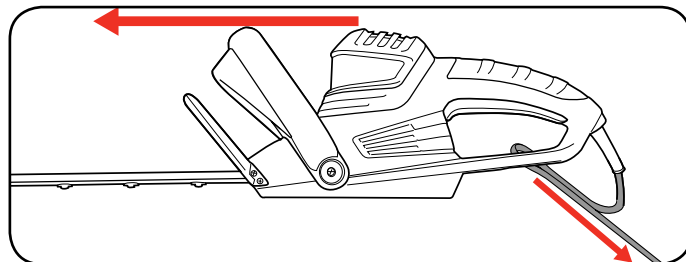

3. Squeeze both the safety switch and the on/off switch to start the trimmer.
4. Use wide sweeping motions, feeding the blade teeth through the twigs.

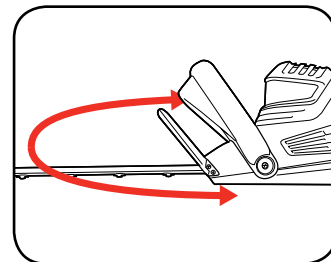
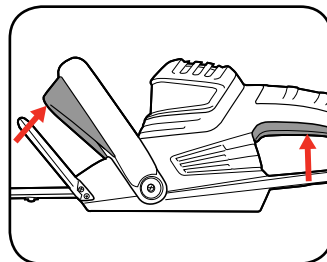

5. A slight downward tilt will achieve the best results.
6. For trimming sides, begin at the bottom and sweep up.

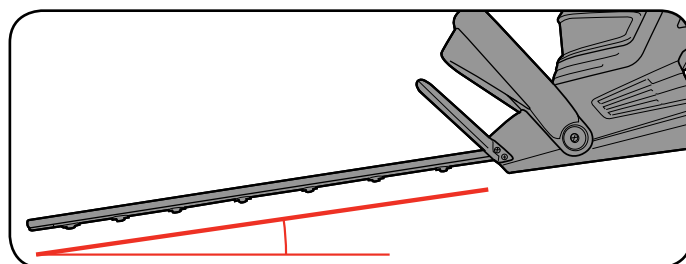

NOTE: DO NOT CUT HEDGES WHEN WET. (THE BEST RESULTS ARE ACHIEVED WHEN DRY.)

MAINTENANCE



WARNING! ENSURE THE HEDGE TRIMMER IS DISCONNECTED FROM THE POWER SUPPLY BEFORE PERFORMING ANY OF THE FOLLOWING OPERATIONS.

- When not in use, the Hedge Trimmer should be stored in a dry, frost free location not within the reach of children.
- Keep ventilation slots of the Hedge Trimmer clean at all times and prevent any foreign matter from entering.
- If the enclosure of the Hedge Trimmer requires cleaning do not use solvents but a moist cloth only.
- There are no user serviceable parts in the Hedge Trimmer; if a fault is suspected or the supply cord requires replacement, return the Trimmer to a power tool repairer.
- The blade rail should be cleaned and treated with light machine oil or spray lubricant (such as WD40, CRC 5.56 or RP7) after each use. When a job lasts for a longer period of time it is recommended that the blade rail also be treated with spray lubricant at regular intervals during operation.

Carbon Brushes

When the carbon brushes wear out, the hedge trimmer will spark and/or stop. Discontinue use as soon as this happens. They should be replaced prior to recommencing use of the hedge trimmer. Carbon brushes are a wearing component of the hedge trimmer therefore not covered under warranty. Continuing to use the hedge trimmer when carbon brushes need to be replaced may cause permanent damage to the hedge trimmer. Carbon brushes will wear out after many uses but when the carbon brushes need to be replaced, take the hedge trimmer to an electrician or a power tool repairer for a quick and low cost replacement. Always replace both carbon brushes at the same time.



recommencing use of the hedge trimmer. Carbon brushes are a wearing component of the hedge trimmer therefore not covered under warranty. Continuing to use the hedge trimmer when carbon brushes need to be replaced may cause permanent damage to the hedge trimmer. Carbon brushes will wear out after many uses but when the carbon brushes need to be replaced, take the hedge trimmer to an electrician or a power tool repairer for a quick and low cost replacement. Always replace both carbon brushes at the same time.

to an electrician or a power tool repairer for a quick and low cost replacement. Always replace both carbon brushes at the same time.

Note: Ozito Industries will not be responsible for any damage or injuries caused by the repair of the hedge trimmer by an unauthorised person or by mishandling of the hedge trimmer. This tool is designed for DIY use - use in commercial or industrial environments will void the warranty.

CARING FOR THE ENVIRONMENT



Power tools that are no longer usable should not be disposed of with household waste but in an environmentally friendly way. Please recycle where facilities exist. Check with your local council authority for recycling advice.



Recycling packaging reduces the need for landfill and raw materials. Reuse of recycled material decreases pollution in the environment. Please recycle packaging where facilities exist. Check with your local council authority for recycling advice.

DESCRIPTION OF SYMBOLS

| | | | |
|------|---|----------------|----------------------------|
| V | Volts | Hz | Hertz |
| ~ | Alternating current | W | Watts |
| /min | Revolutions or reciprocation per minute | n ₀ | No load speed |
| | Double insulated | | Regulator compliance mark |
| | Warning | | Read instruction manual |
| | Wear eye protection | | Do not operate in the rain |
| | Danger flying objects | | |
| | Disconnect the mains plug if the cord is damaged or entangled | | Decibel level |

TROUBLESHOOTING

| Problem | Cause | Remedy |
|--|----------------------------------|--|
| Blades are not cutting smoothly. | Blades could be worn or damaged | Contact customer service. |
| Excessive sparking visible through air vents | Carbon brushes may have worn out | Replace carbon brushes as per maintenance section. |

SPARE PARTS

| | |
|---------------------|-------------|
| Blade Cover | SPHTE550-54 |
| Carbon Brush (Pair) | SPHTE550-34 |
| Brush Holder (Pair) | SPHTE550-32 |
| Blade | SPHTE550-56 |

Spare parts can be ordered from the Special Orders Desk at your local Bunnings Warehouse.

For further information, or any parts not listed here, visit

www.ozito.com.au or contact Ozito Customer Service:

Australia 1800 069 486

New Zealand 0508 069 486

E-mail: enquires@ozito.com.au

ELECTRICAL SAFETY

 **WARNING!** When using mains-powered tools, basic safety precautions, including the following, should always be followed to reduce risk of fire, electric shock, personal injury and material damage.

Read the whole manual carefully and make sure you know how to switch the tool off in an emergency, before operating the tool.

Save these instructions and other documents supplied with this tool for future reference.

The electric motor has been designed for 230V and 240V only. Always check that the power supply corresponds to the voltage on the rating plate.

Note: The supply of 230V and 240V on Ozito tools are interchangeable for Australia and New Zealand.



This tool is double insulated in accordance with AS/NZS 60745.1; therefore no earth wire is required.

To reduce the risk of electrical shock, we recommend the use of a residual current device (rated 30mA or less).

If the supply cord is damaged, it must be replaced by an electrician or a power tool repairer in order to avoid a hazard.

Note: Double insulation does not take the place of normal safety precautions when operating this tool. The insulation system is for added protection against injury resulting from a possible electrical insulation failure within the tool.

Using an Extension Lead

Always use an approved extension lead suitable for the power input of this tool. Before use, inspect the extension lead for signs of damage, wear and ageing. Replace the extension lead if damaged or defective.

When using an extension lead on a reel, always unwind the lead completely. Use of an extension lead not suitable for the power input of the tool or which is damaged or defective may result in a risk of fire and electric shock.

Supply cords shall not be lighter than:

- if rubber insulated, ordinary tough rubber sheathed flexible cord (code designation 60245 IEC 53);

- if polyvinyl chloride insulated, ordinary polyvinyl chloride sheathed flexible cord (code designation 60227 IEC 53).

GENERAL POWER TOOL SAFETY WARNINGS

 **WARNING!** Read all safety warnings and all instructions. Failure to follow the warnings and instructions may result in electric shock, fire and/or serious injury.

Save all warnings and instructions for future reference. The term "power tool" in the warnings refers to your mains-operated (corded) power tool or battery-operated (cordless) power tool.

1. Work area safety

- Keep work area clean and well lit. Cluttered or dark areas invite accidents.
- Do not operate power tools in explosive atmospheres, such as in the presence of flammable liquids, gases or dust. Power tools create sparks which may ignite the dust or fumes.
- Keep children and bystanders away while operating a power tool. Distractions can cause you to lose control.

2. Electrical safety

- Power tool plugs must match the outlet. Never modify the plug in any way. Do not use any adapter plugs with earthed (grounded) power tools. Unmodified plugs and matching outlets will reduce risk of electric shock.
- Avoid body contact with earthed or grounded surfaces, such as pipes, radiators, ranges and refrigerators. There is an increased risk of electric shock if your body is earthed or grounded.
- Do not expose power tools to rain or wet conditions. Water entering a power tool will increase the risk of electric shock.
- Do not abuse the cord. Never use the cord for carrying, pulling or unplugging the power tool. Keep cord away from heat, oil, sharp edges or moving parts. Damaged or entangled cords increase the risk of electric shock.
- When operating a power tool outdoors, use an extension cord suitable for outdoor use. Use of a cord suitable for outdoor use reduces the risk of electric shock.
- If operating a power tool in a damp location is unavoidable, use a residual current device (RCD) protected supply. Use of an RCD reduces the risk of electric shock.

3. Personal safety

- Stay alert, watch what you are doing and use common sense when operating a power tool. Do not use a power tool while you are tired or under the influence of drugs, alcohol or medication. A moment of inattention while operating power tools may result in serious personal injury.
- Use personal protective equipment. Always wear eye protection. Protective equipment such as dust mask, non-skid safety shoes, hard hat, or hearing protection used for appropriate conditions will reduce personal injuries.
- Prevent unintentional starting. Ensure the switch is in the off-position before connecting to power source and/or battery pack, picking up or carrying the tool. Carrying power tools with your finger on the switch or energising power tools that have the switch on invites accidents.

- Remove any adjusting key or wrench before turning the power tool on. A wrench or a key left attached to a rotating part of the power tool may result in personal injury.
 - Do not overreach. Keep proper footing and balance at all times. This enables better control of the power tool in unexpected situations.
 - Dress properly. Do not wear loose clothing or jewellery. Keep your hair, clothing and gloves away from moving parts. Loose clothes, jewellery or long hair can be caught in moving parts.
 - If devices are provided for the connection of dust extraction and collection facilities, ensure these are connected and properly used. Use of dust collection can reduce dust-related hazards.
- ## 4. Power tool use and care
- Do not force the power tool. Use the correct power tool for your application. The correct power tool will do the job better and safer at the rate for which it was designed.
 - Do not use the power tool if the switch does not turn it on and off. Any power tool that cannot be controlled with the switch is dangerous and must be repaired.
 - Disconnect the plug from the power source and/or the battery pack from the power tool before making any adjustments, changing accessories, or storing power tools. Such preventive safety measures reduce the risk of starting the power tool accidentally.
 - Store idle power tools out of the reach of children and do not allow persons unfamiliar with the power tool or these instructions to operate the power tool. Power tools are dangerous in the hands of untrained users.
 - Maintain power tools. Check for misalignment or binding of moving parts, breakage of parts and any other condition that may affect the power tool's operation. If damaged, have the power tool repaired before use. Many accidents are caused by poorly maintained power tools.
 - Keep cutting tools sharp and clean. Properly maintained cutting tools with sharp cutting edges are less likely to bind and are easier to control.
 - Use the power tool, accessories and tool bits etc. in accordance with these instructions, taking into account the working conditions and the work to be performed. Use of the power tool for operations different from those intended could result in a hazardous situation.
- ## 5. Service
- Have your power tool serviced by a qualified repair person using only identical replacement parts. This will ensure that the safety of the power tool is maintained.
 - If the supply cord is damaged, it must be replaced by the manufacturer, its service agent or similarly qualified persons in order to avoid the hazard.

HEDGE TRIMMER SAFETY WARNINGS

- Keep all parts of the body away from the cutter blade. Do not remove cut material or hold material to be cut when blades are moving. Make sure the switch is off when clearing jammed material. A moment of inattention while operating the hedge trimmer may result in serious personal injury.
 - Carry the hedge trimmer by the handle with the cutter blade stopped. When transporting or storing the hedge trimmer always fit the cutting device cover. Proper handling of the hedge trimmer will reduce possible personal injury from the cutter blades.
 - Hold the power tool by insulated gripping surfaces only, because the cutter blade may contact hidden wiring or its own cord. Cutter blades contacting a "live" wire may make exposed metal parts of the power tool "live" and could give the operator an electric shock.
 - Keep cable away from cutting area. During operation the cable may be hidden in shrubs and can be accidentally cut by the blade.
 - Perform visual inspection on the hedge being trimmed. To ensure no wire fences or foreign objects that the hedge trimmer may contact during operation.
- This appliance is not intended for use by persons (including children) with reduced physical, sensory or mental capabilities, or lack of experience and knowledge, unless they have been given supervision or instruction concerning use of the appliance by a person responsible for their safety.

Using an Extension Lead

Always use an approved extension lead suitable for the power input of this tool.

Before use, inspect the extension lead for signs of damage, wear and ageing.

Replace the extension lead if damaged or defective.

When using an extension lead on a reel, always unwind the lead completely. Use of an extension lead not suitable for the power input of the tool or which is damaged or defective may result in a risk of fire and electric shock.

Before use check the supply and extension cord for signs of damage or aging.

If the cord becomes damaged during use, disconnect the cord from the supply

immediately. DO NOT TOUCH THE CORD BEFORE DISCONNECTING THE SUPPLY. Do not use the Hedge Trimmer if the cord is damaged or worn.

- Keep extension cord away from cutting blades.

- Never allow children or people unfamiliar with these instructions to use the Hedge Trimmer.
- Avoid using the Hedge Trimmer, while people, especially children or pets, are nearby.
- Never operate the Hedge Trimmer with damaged guards or without guards in place.
- Switch on the Hedge Trimmer only when the hands and feet are away from the cutting blades.
- Use only the manufacturer's recommended replacement parts and accessories.
- Always disconnect the Hedge Trimmer from the mains when leaving the Hedge Trimmer unattended.
- Disconnect the Hedge Trimmer from the mains before carrying out maintenance or cleaning work.
- When not in use, store the Hedge Trimmer out of the reach of children.
- Face the cutting blades away from yourself, other people and animals while the power is connected to the Hedge Trimmer (especially during operation).
- Disconnect the power from the Hedge Trimmer before making any adjustments.
- Use both handles.
- Keep ventilation openings clear of debris. Keep handles dry, clean and free of oil and grease.
- Never reach underneath the Hedge Trimmer (the cutting blade area) until it has completely stopped and the power has been disconnected.