

Installation Instructions

IMPORTANT NOTES

- Failure to install, finish or maintain this product in accordance with applicable building codes, regulations, standards and James Hardie's written application instructions may lead to personal injury, affect system performance, violate local building codes, and void James Hardie's product warranty.
- All warranties, conditions, liabilities (direct, indirect or consequential) and obligations whether arising in contract, tort or otherwise other than those specified in James Hardie's product warranty are excluded to the fullest extent allowed by law. For James Hardie's product warranty information and disclaimers about the information in this manual, see the section at the end of this manual.
- The builder must ensure the product meets aesthetic requirements before installation. James Hardie will not be responsible for rectifying aesthetic surface variations following installation.
- Make sure your information is up to date. When specifying or installing James Hardie® products, ensure you have the current manual. If in doubt, or you need more information, visit www.jameshardie.com.au or Ask James Hardie™ on 13 11 03.

SCYON™ AXON™ CLADDING SHEET SIZES (mm)

Pre-primed with vertical grooves. There is a ship lap edge joint along the two long edges and square edges along the short edges. The grooves are nominally 2mm deep and 10mm wide. Sheet weighs approximately 12kg/m² in equilibrium.

Scyon™ Axon™ cladding 133 Smooth	LENGTH	WIDTH	THICKNESS	MASS (kg)	SHEETS PER PACK	PRODUCT CODE
	2450	1200	9	36	30	403931
	2750	1200	9	40	30	403932
	3000	1200	9	44	30	403933
Scyon™ Axon™ cladding 133 Grained	2450	1200	9	36	30	404510
	2750	1200	9	40	30	404511
	3000	1200	9	44	30	404512
Grooves at 133mm centres						
Scyon™ Axon™ cladding 400 Smooth	2450	1200	9	36	30	404417
	2750	1200	9	40	30	404418
	3000	1200	9	44	30	404419
Grooves at 400mm centres						

*All dimensions and masses are approximate and subject to manufacture tolerances.

WARNING
DO NOT BREATHE DUST AND CUT ONLY IN WELL VENTILATED AREA

James Hardie products contain sand, a source of respirable crystalline silica which is considered by some international authorities to be a cause of cancer from some occupational sources. Breathing excessive amounts of respirable silica dust can also cause a disabling and potentially fatal lung disease called silicosis, and has been linked with other diseases. Some studies suggest smoking may increase these risks. During installation or handling:

- work in outdoor areas with ample ventilation;
- minimise dust when cutting by using either 'score and snap' knife, fibre cement shears or, where not feasible, use a HardieBlade® saw blade and dust reducing circular saw attached to a HEPA vacuum;
- warn others in the immediate area to avoid breathing dust;
- wear a properly-fitted, approved dust mask or respirator (e.g. P1 or P2) in accordance with applicable government regulations and manufacturer instructions to further limit respirable silica exposures. During clean-up, use HEPA vacuums or wet cleanup methods - never dry sweep. For further information, refer to our installation instructions and Material Safety Data Sheets available at www.jameshardie.com.au. FAILURE TO ADHERE TO OUR WARNINGS, MATERIAL SAFETY DATA SHEETS, AND INSTALLATION INSTRUCTIONS MAY LEAD TO SERIOUS PERSONAL INJURY OR DEATH.

JAMES HARDIE RECOMMENDED SAFE WORKING PRACTICES
CUTTING OUTDOORS

- Position cutting station so wind will blow dust away from the user or others in working area.
- Use one of the following methods based on the required cutting rate:
 - Best** • Score and snap • Hand guillotine • Fibreshear
 - Better** • Dust reducing circular saw equipped with HardieBlade® Saw blade and HEPA vacuum extraction.
 - Good** • Dust reducing circular saw equipped with HardieBlade® saw blade.

CUTTING INDOORS

- Cut only using score and snap, hand guillotine or fibreshears (manual, electric or pneumatic).
- Position cutting station in a well-ventilated area.

DRILLING/OTHER MACHINING

When drilling or machining you should always wear a P1 or P2 dust mask and warn others in the immediate area.

IMPORTANT NOTES

- For maximum protection (lowest respirable dust production), James Hardie recommends always using "Best" - level cutting methods where feasible.
- NEVER use a power saw indoors.
- NEVER use a circular saw blade that does not carry the HardieBlade® logo.
- NEVER dry sweep - Use wet suppression or HEPA vacuum.
- NEVER use grinders.
- ALWAYS follow tool manufacturers' safety recommendations.

P1 or P2 respirators should be used in conjunction with above cutting practices to further reduce dust exposures. Additional exposure information is available at www.jameshardie.com.au to help you determine the most appropriate cutting method for your job requirements. If concern still exists about exposure levels or you do not comply with the above practices, you should always consult a qualified industrial hygienist or contact James Hardie for further information.

STORAGE AND HANDLING

To avoid damage, all James Hardie building products should be stored with edges and corners of the product protected from chipping. James Hardie building products must be installed in a dry state and protected from weather during transport and storage. The product must be laid flat under cover on a smooth level surface clear of the ground to avoid exposure to water, moisture, etc.

ACCESSORIES / TOOLS SUPPLIED BY JAMES HARDIE

ACCESSORIES	DESCRIPTION	QUANTITY
	HardieDrive™ Screw 40mm Long A class 3 finish self-tapping wing-tipped screw for fastening to 0.8mm to 1.6mm BMT steel frames. Part No. 305532	500 per box
	James Hardie™ 50mm wide Foam Back Sealing Tape. 25mtr long roll A self-adhesive foam tape to help improve water tightness with EasyLap™ panel and Scyon™ Axon™ cladding. It is applied under sheet joints to the HardieWrap™ Weather Barrier along the stud face. Part No. 304560	1 each
	James Hardie™ Joint Sealant General purpose, paintable, exterior grade polyurethane joint sealant. 300ml cartridge/600ml sausage. Part No. 305534/305672	20 per box
	James Hardie™ Aluminium Snap on Corner. 3,000mm long (2 pieces per set) A ready to paint aluminium extrusion set, to be used with Scyon™ Axon™ cladding, HardiePlank™ weatherboard and PrimeLine™ weatherboard, at internal and external corner junctions to conceal the board edge. Before inserting outer piece, use pliers to break off teeth along score line. Part No. 305513	5 sets per pack
	James Hardie™ 9mm Aluminium Internal Corner. 3,000mm long A ready to paint aluminium extrusion, to be used with EasyLap™ panel and Scyon™ Axon™ cladding, at internal corner junctions to conceal the board edge. Part No. 305520	5 per pack
	James Hardie™ 9mm Aluminium External Corner. 3,000mm long A ready to paint aluminium extrusion, to be used with EasyLap™ panel and Scyon™ Axon™ cladding, at external corner junctions to conceal the board edge. Part No. 305521	5 per pack
	James Hardie™ 75x75mm Colorbond® Corner Flashing. 3,000mm long A Colorbond® corner flashing for use behind cladding at internal and external corners. Part No. 305564	5 per pack
	James Hardie™ 9mm Aluminium Horizontal Flashing. 3,000mm long A ready to paint aluminium horizontal flashing, to be used with EasyLap™ panel and Scyon™ Axon™ cladding, for horizontal control joints. Part No. 305613	5 per pack
	James Hardie™ 9mm Aluminium Horizontal Joinder A ready to paint aluminium joinder, used to join the James Hardie™ 9mm Aluminium Horizontal Flashing. Part No. 305614	10 per pack
	HardieBreak™ thermal strip A building code requirement and is installed behind James Hardie external cladding over metal framing and HardieWrap™ Weather Barrier. Refer to HardieBreak thermal strip installation guide. Unit size 43 x 12 x 2750mm. Part No. 305612	45 per pack
	HardieWrap™ Weather Barrier A non-perforated, highly breathable and reflective safe-glare weather barrier designed to be used behind Scyon™ external cladding products to help protect the building. For alternate products, please refer to HardieWrap™ weather barrier section (p.2) Unit size 2750mm x 3000mm Part No. 305664.	
TOOLS		
	HardieBlade™ Saw Blade. 185mm diameter A 185mm diameter poly-diamond blade for fast and clean cutting of James Hardie fibre cement. Part No. 300660	1 each

ACCESSORIES / TOOLS NOT SUPPLIED BY JAMES HARDIE

James Hardie recommends the following products for use in conjunction with the Scyon™ Axon™ cladding. James Hardie does not supply these products. Please contact the component manufacturer for information on their warranties and further information on their products.

PRODUCT	DESCRIPTION	PRODUCT	DESCRIPTION
	Dust-reducing saw Dust reducing saw with a HardieBlade® saw blade Makita 5057KB Hitachi C7YA		Vacuum extraction with HEPA filter Used with HEPA filter and paper bag for reduced dust exposure
	Buildex FibreTEK® 40mm long for fixing Scyon Axon sheets into steel frames of 0.55mm to 0.75mm BMT.		Fibre cement nails 2.8 x 40mm min. class 3 fibre cement nail ND 50mm stainless steel brad nail 14 gauge x 50mm ND 304 stainless steel nail. Suitable only for N1, N2, N3, & C1

SCOPE

General

This manual covers the use of the Scyon™ Axon™ cladding in a residential facade application over a seasoned timber wall frame or a light-gauge steel frame.

DESIGN

General

All design and construction must comply with the appropriate requirements of the current Building Code of Australia (BCA) and other applicable regulations and standards.

Responsibility

The specifier or other party responsible for the project must ensure that the details in this specification are appropriate for the intended application and that additional detailing is performed for specific design or any areas that fall outside the scope of this specification.

Slab and footings

The slab and footings on which the building is situated must comply with AS 2870 'Residential slabs and footings – Construction' and the requirements of the Building Code of Australia (BCA).

Ground clearances

Install James Hardie external cladding with a minimum 150mm clearance to the earth on the exterior of the building or in accordance with local building codes if greater than 150mm is required. Maintain a minimum 50mm clearance between James Hardie external cladding and roofs, decks, paths, steps and driveways.

Adjacent finished grade must slope away from the building in accordance with local building codes, typically a minimum slope of 50mm minimum over the first metre.

Do not install external cladding such that it may remain in contact with standing water.

NOTE: Greater clearance may be required in order to comply with termite protection provisions, see below for more information.

Termite Protection

The BCA specifies the requirements for termite barriers. Where the exposed slab edge is used as part of the termite barrier system, a minimum of 75mm of the exposed slab edge must be visible to permit ready detection of termite entry.

Structural bracing

Scyon™ Axon™ cladding can be installed to provide wall bracing against lateral forces due to wind. For further information, Ask James Hardie™ on 13 11 03.

Fire rated walls

Scyon™ Axon™ cladding can achieve fire ratings of 60/60/60 and 90/90/90 when constructed with additional fire rated linings as specified in the James Hardie fire and acoustically rated walls design manual and construction of fire and acoustically rated walls technical specification.

MOISTURE MANAGEMENT

General

It is the responsibility of designer or specifier to identify moisture related risks associated with any particular building design. Wall construction design must effectively manage moisture, accounting for both the interior and exterior environments of the building, particularly in buildings that have a higher risk of wind driven rain penetration or that are artificially heated or cooled.

In addition all wall openings, penetrations, junctions, connections, window sills, heads and jambs must incorporate appropriate flashing and waterproofing. Materials, components and their installation that are used to manage moisture in framed wall construction must, at a minimum, comply with the requirements of relevant standards and the BCA.

HardieWrap™ weather barrier

HardieWrap™ weather barrier must be installed under Scyon™ Axon™ cladding in accordance with the AS/NZS 4200.2 'Pliable building membranes and underlays – Installation' and HardieWrap™ Technical Data Sheet.

HardieWrap™ weather barrier delivers a triple-shield of protection to help against external weather penetration, internal condensation build-up and external heat penetration. Additionally, it enhances the wall thermal performance, please refer to www.jameshardie.com.au or www.accel.com.au for more information.

If using an alternate product in lieu of HardieWrap™ weather barrier, the designer must ensure that the product is fit for purpose and it has the following properties in accordance with AS/NZS 4200.1:

- Vapour barrier - low or medium
- Water barrier - high

In hot humid areas of Australia, HardieWrap™ weather barrier may not be suitable, refer to the building designer for a suitable membrane and Ask James Hardie™ on 13 11 03.

Soft compressible insulation installed between the front of the wall studs and directly behind the external cladding can cause installation issues and is thus not recommended.

Flashing

All wall openings, penetrations, intersections, connections, window sills, heads and jambs must be flashed prior to cladding installation.

Accessories

Some Scyon™ Axon™ cladding accessories may require installation prior to fixing of the boards. Refer to the relevant details in this document.

FRAMING

General

The Scyon™ Axon™ cladding is installed vertically to both timber and metal studs.

Framing width at sheet joints must be a minimum of 45mm. Where the studs at sheet joints are less than 45mm wide provide double 35mm wide studs at sheet joints. Ensure double studs are well nailed together and flush at the outside face.

All intermediate support studs must be a minimum of 70 x 35mm for timber and 64 x 35mm deep for metal framing. Maximum stud spacings for Scyon™ Axon™ cladding for wind load classifications of AS 4055 'Wind Loads for Housing' are given in Table 1.

NOTE: Brad nailing option is not suitable in high wind areas, see Tables 1 and 2.

TABLE 1

MAXIMUM STUD SPACING - AS 4055			
WIND CLASSIFICATION		STUD SPACING (mm)	
Non-Cyclonic	Cyclonic	General areas	1200mm of building edges
ALL FASTENERS EXCEPT BRAD NAILS			
N1, N2, N3	C1	600	600
N4	C2	600	400
N5, N6	C3/C4	400	300
BRAD NAILS ONLY			
N1, N2, N3	C1	600	600
N4	C2	N/A	N/A
N5, N6	C3, C4	N/A	N/A

Timber

Use of timber framing must be in accordance with AS 1684 - 'Residential timber-framed construction' and the framing manufacturer's specifications.

Use only seasoned timber. Unseasoned timber must not be used because it is prone to shrinkage and can cause sheets and frames to move.

'Timber used for house construction must have the level of durability appropriate for the relevant climate and expected service life and conditions including exposure to insect attacks or to moisture, which could cause decay.' Reference AS 1684.2 'Residential timber-framed construction'.

Steel

Use of steel framing must be in accordance with NASH standard for Residential and Low-Rise Steel Framing Part 1: Design Criteria and the framing manufactures specifications. Framing members must have a base metal thickness (BMT) between 0.55 to 1.6mm. The steel framing must have the appropriate level of durability required to prevent corrosion.

Thermal Break

For steel frames, it's a building code requirement to install a thermal break behind direct fixed cladding. James Hardie recommends the James Hardie™ HardieBreak™ thermal strip. Refer to the HardieBreak™ thermal strip installation guide for more information.

Tolerances

Ensure frame is square and work from a central datum line. Frames must be straight and true to provide a flush face to receive the sheeting. A suggested maximum tolerance of between 3mm and 4mm in any 3000mm length of frame will give best results. Scyon™ Axon™ cladding will not straighten excessively warped or distorted frames and any warping may still be visible after the cladding is applied.



FIGURE 1 FRAME STRAIGHTNESS

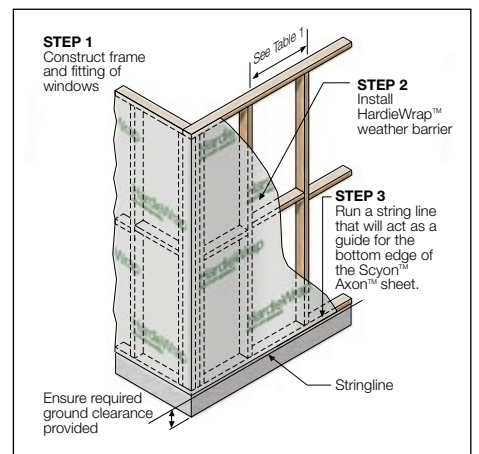

FIGURE 2 PREPARATION

PREPARATION

NOTES

Generally, external and internal corners have additional framing requirements. Refer to the external and internal corner details for more information.

FASTENERS

General

All fasteners specified should be driven flush as shown in Figure 3.

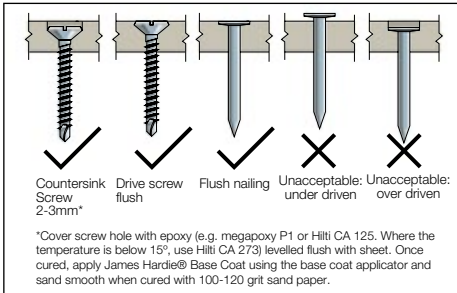

FIGURE 3 NAIL FASTENER DEPTH

Fasteners should be screwed as close as possible to the stud corners to avoid deflection of the stud flange, see Figure 4.

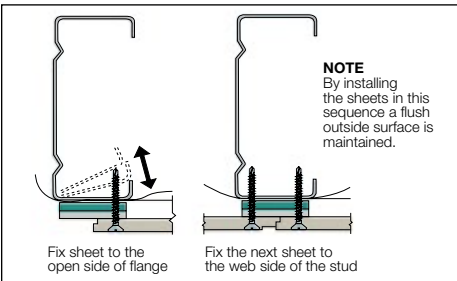

FIGURE 4 SCREW FASTENING

Fastener Durability

Fasteners must have the appropriate level of durability required for the intended project. This is of particular importance in coastal areas, areas subject to salt spray and other corrosive environments. Fasteners must be fully compatible with all other materials that they are in contact with to ensure the durability and integrity of the assembly. Contact fastener manufacturers for more information.

Timber frames

For timber frames, use a ND 50mm 14 gauge 304 stainless steel brad nail. See Table 2 for suitability. Alternatively, a 2.8 x 40mm galvanised fibre cement nail.

NOTE: When using brad nails:

- Do not over drive the fasteners into the sheet.
- Ensure that brad nails are not used in high wind areas, see Tables 1 and 2.
- Where twisting/warping of the top or bottom timber plates may occur, consideration should be given to either using fibre cement nails or closing up brad nail spacings at the plates.

Steel frames

For 0.55mm - 0.75mm BMT steel framing, use 40mm Buildex FibreTEK® screws. For 0.8mm - 1.6mm BMT steel framing, use 40mm HardiDrive® screws. Refer to thermal break statement in Figure 12. Table 2 below outlines the maximum sheet fastener spacings:

TABLE 2

MAXIMUM SHEET FASTENER SPACINGS-AS 4055			
WIND CLASSIFICATION		FASTENER SPACING (mm)	
Non-Cyclonic	Cyclonic	General areas	1200mm of building edges
ALL SPECIFIED FASTENERS EXCEPT BRAD NAILS			
N1, N2, N3	C1	200	200
N4	C2	200	200
N5, N6	C3/C4	200	150
BRAD NAILS ONLY			
N1, N2, N3	C1	150	150
N4	C2	N/A	N/A
N5, N6	C3, C4	N/A	N/A

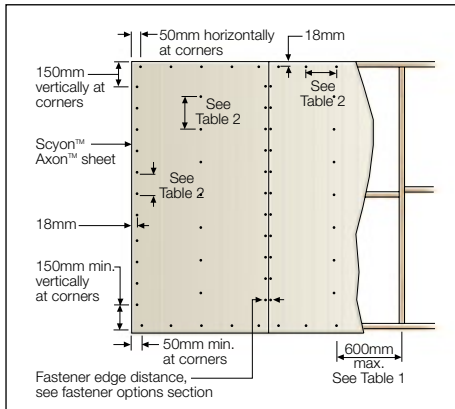

FIGURE 5 SHEET FASTENING SPACING

SHEET INSTALLATION

Note: You must ensure the product is of acceptable quality prior to installation, see Important Note 3.

Scyon™ Axon™ cladding must be installed vertically with all sheet edges fully supported. Sheet joints must coincide with the centre line of the framing member.

At every vertical sheet joint, a 50mm foam back sealing tape is applied under the shiplap vertical joint and in front of the HardieWrap™ Weather Barrier, see Figure 6. Unless its a steel frame and Figure 12 is followed.

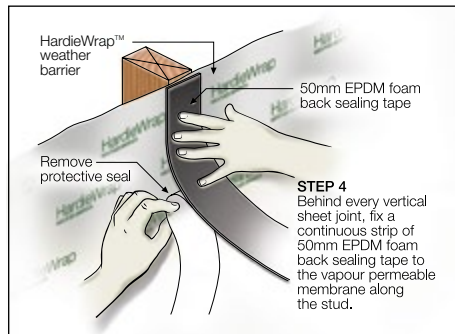

FIGURE 6 APPLY FOAM TAPE

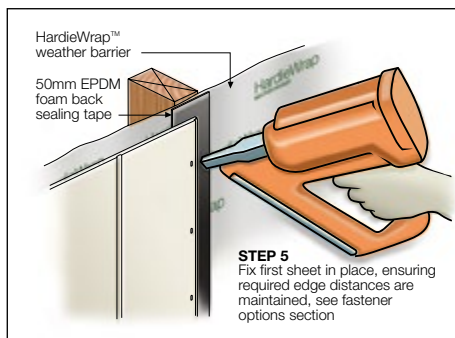

FIGURE 7 FIX FIRST SHEET

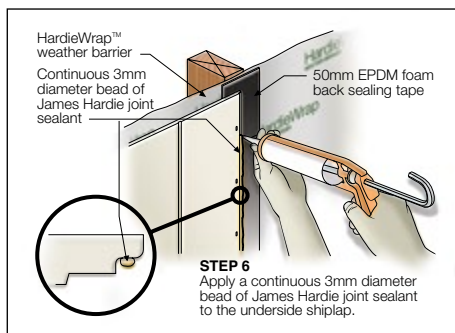

FIGURE 8 APPLY JOINT SEALANT

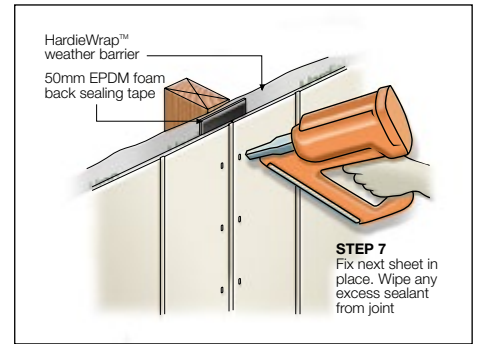

FIGURE 9 FIX NEXT SHEET

FASTENER OPTIONS

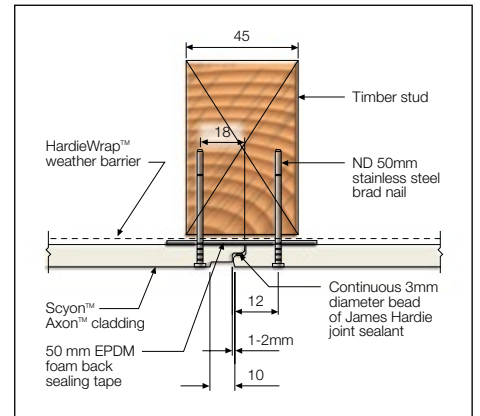

FIGURE 10 BRAD NAIL FIXING

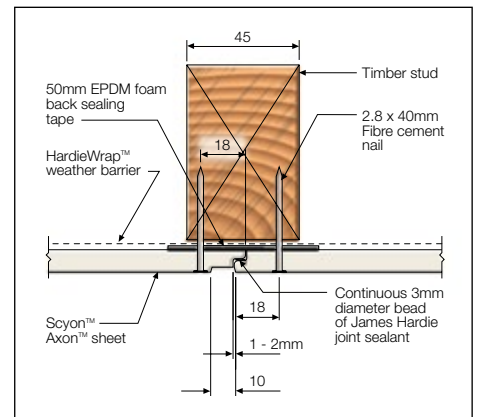

FIGURE 11 FIBRE CEMENT NAIL FIXING

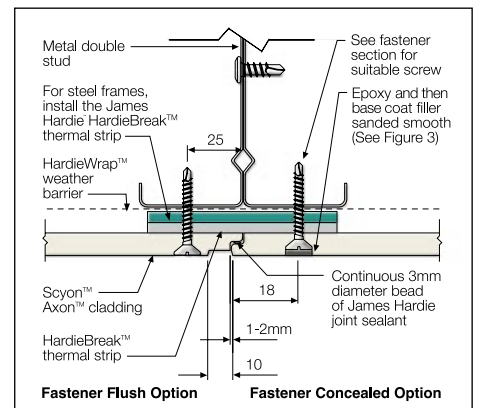

FIGURE 12 SHEET JOINT ON STEEL: FLUSH AND CONCEALED FIXING OPTIONS

CAD's details are available at www.accel.com.au

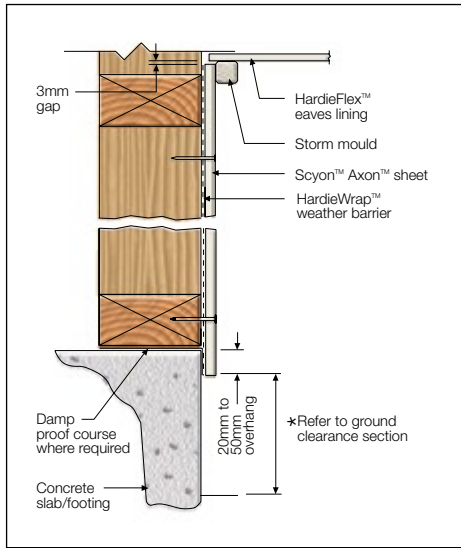

FIGURE 13 SLAB/EAVE JUNCTION DETAIL

WINDOW DETAILS

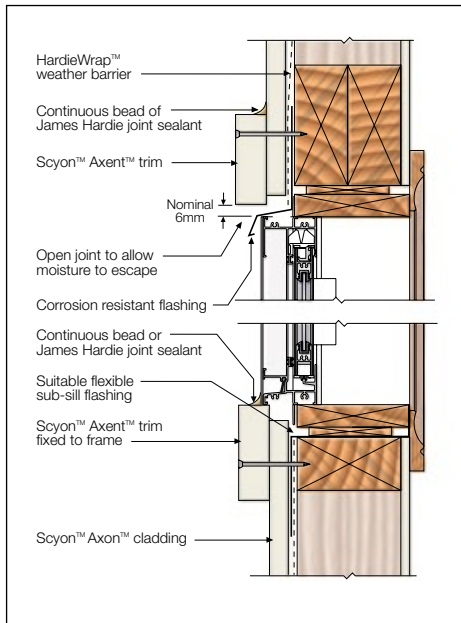

FIGURE 14 WINDOW HEAD AND SILL - TRIM

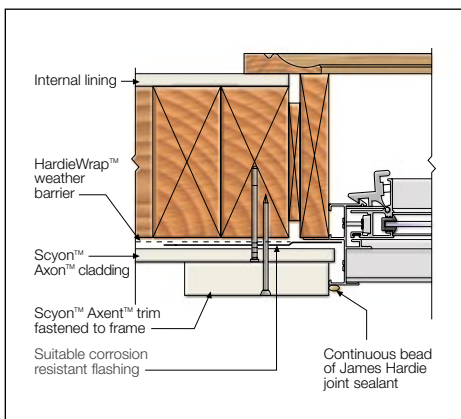

FIGURE 15 WINDOW JAMB - TRIM

EXTERNAL CORNER DETAILS

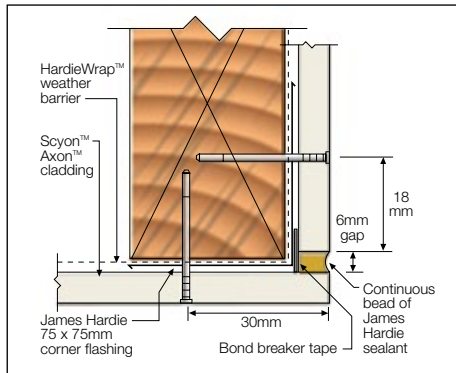

FIGURE 16 SEALANT FILL OPTION

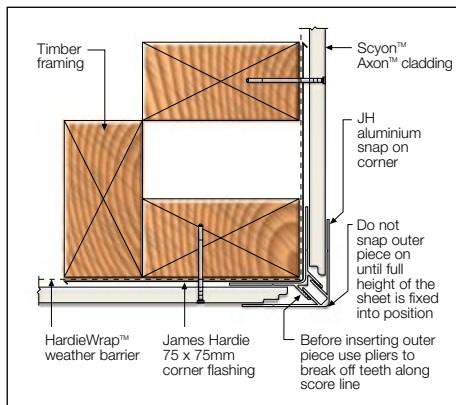

FIGURE 17 SNAP ON CORNER OPTION

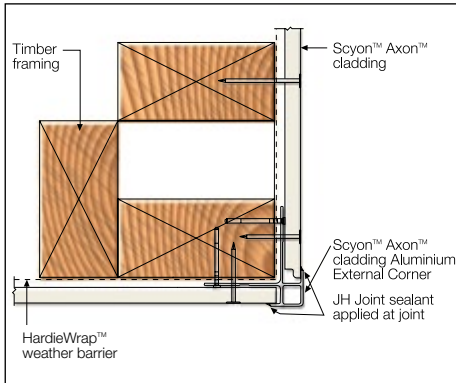

FIGURE 17B ALUMINIUM EXTERNAL CORNER

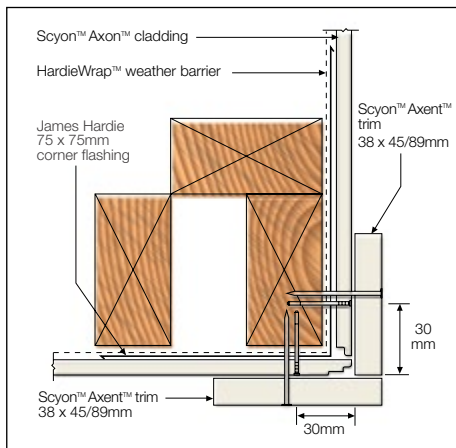

FIGURE 18 TRIM CORNER OPTION

INTERNAL CORNER DETAILS

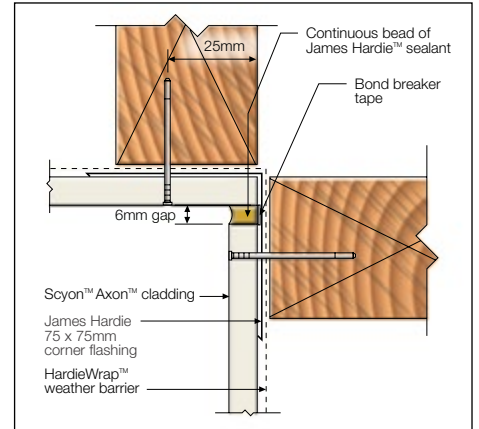

FIGURE 19 SEALANT FILL OPTION

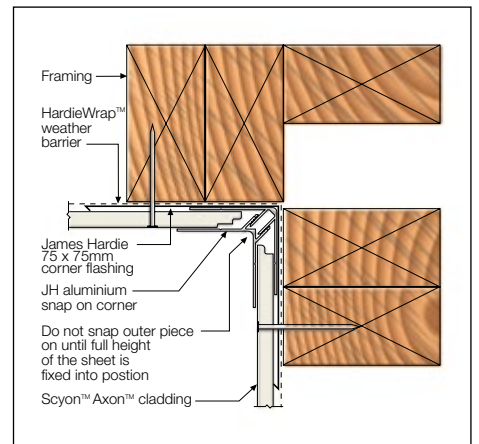

FIGURE 20 SNAP ON CORNER OPTION

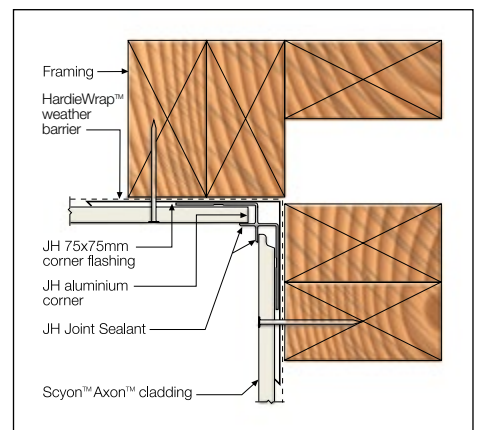

FIGURE 20B ALUMINIUM INTERNAL CORNER

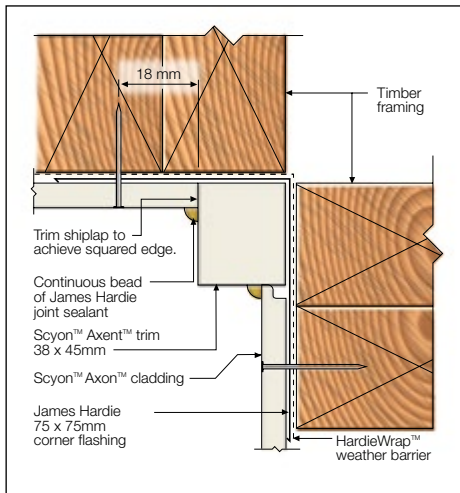

FIGURE 21 TRIM CORNER OPTION

JUNCTION DETAILS

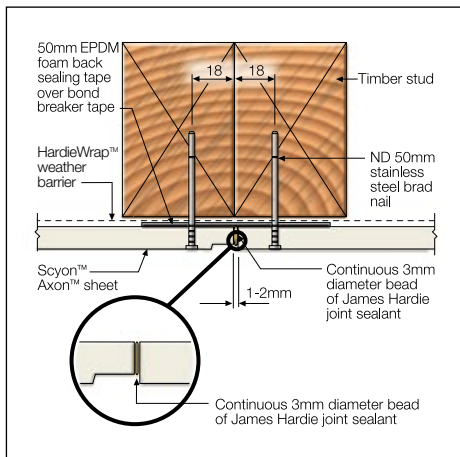

FIGURE 22 VERTICAL BUTT JOINT

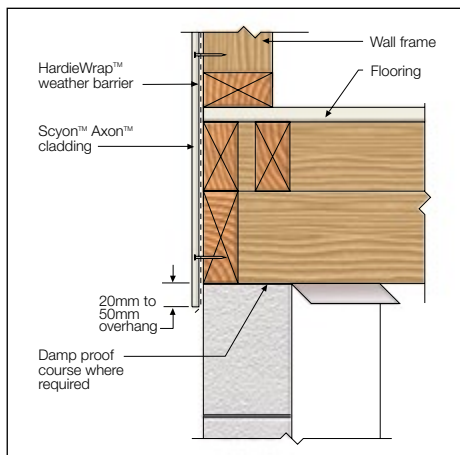

FIGURE 23 LOWER FLOOR JUNCTION

The Scyon™ Axon™ cladding must not continue over a floor junction or where excessive movement or creep will occur, see Figure 24.

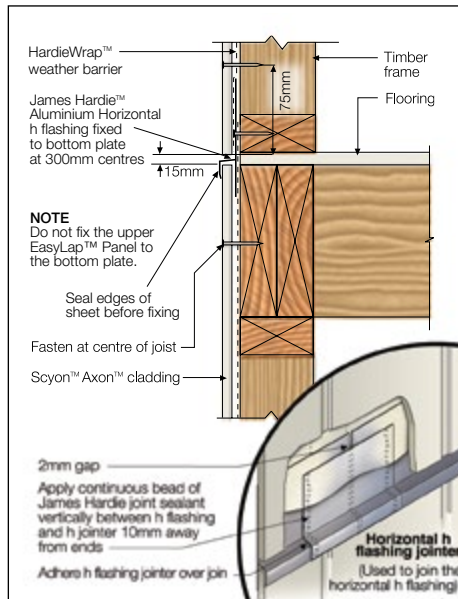

FIGURE 24 UPPER FLOOR JUNCTION/HORIZONTAL JOINT

NOTE: Join the James Hardie 9mm Aluminium Horizontal h flashing on intermediate studs and not off stud or behind sheet joints.

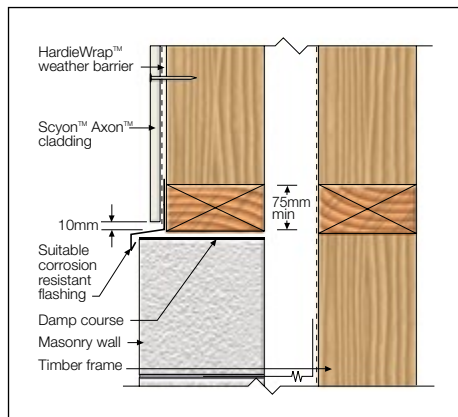

FIGURE 25 HORIZONTAL JUNCTION 1

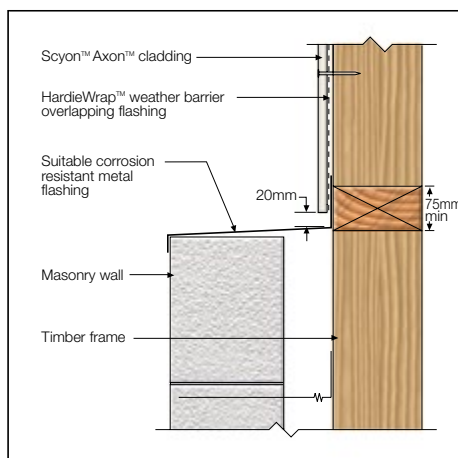

FIGURE 26 HORIZONTAL JUNCTION 2

FINISHING

Sealant

Application and use of sealants must comply with manufacturer's instructions. Sealants, if coated, must be compatible with the paint system. James Hardie recommends the use of James Hardie™ joint sealant, which is a paintable polyurethane sealant.

Painting

Scyon™ Axon™ cladding is primed and ready for painting. All sheets must be dry before painting.

Refer to the project specification for paint requirements. Scyon™ Axon™ cladding must be painted within 3 months of being fixed. In areas within 1km of a coastal area or corrosive environment, the Scyon™ Axon™ cladding must be painted immediately after fixing sheets to minimise contamination build up on the heads of the fasteners, as it may lead to fastener corrosion.

James Hardie recommends the application of two coats minimum of a quality acrylic paint over the pre-primed boards in accordance with the paint manufacturer's specifications. If the screw countersunk option is used, it's recommended that any sanded patches are primed before applying the two final coats. Some environments require special coatings including coastal areas. Painting selection and specifications are dependant on the paint chosen. Refer to the paint manufacturer for further information and details of their warranty.

Staining

James Hardie does not recommend stains and clear coats directly applied to its external cladding products. For a stained look solution, contact the James Hardie technical team on 13 11 03.

MAINTENANCE

The extent and nature of maintenance will depend on the geographical location and exposure of the building. As a guide, it is recommended that basic normal maintenance tasks shall include but not be limited to:

- Washing down exterior surfaces every 6-12 months*
- Periodic inspections should be made to ensure fasteners are adequately securing the sheets to framing.
- Re-applying of exterior protective finishes*
- Maintaining the exterior envelope and connections including joints, penetrations, flashings and sealants that may provide a means of moisture entry beyond the exterior cladding.
- Cleaning out gutters, blocked pipes and overflows as required.
- Pruning back vegetation that is close to or touching the building.

*Refer to your paint manufacturer for washing down and recoating requirements related to paint performance.

PRODUCT INFORMATION

Material

Scyon™ Axon™ cladding is a reengineered concrete formulation utilising patented technology. The basic composition of the Axon cladding is Portland cement, ground sand, cellulose fibre and water. James Hardie building products are manufactured to Australian/New Zealand Standard AS/NZS 2908.2 'Cellulose-cement products-Flat sheet'.

Scyon™ Axon™ cladding is classified Type A, Category 3 in accordance with AS/NZS 2908.2

Durability

Resistance to moisture/rotting

Scyon™ Axon™ cladding has demonstrated resistance to permanent moisture induced deterioration (rotting) by passing the following tests in accordance with AS/NZS 2908.2:

- Water permeability (Clause 8.2.2)
- Warm water (Clause 8.2.4)
- Heat rain (Clause 6.5)
- Soak dry (Clause 8.2.5)

Resistance to termite attack

Based on testing completed by CSIRO Division of Forest Products and Ensis Australia James Hardie building products have demonstrated resistance to termite attack.

Resistance to fire

The Scyon™ Axon™ cladding is suitable where non-combustible materials are required in accordance with C1.12 of the Building Code of Australia. James Hardie building products have been tested by CSIRO in accordance with AS/NZS 3837 and are classified as conforming to Group 1 material (highest and best result possible), with an average specific extinction area far lower than the permissible 250m²/kg, as referenced in Specification C1.10a of the BCA."

Alpine regions

In regions subject to freeze/thaw conditions, all James Hardie fibre cement external cladding must be installed and painted in the warmer months of the year where the temperature does not create freeze and thaw conditions or paint issues. The cladding must be painted immediately after installation. In addition, fibre cement cladding must not be in direct contact with snow and/or ice build up for extended periods, e.g. external walls in alpine regions subject to snow drifts over winter.

Furthermore, a reputable paint manufacturer must be consulted in regards to a suitable product, specifications and warranty. The paint application must not be carried out if the air temperature or the substrate temperature is outside the paint manufacturer's recommendation including the specified drying temperature range.

James Hardie external cladding products are tested for resistance to frost in accordance with AS/NZS 2908.2 Clause 8.2.3.

Scyon™ Axon™ cladding

10 Year Warranty

January 2012

James Hardie Australia Pty Limited ("James Hardie") warrants to the first purchaser of Scyon™ Axon™ cladding (**Product**) from James Hardie and the last purchaser of the Product prior to installation that, subject to compliance with the Conditions of Warranty below:

- for a period of 10 years from the date of purchase, the Product will be free from defects due to defective factory workmanship or materials; and
- for a period of 10 years from the date of purchase, the Product will be resistant to damage from cracking, moisture, rotting, fire and termites to the extent set out in James Hardie's relevant published literature current at the time of installation; and
- for a period of 12 months from the date of purchase that the accessories supplied by James Hardie will be free from defects due to defective factory workmanship or materials.

For the purposes of this warranty, a "defect" in respect of the Product means a non-compliance with AS/NZS 2908.2:2000 Cellulose-cement products - Flat sheet.

CONDITIONS OF WARRANTY

This warranty is strictly subject to the following conditions:

- (a) James Hardie will not be liable for breach of this warranty unless the claimant provides proof of purchase of the Product and makes a written claim to James Hardie at the address set out below, either within 30 days after the defect would have become reasonably apparent or, if the defect was reasonably apparent prior to installation, then the claim must be made prior to installation.
- (b) the Product is subject to natural variation in finish as part of the manufacturing process. The builder/installer must ensure the Product meets aesthetic requirements before installation. Subject to the terms of this warranty, after installation of the Product, James Hardie is not liable for claims arising from aesthetic surface variations if such variations were, or would upon reasonable inspection have been, apparent prior to installation;
- (c) this warranty cannot be relied upon by any other person and is not transferable;
- (d) the Product must be installed and maintained strictly in accordance with the relevant James Hardie literature current at the time of installation and must be installed in conjunction with the components or products specified in the literature. To obtain copies of such literature go to or contact Ask James Hardie™ on 13 11 03. Further, all other products, including coating and jointing systems, applied to or used in conjunction with the Product must be applied or installed and maintained strictly in accordance with the relevant manufacturer's instructions and good trade practice;
- (e) the project must be designed and constructed in strict compliance with all relevant provisions of the current Building Code of Australia, regulations and standards;
- (f) if the claimant chooses to rely upon this warranty then the claimant's sole remedy under this warranty for breach of this warranty is (at James Hardie's option) that James Hardie will either supply replacement Product, rectify the affected Product or pay for the cost of the replacement or rectification of the affected Product;

- (g) In the circumstances where the Australian Consumer Law does not apply in respect of the purchase of the Product, James Hardie will not be liable for any losses or damages (whether direct or indirect) including property damage or personal injury, consequential loss, economic loss or loss of profits, arising in contract or negligence or howsoever arising. Without limiting the foregoing, James Hardie will not be liable for any claims, damages or defects arising from or in any way attributable to poor workmanship, poor design or detailing, settlement or structural movement and/or movement of materials to which the Product is attached, incorrect design of the structure, acts of God including but not limited to earthquakes, cyclones, floods or other severe weather conditions or unusual climatic conditions, efflorescence or performance of paint/coatings applied to the Product, normal wear and tear, growth of mould, mildew, fungi, bacteria, or any organism on any Product surface or Product (whether on the exposed or unexposed surfaces);
- (h) In the circumstances where the Australian Consumer Law does not apply in respect of the purchase of the Product, all warranties, conditions, liabilities and obligations other than those specified in this warranty are excluded to the fullest extent allowed by law;
- (i) If meeting a claim under this warranty involves re-coating of Product, there may be slight colour differences between the original and replacement Product due to the effects of weathering and variations in materials over time and James Hardie is not liable for any such colour differences;
- (j) In the circumstances where the Australian Consumer Law does not apply in respect of the purchase of the Product and therefore to this warranty, all expenses incurred as a result of claiming under this warranty are to be borne by the claimant.
- (k) In the circumstances where the Australian Consumer Law does apply in respect of the purchase of the Product and therefore to this warranty, if James Hardie accepts or it is determined by James Hardie that the claimant has a valid claim under this warranty, James Hardie will bear the claimant's reasonable costs of claiming under this warranty. The claimant is responsible for all other costs of claiming under this warranty. All claims for such costs are to be notified to James Hardie at the address outlined below within 21 days from when the claimant first makes a claim under this warranty.

DISCLAIMER

The recommendations in James Hardie's literature are based on good building practice but are not an exhaustive statement of all relevant information and are subject to conditions (d), (e), (g) and (h) above. Further, as the successful performance of the relevant system depends on numerous factors outside the control of James Hardie (e.g. quality of workmanship and design), James Hardie shall not be liable for the recommendations in that literature and the performance of the relevant system, including its suitability for any purpose or ability to satisfy the relevant provisions of the Building Code of Australia, regulations and standards.

IMPORTANT NOTE

If you acquire goods manufactured by James Hardie as a consumer according to the Australian Consumer Law, our goods come with guarantees that cannot be excluded under the Australian Consumer Law. You are entitled to a replacement or refund for a major failure and compensation for any other reasonably foreseeable loss or damage. You are also entitled to have the goods repaired or replaced if the goods fail to be of acceptable quality and the failure does not amount to a major failure.

Any rights a consumer may have under this warranty are in addition to other rights and remedies of a consumer under a law in relation to the goods to which this warranty relates. Nothing in this document shall exclude or modify any legal rights a customer may have under the Australian Consumer Law or otherwise which cannot be excluded or modified at law.

Contact details if you wish to make a claim under this warranty: For more information or to make a claim under this warranty please Ask James Hardie™ on 13 11 03, visit www.jameshardie.com.au or www.accel.com.au, email James Hardie via our website or write to James Hardie at:

James Hardie Australia Pty Ltd
10 Colquhoun Street Rosehill NSW 2142
PO Box 70 Parramatta NSW 2124

© Copyright 2012 James Hardie Australia Pty Ltd. ABN 12 084 635 558. ™ and ® denotes a trademark or registered mark owned by James Hardie Technology Limited

Ask James Hardie™
Call 13 11 03
www.jameshardie.com.au