



we  clean

User Guide

Vax Careline: AU: 1300 361 505
NZ: 0800 800 900

Steam Cleaner

steam

home master

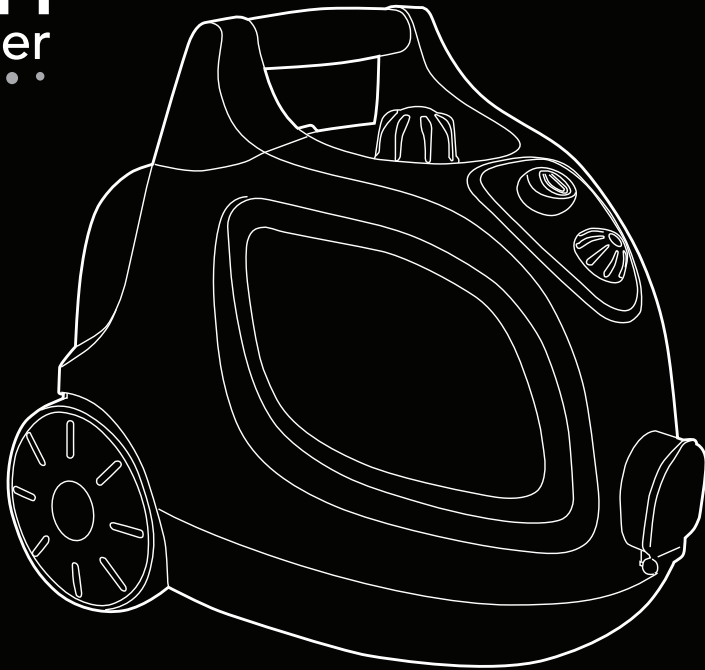

Get Cleaning...

What's your Vax's model number?

V S T H M 1 6 0 0

What's your serial number? (Located on the base of the machine)

Note these down in case you need them in future. Please keep instructions for further use.

Vax Service line

AU: 1300 361 505 / NZ: 0800 800 900

Machine Overview

- 1 Carry handle
- 2 Water tank lid
- 3 On/off button
- 4 Steam ready (green LED)
- 5 Water heating (red LED)
- 6 Variable steam dial
- 7 Hose outlet
- 8 Tool storage

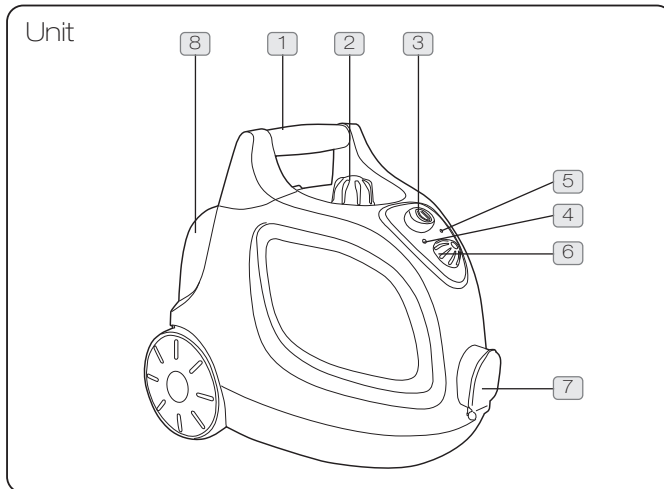

- 9 Steam handle and hose
 - a) Extension tube release
 - b) Safety latch
 - c) Steam trigger

- 10 Metal brush
- 11 Detail nozzle
- 12 Small plastic brush
- 13 Large plastic brush
- 14 Scraper tool
- 15 Concentration nozzle
- 16 Window/upholstery tool
- 17 Floor head
- 18 Floor head connector
- 19 Measuring jug
- 20 Funnel
- 21 3pc extension tubes
- 22 Upholstery cloth (x2)
- 23 Floor head cloth (x2)

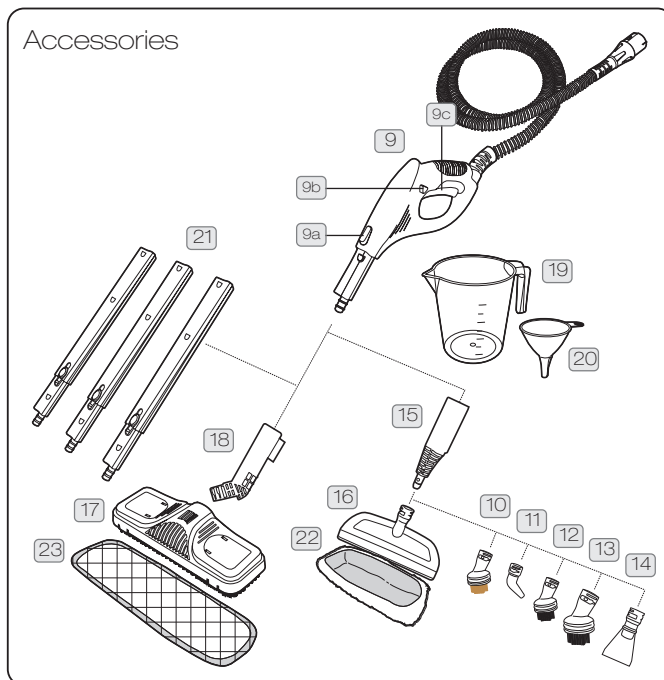

General Safety Information

FOR HOUSE HOLD USE ONLY.







When using the steam cleaner, basic safety precautions should always be observed, including the following:



WARNING: The steam cleaner unit and accessories get very hot during operation.



DANGER OF SCALDING: Avoid contact with the steam.

1. Do not leave the steam cleaner unattended when plugged in. The steam cleaner has to be unplugged after use and before carrying out user maintenance on the steam cleaner.
2. Children should be supervised to ensure that they do not play with the appliance.
3. This appliance is not intended for use by persons (including children) with reduced physical, sensory or mental capabilities, or lack of experience and knowledge, unless they have been given supervision or instruction concerning use of the appliance by a person responsible for their safety.
4. Use only as described in this manual. Use only Vax recommended attachments.
5. Do not use the steam cleaner if it has been dropped, damaged, left outdoors or dropped into water. Do not use the steam cleaner with a damaged cord or plug. If the supply cord is damaged, it must be replaced by the manufacturer or a recommended Service Agent to avoid hazard.
6. Do not pull or carry by the cord, use the cord as a handle, allow the cord to come into contact with hot or sharp surfaces or close a door on the cord. Keep cord away from heated surfaces.
7. Do not handle the plug or steam cleaner with wet hands.
8. Do not put any objects into openings or operate with openings blocked.
9. Do not use the steam cleaner with an extension cord.
10. Do not attempt to remove blockages with sharp objects as they may cause damage.
11. Store indoors, put away after use to prevent tripping accidents.
12. The steam cleaner must be kept level during operation.
13. Never immerse the steam cleaner in water or other liquids. Keep the steam cleaner away from rain and moisture. The steam cleaner is not suitable for outdoor use.
14. Do not operate the steam cleaner without water in the tank. Always top up with water in good time and only when steam cleaner is switched off and unplugged at the mains.
15. Never fill the tank with anything other than water. Never put additives (such as perfume, stain remover or products containing alcohol) in the water as they may damage the steam cleaner or make it dangerous to use.
16. Always remove the mains plug from the socket and allow this steam cleaner to cool down completely before topping up with water.
17. Do not over fill the tank. Do not exceed the maximum prescribed filling level. Please use the measuring jug included.
18. Ensure that the water tank cap has been screwed down fully before use. Do not use without the tank cap in place.
19. Only carry the steam cleaner by the carry handle.
20. Do not touch any hot areas on the steam cleaner. It is normal for the steam cleaner to heat up during operation.
21. Do not use the steam cleaner to treat any items of clothing that are still being worn on the body.
22. The force and heat of the steam may have an adverse effect on some materials. Always check whether a surface is suitable for treatment with the steam cleaner by carrying out a test beforehand on a concealed area.
23. Never aim the steam cleaner at people, animals or plants (risk of scalding)! The liquid or steam must not be directed towards equipment containing electrical components, such as the interior of ovens.
24. The steam cleaner is fitted with a thermostat and a thermal cut-out as protection against overheating.
25. Accessories become hot during use - allow them to cool down before handling.
26. Please ensure all parts are correctly fitted before using the product.
27. Symbol IEC 60417-5597 (2002-10)  is used as the unit to indicate the following:
 -  **WARNING:** Danger of Scalding.
 -  **WARNING:** Never leave the steam mop head when in use on flooring, in one spot on any surface for an extended period of time as this may damage the floor surface.
 -  **IMPORTANT:** This steam cleaner may not be suitable for all types of floorboards - please check with your floorboard manufacturer first prior to use.
 -  **NOTE:** The liquid or steam must not be directed towards equipment containing electrical components, such as the interior of ovens.
 -  **IMPORTANT:** Vax recommends the use of a Residual Current Device with a Residual Current Rating of 30mA or less.
 -  **WARNING:** Always switch off and unplug the steam cleaner from the electrical outlet before assembling, opening or emptying the water tank.

This machine is intended for house hold use only, and NOT for commercial or industrial use.

PLEASE KEEP THESE INSTRUCTIONS FOR FURTHER USE.

Operation

Operating your steam cleaner

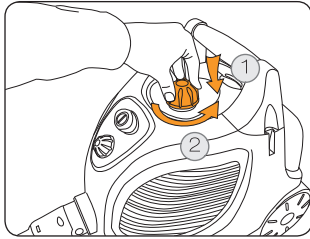

To remove lid push down and twist anti-clockwise.

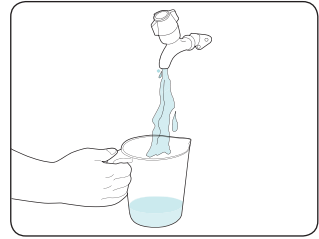
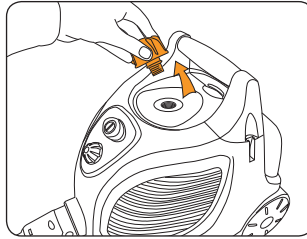

Fill measuring jug to the max mark.

NOTE: Maximum jug capacity is 700ml

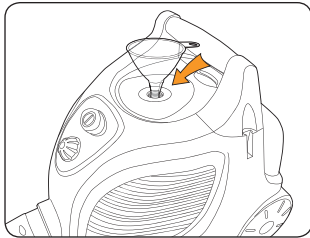

Insert the funnel into the water tank to make filling the tank easier.

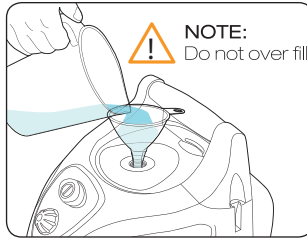

Slowly pour liquid into water tank.

NOTE: Maximum tank capacity is 1.6L (2.2 jugs)

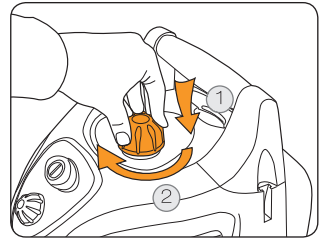

Ensure lid is securely fastened by pushing down and twisting clockwise.

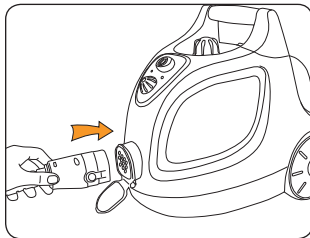

Attach hose to unit.

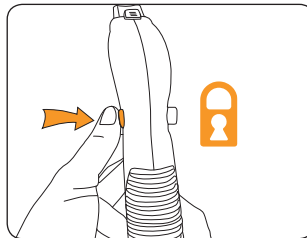

Ensure steam handle safety latch is on before heating.

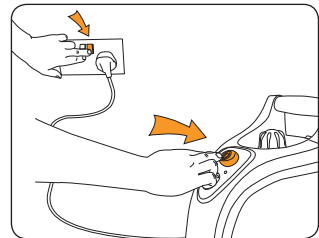

Turn steam cleaner on.

Operation

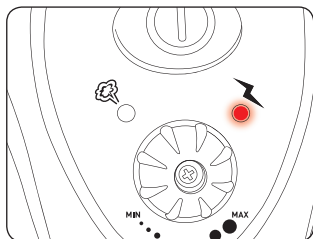

Red light will illuminate when unit is heating.

NOTE: Steam heats up in approx. 12 minutes.

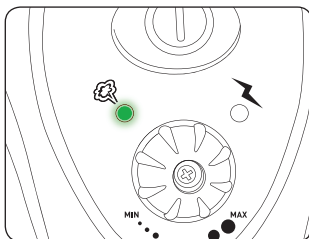

Green light will illuminate when unit is ready to use.

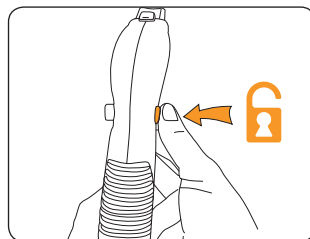

Release steam handle safety latch.

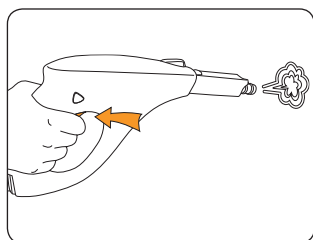

Press steam trigger to release steam.

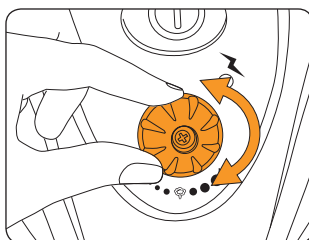

Rotate variable steam dial to adjust pressure.

NOTE: Steam run per full tank is approx. 40 minutes.

Accessories – Extension tubes

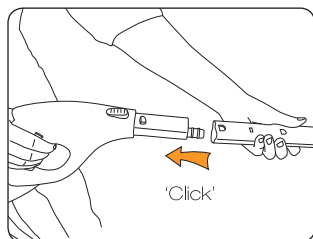

Attach extension tube to handle.

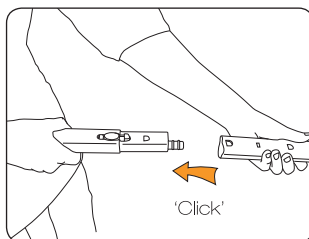

Attach extension tubes together.

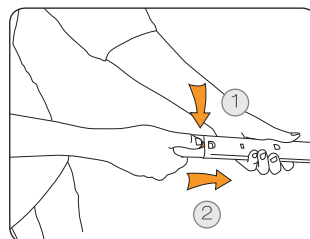

To remove/release tubes, press latch as shown.

Operation

Floor head

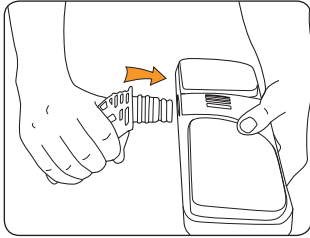

Attach the floor head connector to the floor head.

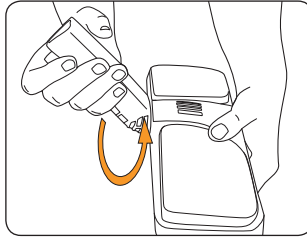

Rotate floor head connector into place.

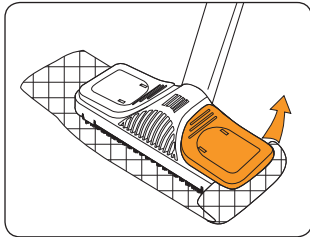
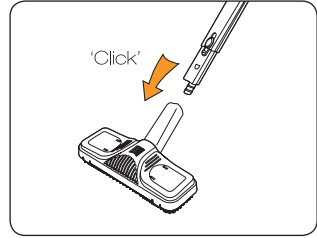

Lift levers on either side of the floor head to secure floor cloth.

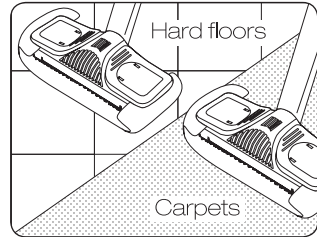
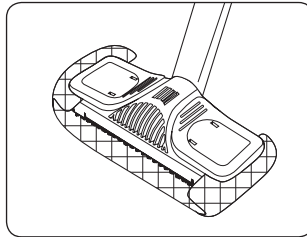

Attaching small tools

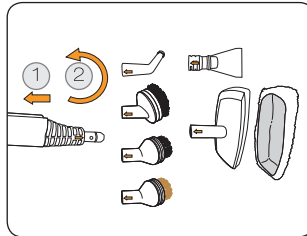
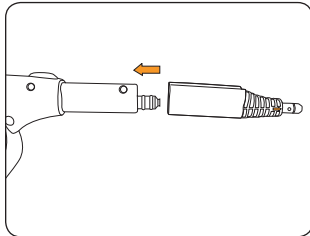

1. Push small tools onto concentration nozzle aligning arrows.

2. Twist clockwise to fit.



NOTE: Concentration nozzle must be attached before fitting the small tools.

Operation

Accessories - Using the small tools

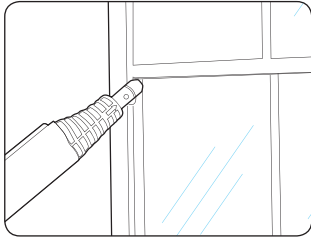

Concentration nozzle

Use to remove soap scum in baths and shower enclosures and to clean heavily soiled areas in kitchens.

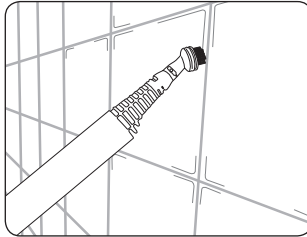

Brushes

Agitate stubborn grease and grime.



Metal brush

For oven grills and racks.



Window tool

Great for leaving your windows and mirrors gleaming and smear-free.

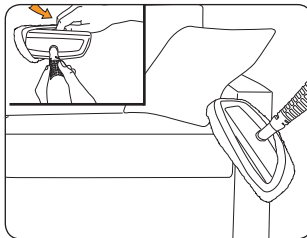

Upholstery tool

Attach the upholstery tool cloth to the window tool for use on sofa and chair fabrics.

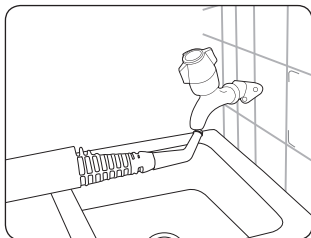

Detail tool

For hard to reach areas e.g. around taps.

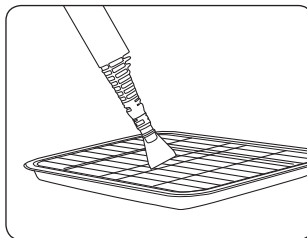

Scraper tool

Can be used to defrost freezers.

IMPORTANT: Test a hidden area before use. Do not use on non-stick surfaces.

IMPORTANT: Test for colour fastness in a small hidden area of upholstery to check for colour removal before use.

Maintenance (Keep your Vax as good as new)

Cleaning cloths

Cloths can either be washed by hand or machine washed at 30° C with mild detergent.

Storage



IMPORTANT: Please ensure the steam cleaner has completely cooled down before storing.



IMPORTANT: When storing your machine, turn the unit off at the plug and hold steam trigger down to release remaining steam pressure.

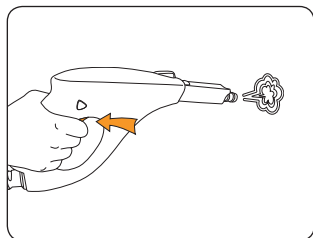

Press steam trigger to release steam.

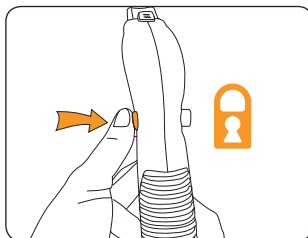

Ensure steam handle safety latch is on.

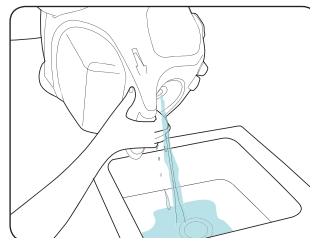

Empty unit of any remaining water.

FAQ's



WARNING: To reduce the risk of personal injury, unplug the hard floor cleaner before performing maintenance/troubleshooting checks.

Problem	Solution
Is there an accessory missing?	Check the parts overview page in this guide to make sure the part is definitely included with your machine.
	If the part is missing, we're here to help. Simply call us on: Aus 1300 361 505 or NZ 0800 800 900
What do I do if the machine/an accessory has become damaged or broken?	Visit vax.com.au for spares and parts.
	Please call our Careline to purchase new spares or order a replacement.
Why won't the steam cleaner run?	The unit may not be plugged into an electrical outlet; ensure the plug is pushed in securely.
	Check the mains power is switched on.
	The electrical outlet may not be working; check the fuse or breaker and consult an electrician.
	The power cord may be damaged; if it is it must be replaced by the manufacturer.
Why is the steam cleaner not producing steam?	Ensure that the mains power is switched on and the power button has been pressed on the unit.
	There may be no water in the tank; please refer to the operation section.
	Check that the safety latch has been unlocked on the steam handle.
	The water may not yet be at temperature; the green steam ready indicator light will illuminate when the water is at temperature and is ready to use.
	If the unit is producing a very small amount of steam, check the variable steam dial and adjust to max.
	If none of the points above are of assistance, we're here to help. Simply call us on: Aus 1300 361 505 or NZ 0800 800 900
What do I do if the steam cleaner takes a long time to heat up?	If you live in a hard water area the water tank may have become blocked by limescale - The unit will then need to be descaled.
	Otherwise, we're here to help. Simply call us on: Aus 1300 361 505 or NZ 0800 800 900



we  to help

Don't take me back to the shop, simply call us

AU: 1300 361 505
NZ: 0800 800 900 www.vax.com.au

This does not affect your statutory rights

Other Information

Vax Service & Help

Vax Careline:

Australia 1300 361 505

New Zealand 0800 800 900

Monday-Friday 8.30am to 5.00pm

If you have queries or concerns about using your Vax, call the Vax Careline. Calls are charged at the standard local rate. Please make a note of the serial number and model number of the vacuum cleaner before calling.

For the nearest Service Agent, please call the Vax Customer Careline or visit www.vax.com.au

Technical Specification

Voltage: 220-240V ~50Hz

Wattage: 1400 – 1600W

Water tank capacity: 1.6L

Cord length: 6m

Weight: 4.7kg

Subject to technical change without notice.



N197



Indoor
Use



Read
Instructions

EEC Statement of Compliance

Manufacturer/EEC importer: Vax Limited, hereby on our own responsibility, declare that the S6 steam cleaner series is manufactured in compliance with the following Directives:

Safety: 2006/95/EC Low Voltage Directive

EMC: 2004/108/EC Electromagnetic Compatibility Directive



Waste electrical products should not be disposed of with household waste. Please recycle where facilities exist. Check with your Local Authority or retailer for recycling advice.



we  clean

Distributed by Techtronic Industries Pty. Ltd.
Level 1, 660 Doncaster Road, Doncaster, Australia 3108.
www.vax.com.au Service Line: AU: 1300 361 505 / NZ: 0800 800 900