

**IMPORTANT NOTES**

1. Failure to install, finish or maintain this product in accordance with applicable building codes, regulations, standards and James Hardie's written application instructions may lead to personal injury, affect system performance, violate local building codes, and void James Hardie's product warranty.
2. All warranties, conditions, liabilities (direct, indirect or consequential) and obligations whether arising in contract, tort or otherwise other than those specified in James Hardie's product warranty are excluded to the fullest extent allowed by law. For James Hardie's product warranty information and disclaimers about the information in this manual, see the section at the end of this manual
3. The builder must ensure the product meets aesthetic requirements before installation. James Hardie will not be responsible for rectifying aesthetic surface variations following installation.
4. Make sure your information is up to date. When specifying or installing James Hardie® products, ensure you have the current manual. If in doubt, or you need more information, visit [www.jameshardie.com.au](http://www.jameshardie.com.au), [www.scyon.com.au](http://www.scyon.com.au) or Ask James Hardie™ on 13 11 03.

**SCYON™ LINEA™ WEATHERBOARD AND SCYON™ AXENT™ TRIM SIZES**











Product	Length (mm)	Width (mm)	Thickness (mm)	End details	COVERAGE INFORMATION				
					Effective cover (mm)	No. of planks/ metre height	Mass kg/lin m	Mass kg/m²	Pallet weight (90/pack) kg
150mm Scyon™ Linea™ weatherboard	4200*	150	16	T & G	120	8.3	2.8	23.2	1350
180mm Scyon™ Linea™ weatherboard	4200*	180	16	T & G	150	6.7	3.4	22.7	1620

Scyon™ Axent™ trim - Refer to current Scyon™ Axent™ trim manual for sizes.





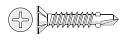





**NOTES**

1. All dimensions and masses provided are approximate only and subject to manufacturing tolerances. Masses are based on equilibrium moisture content of product.
2. \*Length is 4200mm plus 5mm for the tongue and groove (T & G) making the length 4205mm overall.
3. Refer to page 3 for details of the effective cover and lapped thickness of the cladding.

**ACCESSORIES / TOOLS SUPPLIED BY JAMES HARDIE**

ACCESSORIES	DESCRIPTION	ACCESSORIES	DESCRIPTION
	<b>Linea™ PVC starter strip 3,000mm long</b> A perforated PVC starter strip used to set out the bottom edge of Scyon™ Linea™ weatherboards at the correct angle. 25 per pack. Part No. 305571		<b>James Hardie™ Aluminium Internal corner mould 3600mm long 5pk</b> A ready to paint aluminium extrusion to be used with Scyon™ Linea™ weatherboard to create internal corners. 5 per pack. Part No. 305511
	<b>Linea™ Aluminium Corner Soaker for 150mm wide boards</b> A ready to paint aluminium external corner soaker for use with 150mm wide Scyon™ Linea™ weatherboards. 100 per box. Part No. 305574		<b>Linea™ Aluminium Universal Window Adaptor, 3,700mm long</b> A ready to paint aluminium extrusion to be used adjacent to windows to finish the edge of Scyon™ Linea™ weatherboard. 5 per pack. Part No. 305510
	<b>Linea™ Aluminium Corner Soaker for 180mm wide boards</b> A ready to paint aluminium external corner soaker for use with 180mm wide Scyon™ Linea™ weatherboards. 100 per box. Part No. 305572		<b>James Hardie™ Joint Sealant. 300ml cartridge</b> A general purpose, paintable, exterior grade polyurethane joint sealant. 20 per box. Part No. 305534
	<b>Linea™ Aluminium External Slimline Boxed Corner, 3,600mm long</b> A ready to paint aluminium extrusion to be used with Scyon™ Linea™ weatherboard to create external boxed corners. 40x40mm caps are available to seal the bottom. A 6mm hole must be drilled to release trapped water (supplied by others). 5 per pack. Part No. 305512		<b>HardieBlade™ Saw Blade. 185mm diameter</b> A 185mm diameter poly-diamond blade for fast and clean cutting of James Hardie fibre cement. 1 each. Part No. 300660
	<b>Linea™ PVC Box Corner Z Flashing. 2,700mm long</b> A PVC Z flashing for use with Scyon™ Linea™ weatherboard in conjunction with Scyon™ Axent™ trim to form external corners. 25 per pack. Part No. 305570		<b>HardieDrive™ Screw 40mm long</b> A class 3 finish self-tapping wing-tipped screw for fastening to 0.8mm to 1.6mm BMT steel frames. 500 per box. Part No. 305532
	<b>James Hardie™ 75x75mm Colorbond® Corner Flashing. 3,000mm long</b> A Colorbond® corner flashing for use behind cladding at internal and external corners. 5 per pack. Part No. 305564		<b>HardieWrap™ weather barrier</b> A non-perforated, highly breathable and reflective safe-glare weather barrier designed to be used behind Scyon™ external cladding products to help protect the building. For alternate products, please refer to HardieWrap™ weather barrier section (p.2) Unit size 2750mm x 3000mm Part No. 305664.

**COMPONENTS NOT SUPPLIED BY JAMES HARDIE** James Hardie recommends the following products for use in conjunction with its Scyon™ Linea™ weatherboard and Scyon™ Axent™ trim. James Hardie does not supply these products and does not provide a warranty for their use. Please contact component the manufacturer for information on their warranties and further information on their products.

	<b>40 x 2.8mm fibre cement nails</b> For concealed fixing Scyon™ Linea™ weatherboard and various accessories to timber framing as specified.		<b>52mm special wing screw by TRI-FIX</b> For face fixing to 0.55 - 1.2mm BMT steel framing. Available in galvanised and stainless steel.
	<b>60 x 3.15mm bullet head nails</b> For face fixing Scyon™ Linea™ weatherboard to timber framing as specified.		<b>3.0mm dia drill bit</b> For pre-drilling where required.
	<b>Bullet head nails Screws</b> 50 or 65mm x 2.8mm diameter corrosion resistant bullet head nails. Nail holes must be pre drilled.		<b>Gun nails and nailers</b> Suitable gun nails and nailers for concealed fixing to timber framing. Minimum nail length of 40mm is required.
	<b>40mm Buildex FibreTEKS®</b> Galvanised screw for concealed fixing to 0.55 - 0.75mm BMT steel framing.		<b>Vacuum extraction with HEPA filter</b> Used with HEPA filter and paper bag for reduced dust exposure
	<b>40mm special wing screw by TRI-FIX</b> For concealed fixing to 0.55 - 1.2mm BMT steel framing. Available in galvanised and stainless steel.		<b>Compound mitre saw</b> Dust reducing compound mitre saw used with HardieBlade™ saw blade. Makita: LS0714/LS1013/LS1212 Hitachi: C10FSB/C12FSB

**WARNING**
**DO NOT BREATHE DUST AND CUT ONLY IN WELL VENTILATED AREA**

James Hardie products contain sand, a source of respirable crystalline silica which is considered by some international authorities to be a cause of cancer from some occupational sources. Breathing excessive amounts of respirable silica dust can also cause a disabling and potentially fatal lung disease called silicosis, and has been linked with other diseases. Some studies suggest smoking may increase these risks. During installation or handling:

- (1) work in outdoor areas with ample ventilation;
- (2) minimise dust when cutting by using either 'score and snap' knife, fibre cement shears or, where not feasible, use a HardieBlade™ saw blade and dust reducing circular saw attached to a HEPA vacuum;
- (3) warn others in the immediate area to avoid breathing dust;
- (4) wear a properly-fitted, approved dust mask or respirator (e.g. P1 or P2) in accordance with applicable government regulations and manufacturer instructions to further limit respirable silica exposures. During clean-up, use HEPA vacuums or wet cleanup methods - never dry sweep. For further information, refer to our installation instructions and Material Safety Data Sheets available at [www.jameshardie.com.au](http://www.jameshardie.com.au). FAILURE TO ADHERE TO OUR WARNINGS, MATERIAL SAFETY DATA SHEETS, AND INSTALLATION INSTRUCTIONS MAY LEAD TO SERIOUS PERSONAL INJURY OR DEATH.

**JAMES HARDIE RECOMMENDED SAFE WORKING PRACTICES**
**CUTTING OUTDOORS**

1. Position cutting station so wind will blow dust away from the user or others in working area.
2. Use a dust reducing circular saw equipped with HardieBlade™ saw blade and HEPA vacuum extraction.

**DRILLING/OTHER MACHINING**

When drilling or machining you should always wear a P1 or P2 dust mask and warn others in the immediate area.

**IMPORTANT NOTES**

1. NEVER use a power saw indoors.
2. NEVER use a circular saw blade that does not carry the HardieBlade™ logo.
3. NEVER dry sweep - Use wet suppression or HEPA vacuum.
4. NEVER use grinders.
5. ALWAYS follow tool manufacturers' safety recommendations.

P1 or P2 respirators should be used in conjunction with above cutting practices to further reduce dust exposures. Additional exposure information is available at [www.jameshardie.com.au](http://www.jameshardie.com.au) to help you determine the most appropriate cutting method for your job requirements. If concern still exists about exposure levels or you do not comply with the above practices, you should always consult a qualified industrial hygienist or contact James Hardie for further information.

**STORAGE AND HANDLING**

To avoid damage, all James Hardie building products should be stored with edges and corners of the product protected from chipping. James Hardie building products must be installed in a dry state and protected from weather during transport and storage. The product must be laid flat under cover on a smooth level surface clear of the ground to avoid exposure to water, moisture, etc.

## DESIGN

### Compliance

All design and construction must comply with the appropriate requirements of the current Building Code of Australia (BCA), regulations and standards.

### Responsibility

The specifier or other party responsible for the project must ensure that the details in this specification are appropriate for the intended application and that additional detailing is performed for specific design of any areas that fall outside the scope of this specification.

### Slab and footings

The slab and footings on which the building is situated must comply with AS 2870 'Residential slabs and footings – Construction' and the requirements of the Building Code of Australia (BCA).

### Ground clearances

Install James Hardie external cladding with a minimum 150mm clearance to the earth on the exterior of the building or in accordance with local building codes if greater than 150mm is required. Maintain a minimum 50mm clearance between James Hardie external cladding and roofs, decks, paths, steps and driveways.

Adjacent finished grade must slope away from the building in accordance with local building codes, typically a minimum slope of 50mm minimum over the first metre. Do not install external cladding such that it may remain in contact with standing water.

### NOTE

Greater clearance may be required in order to comply with termite protection provisions, see below.

### Termite protection

The BCA specifies the requirements for termite barriers and must be complied with. Where the exposed slab edge is used as part of the termite barrier system, a minimum of 75mm of the exposed slab edge must be visible to permit ready detection of termite entry.

### Moisture management

It is the responsibility of designer or specifier to identify moisture related risks associated with any particular building design. Wall construction design must effectively manage moisture, accounting for both the interior and exterior environments of the building, particularly in buildings that have a higher risk of wind driven rain penetration or that are artificially heated or cooled.

In addition all wall openings, penetrations, junctions, connections, window sills, heads and jambs must incorporate appropriate flashing and waterproofing. Materials, components and their installation that are used to manage moisture in framed wall construction must, at a minimum, comply with the requirements of relevant standards and the BCA.

### Structural bracing

Scyon™ Linea™ weatherboard can be used to achieve wall bracing. For more information refer to the James Hardie Structural Bracing Application Guide available at [www.accel.com.au](http://www.accel.com.au)

### Fire rated walls

Scyon™ Linea™ weatherboards clad walls can achieve fire ratings of 60/60/60 and 90/90/90 when constructed with additional fire rated linings as specified in the James Hardie fire and acoustically rated walls Application Guide & Technical Specification.

### NOTE

Use 60 x 3.15 and 75 x 3.15mm corrosion resistant bullet head nails for concealed and face fixing respectively in fire rated applications.

## FRAMING

### General

Scyon™ Linea™ weatherboard may be specified for timber-framed or steel-framed structures. Stud spacings for Scyon™ Linea™ cladding for the wind load classifications of AS 4055 'Wind Loads for Housing' are given in Table 1.

TABLE 1

MAXIMUM STUD SPACING			
WIND CLASSIFICATION		STUD SPACING	
Non-cyclonic	Cyclonic	General areas of building (mm)	Within 1200mm of building edges (mm)
N1, N2, N3	C1	600	600
N4, N5	C2, C3	600	450
N6	C4	450	300

### Timber framing

#### Dimensions

A 35mm minimum stud width is required.

#### Structural grade

Use only seasoned timber. Unseasoned timber must not be used because it is prone to shrinkage and can cause planks and frames to move.

#### Durability

'Timber used for house construction must have the level of durability appropriate for the relevant climate and expected service life and conditions including exposure to insect attacks or to moisture, which could cause decay.' Reference AS 1684.2 'Residential timber-framed construction'.

#### Frame construction

Use of timber framing must be in accordance with AS 1684 and the framing manufacturer's specifications. Stud spacings must be in accordance with Table 1.

NOTE: When using 70mm deep framing it is recommended that the Scyon™ Linea™ weatherboard be installed prior to plumbing, electrical and other services within the frame. This will prevent these services being damaged by fasteners used to install the Scyon™ Linea™ weatherboard.

### Steel framing

#### Dimensions and gauge

A 35mm minimum stud width is required. Framing members must be in the range 0.55 to 1.6mm BMT (base metal thickness).

#### Steel

Use of steel framing must be in accordance with NASH standard for Residential and Low-Rise Steel Framing Part 1: Design Criteria and the framing manufactures specifications.

Framing members must have the appropriate level of durability required to prevent corrosion.

#### Thermal Break

For steel frames, the Building Code of Australia sections J1.5 and 3.12.1 volumes 1 and 2 respectively, state for both residential and commercial buildings a thermal break with an R 0.2m<sup>2</sup> K/W must be installed behind external cladding where the cladding and internal lining make direct contact with the same steel frame. James Hardie® recommends the HardieBreak™ thermal strip. Refer to the HardieBreak™ thermal strip installation guide for more information.

Stud spacings must be in accordance with Table 1.

#### Special framing requirements

The following are special framing requirements for both timber and steel framing:

- Additional framing may be required at internal corners and sides of openings, see relevant details on the following pages.

- Extra depth lintels may be necessary for fixing of head flashing and trim. Lintels must be located in the frame flush externally to adequately support the head flashing and trim.
- Extra packers at external corners for use with Scyon™ Axent™ trim boxed corners.

#### Tolerances

Ensure frame is square and work from central datum line. Frames must be straight and true to provide a flush face to receive the Scyon™ Linea™ weatherboard. A suggested maximum tolerance of between 3mm and 4mm in any 3000mm length of frame will give best results. Scyon™ Linea™ weatherboard will not straighten excessively warped or distorted frames and any warping may still be visible after product is applied.

## PREPARATION

### HardieWrap™ weather barrier

HardieWrap™ weather barrier must be installed under Scyon™ Linea™ weatherboards in accordance with the AS/NZS 4200.2 'Pliable building membranes and underlays – Installation' and HardieWrap™ Technical Data Sheet.

HardieWrap™ weather barrier delivers a triple-shield of protection to help against external weather penetration, internal condensation build-up and external heat penetration. Additionally, it enhances the wall thermal performance, please refer to [www.jameshardie.com.au](http://www.jameshardie.com.au) or [www.accel.com.au](http://www.accel.com.au) for more information.

If using an alternate product in lieu of HardieWrap™ weather barrier, the designer must ensure that the product is fit for purpose and it has the following properties in accordance with AS/NZS 4200.1:

- Vapour barrier - low or medium
- Water barrier - high

In hot humid areas of Australia, HardieWrap™ weather barrier may not be suitable, refer to the building designer for a suitable membrane and Ask James Hardie® on 13 11 03.

Soft compressible insulation installed between the front of the wall studs and directly behind the external cladding can cause installation issues and is thus not recommended.

### Flashing

All wall openings, penetrations, intersections, connections, window sills, heads and jambs must be flashed prior to plank installation. See 'Moisture management' Section for requirements.

### Accessories

Some Scyon™ Linea™ weatherboard accessories may require installation prior to fixing of the boards. Refer to the relevant details in this document.

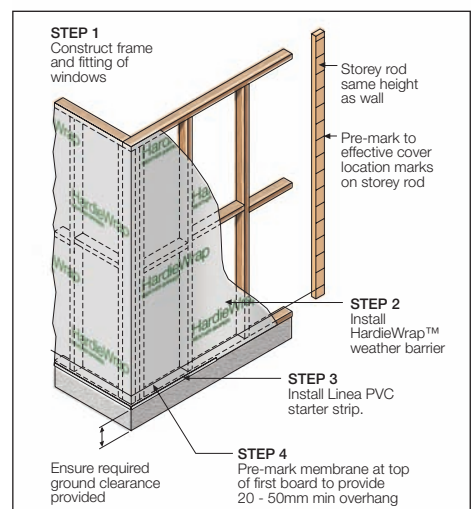

**NOTES**

1. Ensure all double studs are well nailed together, and flush at the outside face.
2. Generally external and internal corners have additional framing requirements and require that flashings and/or components are fitted prior to fixing the Scyon™ Linea™ weatherboard.
3. Ensure aluminium corner accessories are installed prior to Scyon™ Linea™ weatherboard installation.
4. Alternative methods can be used to gauge the effective cover during installation e.g. marking corner moulds or using timber blocks cut to effective cover height to locate and support boards.

**INSTALLATION**

**NOTE**

You must ensure the product is of acceptable quality prior to installation, see Important Note 3. Install the cladding as detailed below around the building, joining the boards at the tongue and groove progressively.

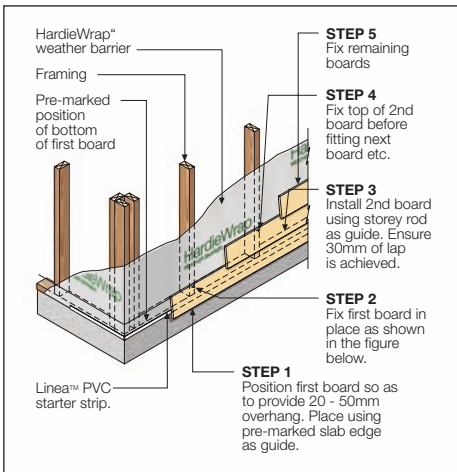

**NOTES**

1. Boards should be nailed to the studs starting from the centre of the board outwards.
2. Select an off-cut to start the second course at the corner so that joints are staggered.

**SLAB / EAVE JUNCTION**

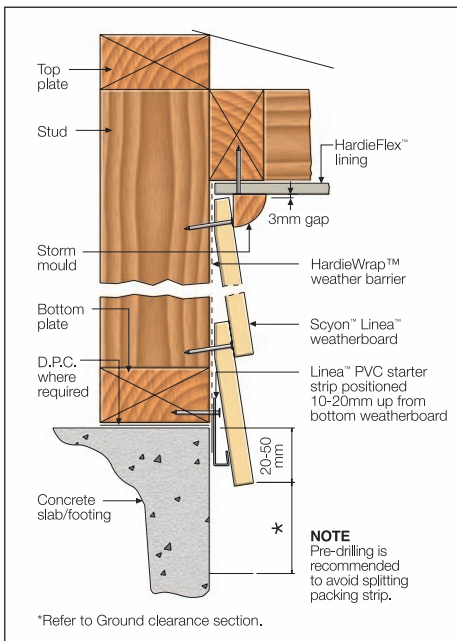

**FIXING**

Scyon™ Linea™ weatherboard is installed with 40 x 2.8mm fibre cement nails by concealed fixing as shown below. Suitable gun nails of 40mm minimum length can also be used.

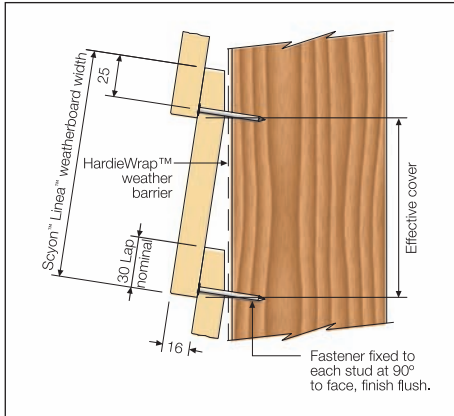

Face fixing must be provided for bracing applications as shown below.

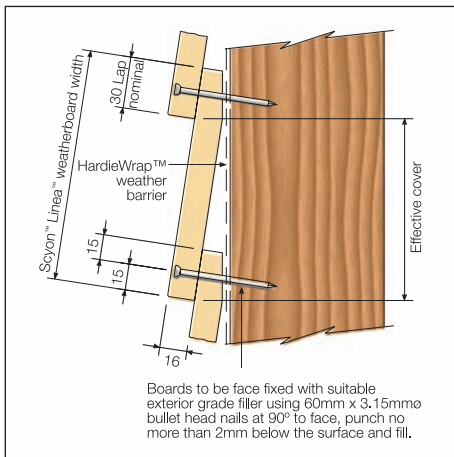

**NOTES**

1. Hold the board hard to the stud when fixing.
2. Face fixing may be added whenever site conditions create undue gaps between boards at laps. Alternatively corrosion resistant 25 mm brad nails can be used to minimise gaps by face fixing where required.
3. The minimum edge distance to the end of the board is 20mm for hand nailing and 50mm for gun nailing.
4. If fixing is to be carried out using a nail gun, ensure that the appropriate size and fastener durability is selected. Gun nailing is not recommended for face fixing applications.
5. Nail guns must be set to ensure that the nails are flush with the surface of the boards. Gun nails may require extra nailing by hand.
6. Face fixing method must be used if structural bracing required.
7. Longer fasteners may be required for fire rated applications, refer to the James Hardie Fire and Acoustically Rated Walls Application Guide.

**FASTENERS**

**Fastener durability**

Fasteners must have the appropriate level of durability required for the intended project. This is of particular importance in coastal areas, areas subject to salt spray and other corrosive environments.

Fasteners must be fully compatible with all other materials that they are in contact with to ensure the durability and integrity of the assembly.

Contact fastener manufacturers for more information.

**Fasteners for timber**

**NOTE**

The minimum edge distance to the end of the board is 20mm and 50mm for hand and gun nailing respectively.

**Hand nailing**

Scyon™ Linea™ weatherboard must be fixed to timber framing with the types of nails shown in Table 2. Refer to Scyon™ Axent™ trim Installation Instructions for trim fixing details.

TABLE 2

NAIL REQUIREMENTS FOR SCYON™ LINEA™ WEATHERBOARD	
<b>CONCEALED NAILING</b>	
40 x 2.8mm fibre cement nail	Class 3 minimum finished flush with board surface.
<b>FACE NAILING</b>	
60 x 3.15mm bullet head nails	Class 3 minimum nails may be driven through both thicknesses at board lap without pre-drilling. Stainless steel nails will require pre-drilling. Use a 3.0mm drill bit.

**Gun nailing**

A variety of gun nails are available for concealed nailing of Scyon™ Linea™ weatherboard using various guns. Nails must be a minimum of 40mm long, contact supplier for details.

**Fasteners for steel**

Scyon™ Linea™ weatherboard must be fixed to 0.55 – 1.6mm BMT domestic type steel framing with the types of screws shown in Table 3.

TABLE 3

SCREW REQUIREMENTS FOR SCYON™ LINEA™ WEATHERBOARD	
<b>CONCEALED SCREWING</b>	
40mm HardieDrive™ screw	Class 3 (hot-dipped galvanised) screw for concealed fixing to 0.80 - 1.6mm BMT steel framing.
40mm Buildex FibreTEKS®	Galvanised screw for concealed fixing to 0.55 - 0.75mm BMT steel framing. Available in Class 3 (hot-dipped galvanised).
40mm special wing screw by TRI-FIXX	For 0.55 - 1.2mm BMT steel framing. Available in Class 3 (hot-dipped galvanised) and stainless steel.
40mm fibre cement screw DPT by South Pacific Fasteners	For 0.55 - 1.2mm BMT steel framing. Available in Class 3 (hot-dipped galvanised).
<b>FACE SCREWING</b>	
52mm special wing screw by TRI-FIXX	For 0.55 - 1.2mm BMT steel framing. Available in Class 3 (hot-dipped galvanised) and stainless steel.

Fasteners should be driven flush as shown below.

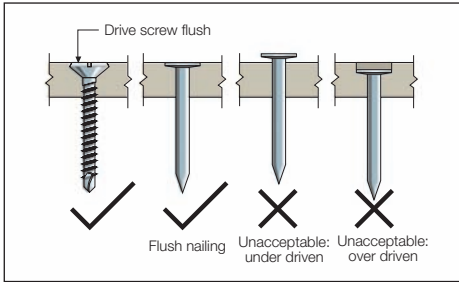

## JOINTING

The ends of Scyon™ Linea™ weatherboard are jointed off-stud by means of the tongue-and-groove joint.

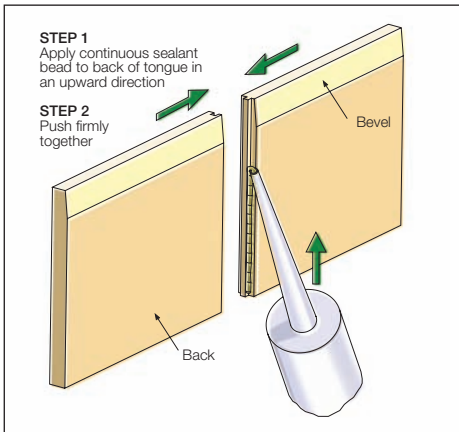
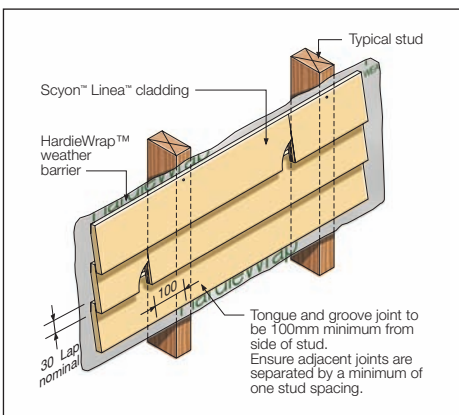

## EXTERNAL CORNERS

### Scyon™ Axent™ trim external corner

NOTE: Refer to Scyon™ Axent™ trim Installation Instructions for installation information.

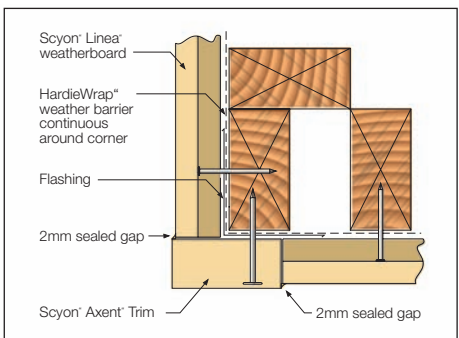

## Slimline box corner

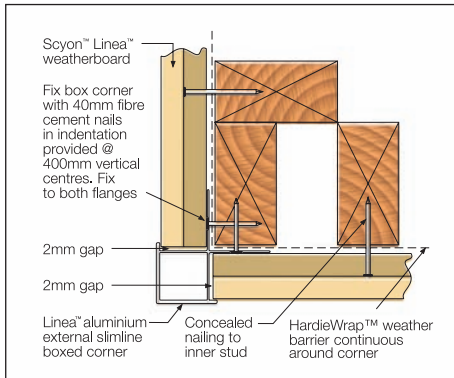
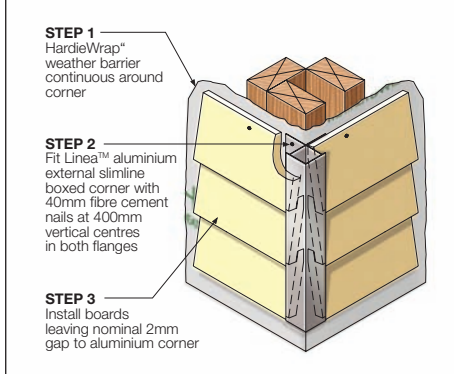

## Corner soakers

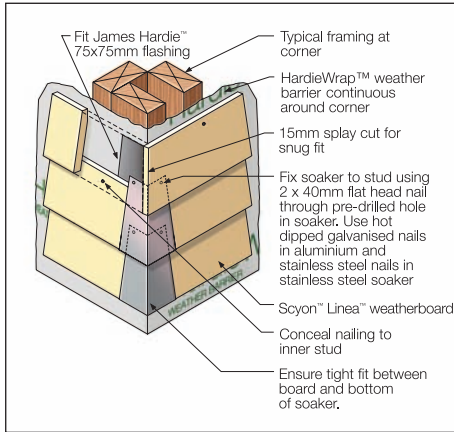

## External mitre corner

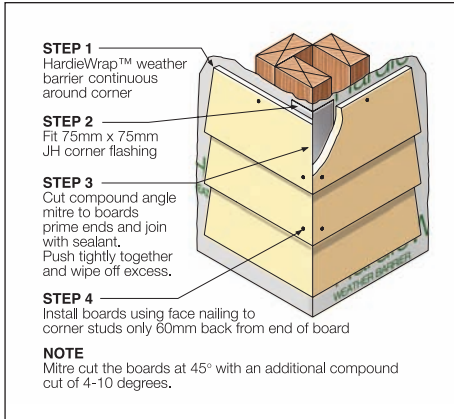

## INTERNAL CORNERS

### Scyon™ Axent™ trim internal corner

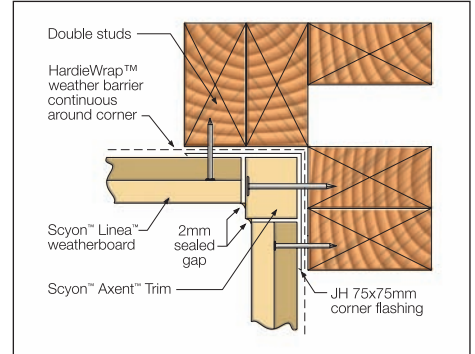

## Internal corner mould

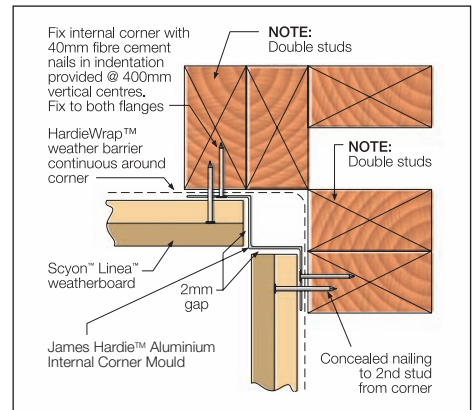
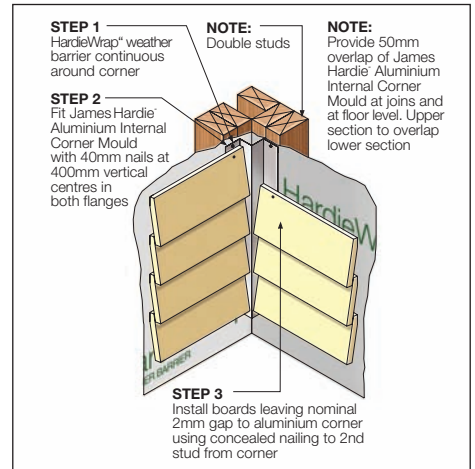

## NOTCH AND SCRIBE

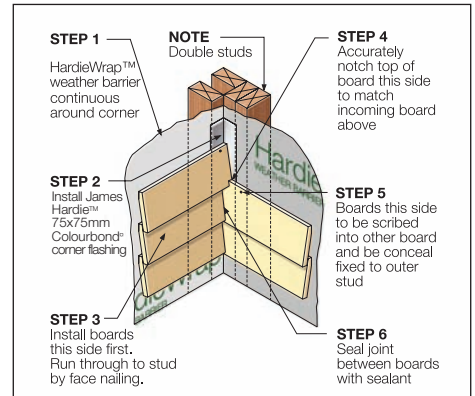

## WINDOWS

### Windows using Scyon™ Axent™ trim

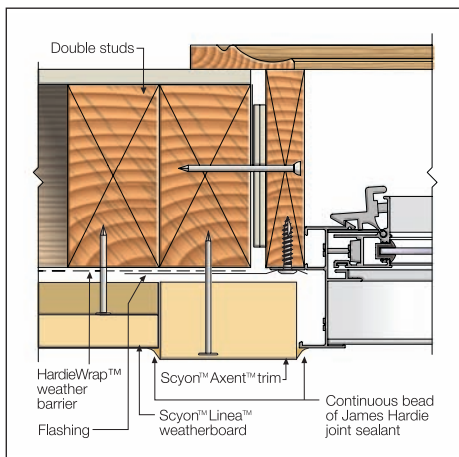
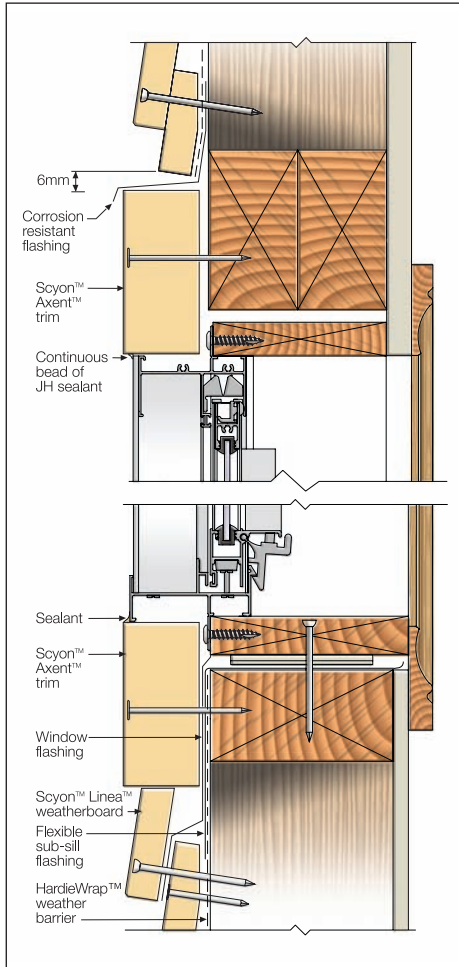

### Windows using the Linea™ Aluminium Window Adapter

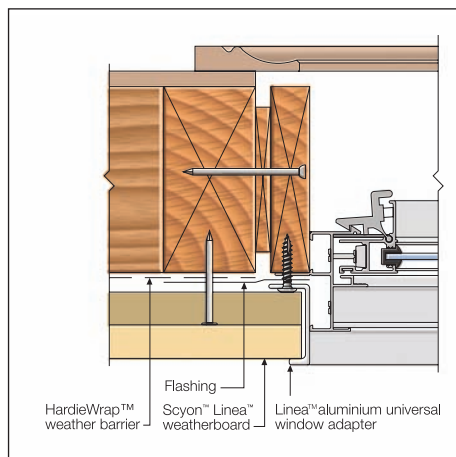
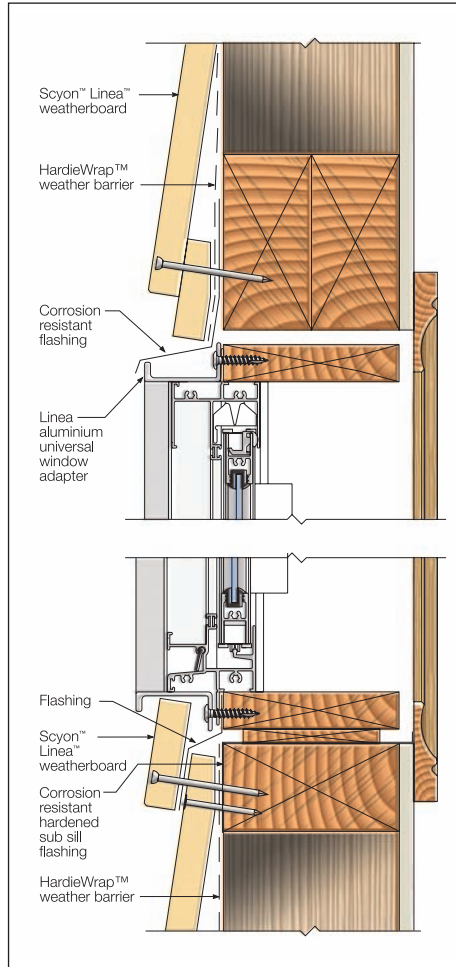

## FINISHING

### Preparation and priming

The Scyon™ Linea™ weatherboard and Scyon™ Axent™ trim are pre-primed and must be dry before painting. Punch and fill all exposed nails a maximum of 2mm below the surface of the board. For screws, ensure the head of the screw is nominally 2mm below the surface of the board.

Fill the hole with a suitable exterior grade filler, allow to cure and sand smooth. Priming of filled and sanded patches may be required in accordance with paint manufacturer's specifications.

NOTE: Care must be taken not to over-sand as it can affect the finish.

### Sealants

Application and use of sealants must comply with manufacturer's instructions. Sealants, if coated, must be compatible with the paint system. James Hardie recommends the use of James Hardie joint sealant, which is a paintable polyurethane sealant.

### Painting

Refer to the project specification for paint requirements. The Scyon™ Linea™ weatherboard and Scyon™ Axent™ trim are pre-primed must be painted within 3 months of being fixed. James Hardie recommends the application of two coats minimum of a quality acrylic paint over the pre-primed boards in accordance with the paint manufacturer's specifications. Some environments require special coatings. Painting selection and specifications are dependant on the paint chosen. Refer to the paint manufacturer for information and details of their warranty.

### Staining

Stains containing linseed oil are specifically designed for wood and may not be suitable for James Hardie cladding products, primed or unprimed. Semi-transparent stains can vary in uniformity of appearance depending on method of application and conditions and will require a high level of skill and craftsmanship to achieve a uniform appearance. Clear coats have not proven durable in exterior exposure and James Hardie considers them a maintenance item that may require application of a refurbishing sealer at regular intervals. James Hardie does not warrant the appearance or durability of semi-transparent stains and clear coats.

### MAINTENANCE

The extent and nature of maintenance will depend on the geographical location and exposure of the building. As a guide, it is recommended that basic normal maintenance tasks shall include but not be limited to:

- Washing down exterior surfaces every 6-12 months\*
- Re-applying of exterior protective finishes\*
- Maintaining the exterior envelope and connections including joints, penetrations, flashings and sealants that may provide a means of moisture entry beyond the exterior cladding.
- Ensure clearances specified in this document is maintained.
- Cleaning out gutters, blocked pipes and overflows as required.
- Pruning back vegetation that is close to or touching the building.

\*Refer to your paint manufacturer for washing down and recoating requirements related to paint performance.

## PRODUCT INFORMATION

### General

Scyon™ Linea™ weatherboard and Scyon™ Axent™ trim are a reengineered concrete formulation utilising patented technology. The basic composition is Portland cement, ground sand, cellulose fibre, water and proprietary additives.

Scyon™ Linea™ weatherboard and Scyon™ Axent™ trim are manufactured to AS/NZS 2908.2 'Cellulose-Cement Products Part 2: Flat Sheets'. Scyon™ Linea™ weatherboard and Scyon™ Axent™ trim are classified Type A, Category 3 in accordance with AS/NZS 2908.2.

For Material Safety Data Sheets (MSDS) visit [www.jameshardie.com.au](http://www.jameshardie.com.au) or Ask James Hardie™ on 13 1103.

### Durability

#### Resistance to moisture/rotting

Scyon™ Linea™ weatherboard and Scyon™ Axent™ trim has demonstrated resistance to permanent moisture-induced deterioration (rotting) by passing the following tests in accordance with AS/NZS 2908.2:

- Water permeability (Clause 8.2.2)
- Warm water (Clause 8.2.4)
- Heat rain (Clause 6.5)
- Soak dry (Clause 8.2.5).

#### Resistance to fire

Scyon™ Linea™ weatherboard and Scyon™ Axent™ trim are suitable where non-combustible materials are required in accordance with C1.12 of the Building Code of Australia.

James Hardie building products have been tested by CSIRO in accordance with AS/NZS 3837 and are classified as conforming to Group 1 material (highest and best result possible), with an average specific extinction area far lower than the permissible 250m<sup>2</sup>/kg, as referenced in Specification C1.10a of the BCA.

#### Resistance to termite attack

Based on testing completed by CSIRO Division of Forest Products and Ensis Australia James Hardie building products have demonstrated resistance to termite attack.

### Alpine regions

In regions subject to freeze/thaw conditions, all James Hardie fibre cement external cladding must be installed and painted in the warmer months of the year where the temperature does not create freeze and thaw conditions or paint issues. The cladding must be painted immediately after installation. In addition, fibre cement cladding must not be in direct contact with snow and/or ice build up for extended periods, e.g. external walls in alpine regions subject to snow drifts over winter.

Furthermore, a reputable paint manufacturer must be consulted in regards to a suitable product, specifications and warranty. The paint application must not be carried out if the air temperature or the substrate temperature is outside the paint manufacturer's recommendation including the specified drying temperature range

James Hardie external cladding products are tested for resistance to frost in accordance with AS/NZS 2908.2 Clause 8.2.3

## Scyon™ Linea™ weatherboard

### 25 YEAR WARRANTY

#### January 2012

James Hardie Australia Pty Limited ("James Hardie") warrants to the first purchaser of Scyon™ Linea™ weatherboard (**Product**) from James Hardie and the last purchaser of the Product prior to installation that, subject to compliance with the Conditions of Warranty below:

- for a period of 25 years from the date of purchase, the Product will be free from defects due to defective factory workmanship or materials; and
- for a period of 25 years from the date of purchase, the Product will be resistant to damage from cracking, moisture, rotting, fire and termites to the extent set out in James Hardie's relevant published literature current at the time of installation; and
- for a period of 12 months from the date of purchase that the accessories supplied by James Hardie will be free from defects due to defective factory workmanship or materials.

For the purposes of this warranty, a "defect" in respect of the Product means a non-compliance with AS/NZS 2908.2:2000 Cellulose-cement products - Flat sheet.

### CONDITIONS OF WARRANTY

This warranty is strictly subject to the following conditions:

- (a) James Hardie will not be liable for breach of this warranty unless the claimant provides proof of purchase of the Product and makes a written claim to James Hardie at the address set out below, either within 30 days after the defect would have become reasonably apparent or, if the defect was reasonably apparent prior to installation, then the claim must be made prior to installation.
- (b) the Product is subject to natural variation in finish as part of the manufacturing process. The builder/installer must ensure the Product meets aesthetic requirements before installation. Subject to the terms of this warranty, after installation of the Product, James Hardie is not liable for claims arising from aesthetic surface variations if such variations were, or would upon reasonable inspection have been, apparent prior to installation;
- (c) this warranty cannot be relied upon by any other person and is not transferable;
- (d) the Product must be installed and maintained strictly in accordance with the relevant James Hardie literature current at the time of installation and must be installed in conjunction with the components or products specified in the literature. To obtain copies of such literature go to or contact Ask James Hardie™ on 13 11 03. Further, all other products, including coating and jointing systems, applied to or used in conjunction with the Product must be applied or installed and maintained strictly in accordance with the relevant manufacturer's instructions and good trade practice;
- (e) the project must be designed and constructed in strict compliance with all relevant provisions of the current Building Code of Australia, regulations and standards;
- (f) if the claimant chooses to rely upon this warranty then the claimant's sole remedy under this warranty for breach of this warranty is (at James Hardie's option) that James Hardie will either supply replacement Product, rectify the affected Product or pay for the cost of the replacement or rectification of the affected Product;

(g) In the circumstances where the Australian Consumer Law does not apply in respect of the purchase of the Product, James Hardie will not be liable for any losses or damages (whether direct or indirect) including property damage or personal injury, consequential loss, economic loss or loss of profits, arising in contract or negligence or howsoever arising. Without limiting the foregoing, James Hardie will not be liable for any claims, damages or defects arising from or in any way attributable to poor workmanship, poor design or detailing, settlement or structural movement and/or movement of materials to which the Product is attached, incorrect design of the structure, acts of God including but not limited to earthquakes, cyclones, floods or other severe weather conditions or unusual climatic conditions, efflorescence or performance of paint/coatings applied to the Product, normal wear and tear, growth of mould, mildew, fungi, bacteria, or any organism on any Product surface or Product (whether on the exposed or unexposed surfaces);

(h) In the circumstances where the Australian Consumer Law does not apply in respect of the purchase of the Product, all warranties, conditions, liabilities and obligations other than those specified in this warranty are excluded to the fullest extent allowed by law;

(i) If meeting a claim under this warranty involves re-coating of Product, there may be slight colour differences between the original and replacement Product due to the effects of weathering and variations in materials over time and James Hardie is not liable for any such colour differences;

(j) In the circumstances where the Australian Consumer Law does not apply in respect of the purchase of the Product and therefore to this warranty, all expenses incurred as a result of claiming under this warranty are to be borne by the claimant.

(k) In the circumstances where the Australian Consumer Law does apply in respect of the purchase of the Product and therefore to this warranty, if James Hardie accepts or it is determined by James Hardie that the claimant has a valid claim under this warranty, James Hardie will bear the claimant's reasonable costs of claiming under this warranty. The claimant is responsible for all other costs of claiming under this warranty. All claims for such costs are to be notified to James Hardie at the address outlined below within 21 days from when the claimant first makes a claim under this warranty.

### DISCLAIMER

The recommendations in James Hardie's literature are based on good building practice but are not an exhaustive statement of all relevant information and are subject to conditions (d), (e), (g) and (h) above. Further, as the successful performance of the relevant system depends on numerous factors outside the control of James Hardie (e.g. quality of workmanship and design), James Hardie shall not be liable for the recommendations in that literature and the performance of the relevant system, including its suitability for any purpose or ability to satisfy the relevant provisions of the Building Code of Australia, regulations and standards.

## **IMPORTANT NOTE**

If you acquire goods manufactured by James Hardie as a consumer according to the Australian Consumer Law, our goods come with guarantees that cannot be excluded under the Australian Consumer Law. You are entitled to a replacement or refund for a major failure and compensation for any other reasonably foreseeable loss or damage. You are also entitled to have the goods repaired or replaced if the goods fail to be of acceptable quality and the failure does not amount to a major failure.

Any rights a consumer may have under this warranty are in addition to other rights and remedies of a consumer under a law in relation to the goods to which this warranty relates. Nothing in this document shall exclude or modify any legal rights a customer may have under the Australian Consumer Law or otherwise which cannot be excluded or modified at law.

Contact details if you wish to make a claim under this warranty: For more information or to make a claim under this warranty please Ask James Hardie™ on 13 11 03, visit [www.jameshardie.com.au](http://www.jameshardie.com.au) or [www.accel.com.au](http://www.accel.com.au), email James Hardie via our website or write to James Hardie at:

**James Hardie Australia Pty Ltd**  
**10 Colquhoun Street Rosehill NSW 2142**  
**PO Box 70 Parramatta NSW 2124**

© Copyright 2013 James Hardie Australia Pty Ltd. ABN 12 084 635 558. ™ and © denotes a trademark or registered mark owned by James Hardie Technology Limited

Ask James Hardie™  
Call 13 11 03  
[www.jameshardie.com.au](http://www.jameshardie.com.au)

