

ASSEMBLY INSTRUCTIONS

CORAL BAY DOUBLE SUN LOUNGE

MIMOSA
THE SIGNATURE COLLECTION

- Powder coated aluminium frame: White
- PVC coated sling canopy: Light grey
- Olifen padded lounge cushions: Light grey
- Five position adjustable back rest
- Size: 2m(L) x 1.6m(W) x 2.1m(H)
- Max.weight capacity per lounger: 120kgs



Tips:

We commend that the best way to extend the life of your outdoor cushions are by cleaning regularly and storing them in a cool, dry place indoors or in a storage bag whenever not in use or during rainy periods.

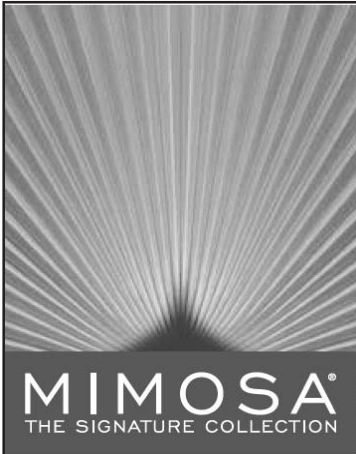

Your Coral Bay Double Sun Lounge requires assembly prior to use. It is important that you read the entire assembly instructions to become familiar with the unit before you set up the products.

Safety Warning and Precautions

WARNING: When setting up your Double Sun Lounge basic precautions should always be followed to

reduce risk of personal injury and damage to the Sun Lounge.

Read all instructions before assembly and usage this product.









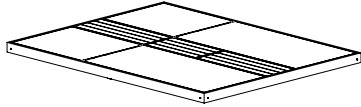
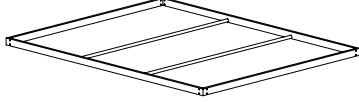
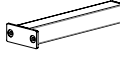

1. Select ideal location. Set out all parts on a clear and level surface prior to assembly. Ideally, the Sun Lounge should be set up in the desired location to avoid moving it after assembly.
2. Use caution. During all the processes of assembling, especially when lifting heavy or large parts, pay attention to safety.
3. Tools and Assistance. An adjustable spanner is required for assembly. It is recommended 2 people assist with assembly.
4. Check all parts before assembling the sun lounges, ensure you have all parts detailed in the parts list on Page 3.
5. Refer to assembly diagram. During assembly, refer to the assembly instructions on page 3.
6. Caution. Keep children away from work area during assembly. Do not allow children to handle parts or tools while assembling your sun lounges.

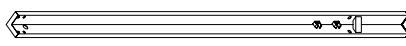

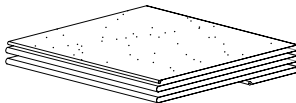
ASSEMBLY INSTRUCTIONS

CORAL BAY DOUBLE SUN LOUNGE

PARTS LIST

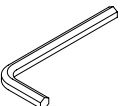
Parts #	Description	Figure	Qty
Parts A	Base		1 PC
Parts B	Top		1 PC
Parts C	Centre leg		2 PCS
Parts D	Leg		2 PCS
Parts E	Leg		2 PCS
Parts F	Round tube		2 PCS
Parts G	Round tube		2 PCS
Parts H	Sling canopy		1 PC
Parts I	Bolt (1/4"X15)		4 PCS
Parts J	Bolt (1/4"X35)		24 PCS
Parts K	Spring washer		8 PCS
Parts L	washer		8 PCS
Parts M	Cap		28 PCS
Parts N	Allen Key		1 PC

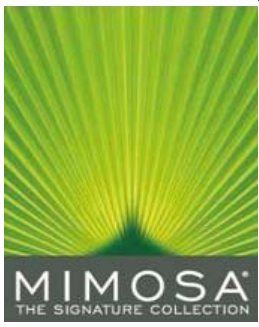

ASSEMBLY INSTRUCTIONS

CORAL BAY DOUBLE SUN LOUNGE

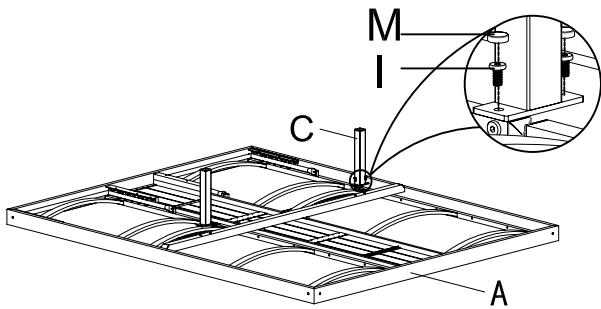

Step 1:

Place the base (Part A) on a level surface with the bottom upward. Connect the centre leg (Part C) and the seat with Bolt (Part I), small caps (Part M) can be used to cover the bolt head.

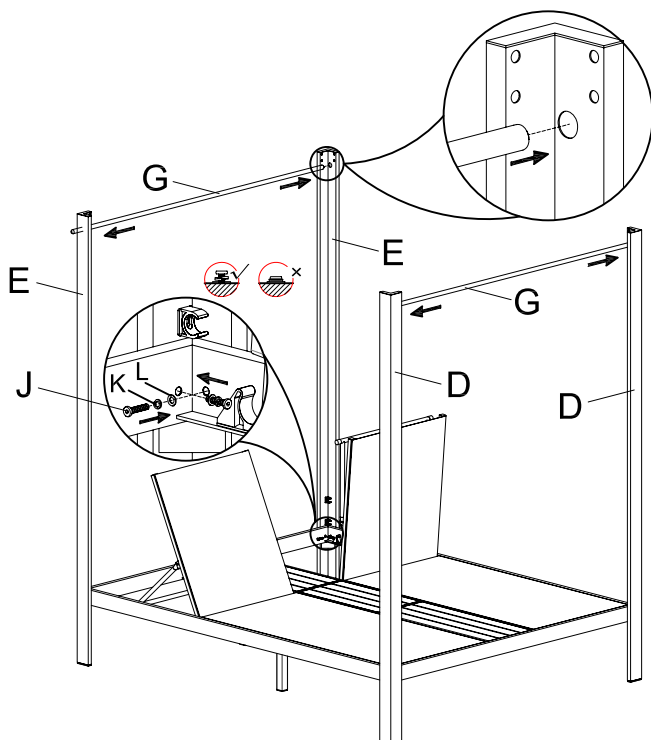

Step 2:

Place the base upright. Connect the seat and the legs (Part E & Part D) with bolt (Part J), spring washer (Part K) and washer (Part L). stick the round tube (Part G) in the hole of the legs.

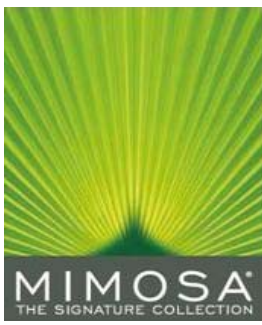

ASSEMBLY INSTRUCTIONS

CORAL BAY DOUBLE SUN LOUNGE

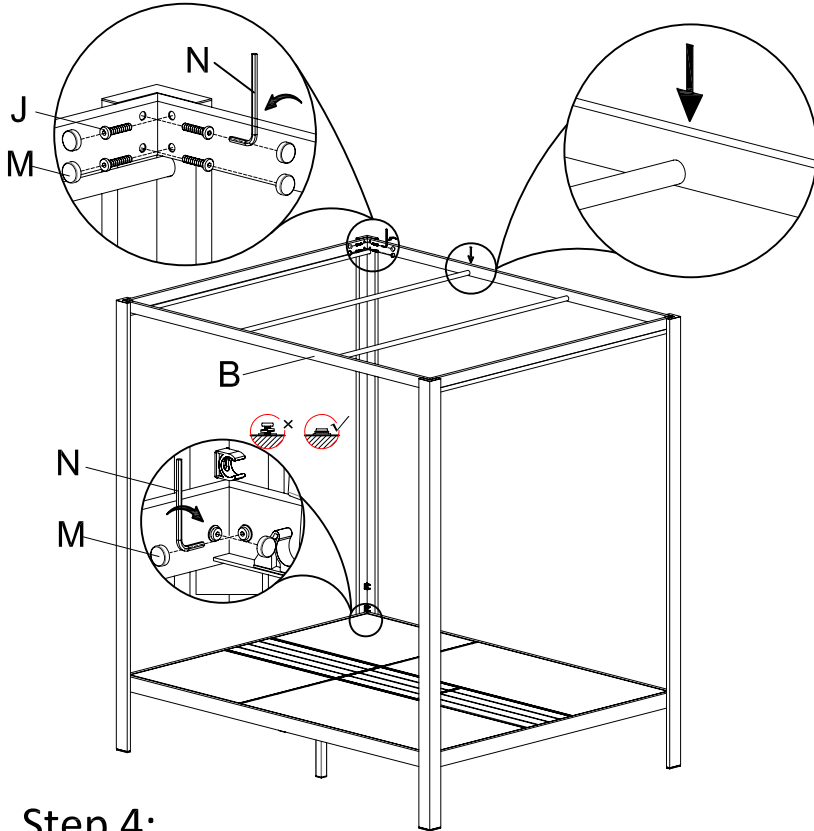

Step 3:
Connect the top(Part B) and the legs with bolt(Part J). Tighten all the bolts and Caps(Part M) can be used to cover the bolt heads.

Step 4:
Put the canopy(Part H) through the gap between the top and round tube. Insert the round tube into the canopy.

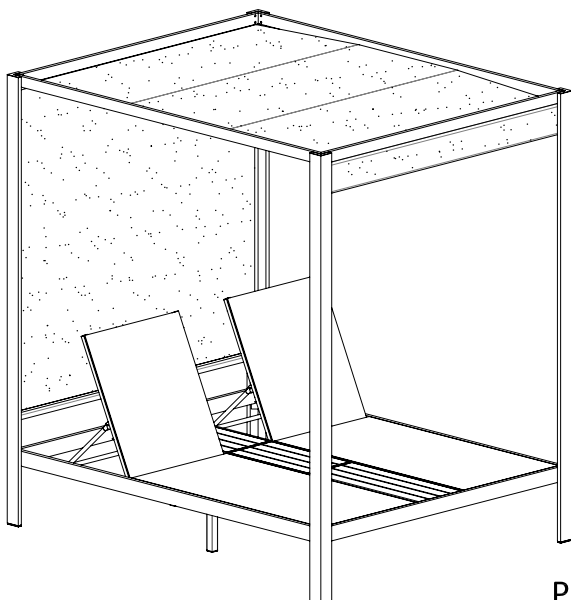
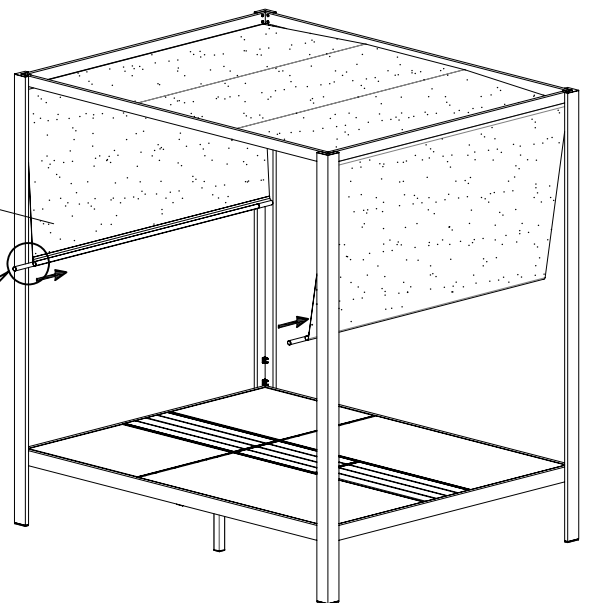
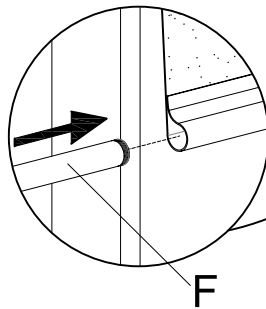

Step 5:
Tighten all the bolts.
Put the cushion on the daybed, it is ready to use.
Periodically check and make sure that all bolts are fully tightened.