

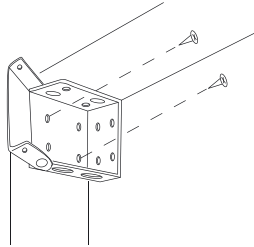

**ZONE INTERIORS OFFERS A FULL CUT TO SIZE SERVICE FOR CUT & SHORTEN - PLEASE REFER TO CUT TO SIZE ORDER SHEET IN-STORE.**

Cut to size available

### SIDE FIXING



### TOP FIXING

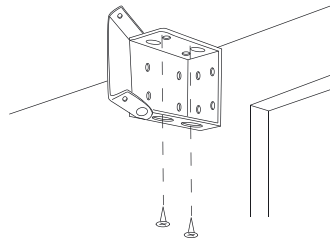

### FACE FIXING

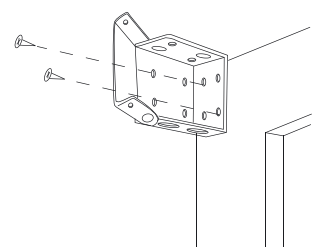

Decide on side fixing, top fixing or face fixing installation.

### STEP 1

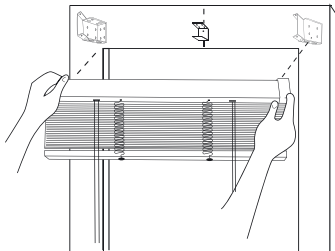

Measure window and install brackets. Fix centre bracket where applicable.

#### Centre bracket

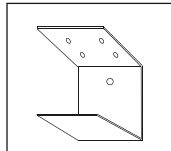

Blind width	QTY
under 90cm	0
120 - 135cm	1
150 - 240cm	2

### STEP 2

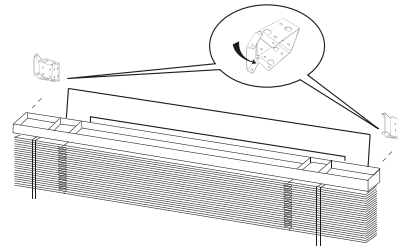

Open end brackets and install steel head rail in brackets. (Ensure cord lock and tilt cord are to the front).

### STEP 3

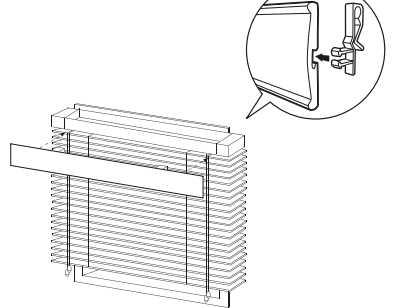

Attach valance to head rail.

### STEP 4

#### BASE CLIP APPLICATIONS

Inside mount

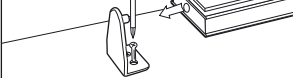

Outside mount

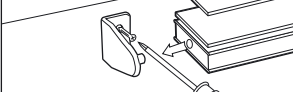

Install base clip onto bottom of window or wall depending on width of your blind.

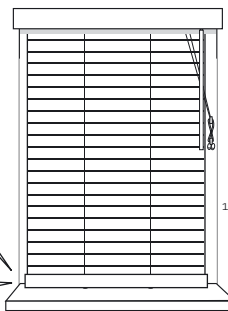

Cleat should be fitted to a wall or architrave ensuring that the cord is taut at all times. Cord tensioner must be 1600mm above floor level.

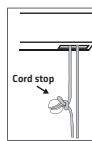

Cord stop

Floor Level

### CHECKLIST

- Child safety 'cleat' included.
- Cleat securely fitted to wall or architrave (at least 1600mm above floor level).
- Looped cord guide is kept taut around cleat at all times.
- All warning labels and stickers remain on product.
- Move cots and furniture away from window covering cords or chains.



Child safety devices included

## ! WARNING

1. A cord guide may be installed lower than 1600mm above floor level if the cord is sufficiently secured or tensioned to prevent a loop 220mm or longer from being formed.
2. If a cord guide is installed lower than 1600mm above floor level it must be designed to prevent a child from being able to remove the cord.
3. If a cleat is used to secure the cord it must be at least 1600mm above floor level because a child is capable of unwinding a cord from a cleat.

## ! WARNING

**WARNING:** Young children have died by wrapping loose curtain and blind cords or chains around their necks. Secure cords or chains with cord guides or keep them out of reach by winding them around a cleat. Move cots and furniture away from window covering cords or chains. Do not remove this label.

**WARNING:** Looped cords, looped bead chains or other flexible looped devices may cause a strangulation hazard for children under 5 years. **KEEP CORDS AND CHAINS OUT OF REACH OF CHILDREN.**

**WARNING:** To avoid creating a possible strangulation hazard for children, the window covering must be installed in such a way that a loose cord cannot form a loop 220mm or longer at a height of less than 1600mm above the floor.