

ozito

MULTI SANDER

200W

INSTRUCTION MANUAL

SPECIFICATIONS

Motor:	200W
No Load Speed:	7,000-12,000/min
Paper Fitment:	Hook & Loop
Paper Size:	145x100mm (Triangular) 125mm (Circular) 183x92mm (1/3 Sheet)
Weight:	1.38kg

ozito.com.au

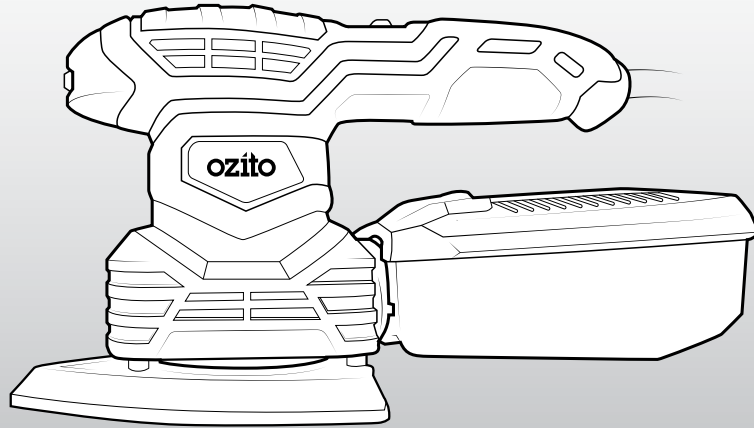

WHAT'S IN THE BOX

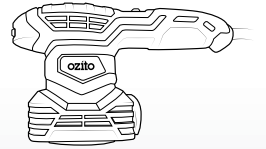

Multi Sander

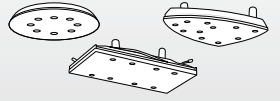

3 x Sanding Base

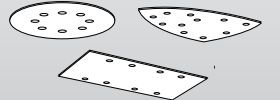

3 x Sanding Paper

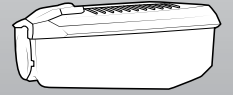

Dust Canister

3 YEAR REPLACEMENT WARRANTY

MSK-001

WARRANTY

IN ORDER TO MAKE A CLAIM UNDER THIS WARRANTY YOU MUST RETURN THE PRODUCT TO YOUR NEAREST BUNNINGS WAREHOUSE WITH YOUR BUNNINGS REGISTER RECEIPT. PRIOR TO RETURNING YOUR PRODUCT FOR WARRANTY PLEASE TELEPHONE OUR CUSTOMER SERVICE HELPLINE:

Australia 1800 069 486
New Zealand 0508 069 486

TO ENSURE A SPEEDY RESPONSE PLEASE HAVE THE MODEL NUMBER AND DATE OF PURCHASE AVAILABLE. A CUSTOMER SERVICE REPRESENTATIVE WILL TAKE YOUR CALL AND ANSWER ANY QUESTIONS YOU MAY HAVE RELATING TO THE WARRANTY POLICY OR PROCEDURE.

The benefits provided under this warranty are in addition to other rights and remedies which are available to you at law.

Our goods come with guarantees that cannot be excluded at law. You are entitled to a replacement or refund for a major failure and for compensation for any other reasonably foreseeable loss or damage. You are also entitled to have the goods repaired or replaced if the goods fail to be of acceptable quality and the failure does not amount to a major failure.

Generally you will be responsible for all costs associated with a claim under this warranty, however, where you have suffered any additional direct loss as a result of a defective product you may be able to claim such expenses by contacting our customer service helpline above.

3 YEAR REPLACEMENT WARRANTY

Your product is guaranteed for a period of 36 months from the original date of purchase. If a product is defective it will be replaced in accordance with the terms of this warranty. Warranty excludes consumable parts, for example: carbon brushes, dust bags, backing pads and sanding sheets.

WARNING

The following actions will result in the warranty being void.

- If the tool has been operated on a supply voltage other than that specified on the tool.
- If the tool shows signs of damage or defects caused by or resulting from abuse, accidents or alterations.
- Failure to perform maintenance as set out within the instruction manual.
- If the tool is disassembled or tampered with in any way.

KNOW YOUR PRODUCT

MULTI SANDER

- | | |
|---------------------------|--------------------|
| 1 Variable Speed Dial | 4 Sure Grip Handle |
| 2 Hook & Loop Sanding Pad | 5 Dust Canister |
| 3 On/Off Switch | |

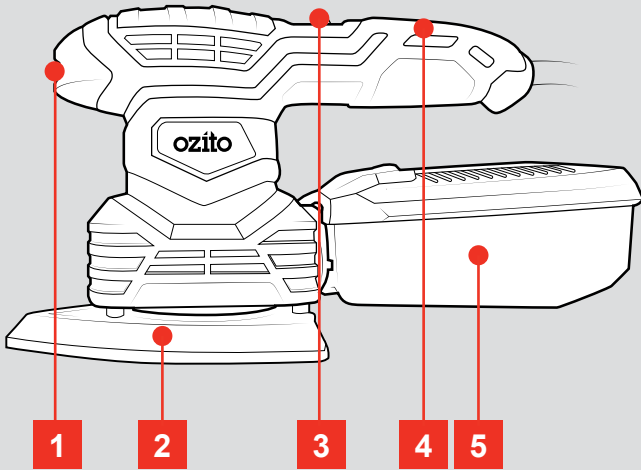

ACCESSORIES

- | | |
|--|--------------------------------------|
| 6 Random Orbital Sanding Base | 9 Sheet Sanding Paper x 1 (60Grit) |
| 7 Random Orbital Sanding Paper x 1 (120Grit) | 10 Detail Sanding Base |
| 8 Sheet Sanding Base | 11 Detail Sanding Paper x 1 (80Grit) |

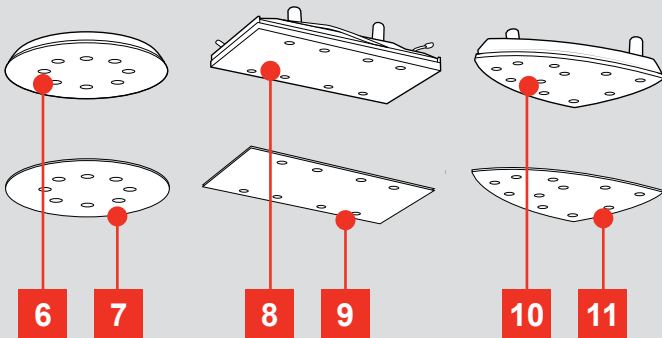

ONLINE MANUAL

Scan this QR Code with your mobile device to take you to the online manual.



SETUP & PREPARATION

1. CHANGING SANDING BASES



WARNING: ENSURE THE TOOL IS DISCONNECTED FROM THE POWER SUPPLY BEFORE PERFORMING ANY OF THE FOLLOWING OPERATIONS..

The Multi Sander comes with 3 sanding bases that can be fitted to the tool, including:

- Circular random orbital sanding base (125mm)
- Triangular detail sanding base (145x100mm)
- Rectangular 1/3 sheet sanding base (183x91mm)

Removing Sanding Bases

Note: Before removing or fitting the sanding bases, any sandpaper must be removed so that you can access the mounting screws.

- 1 Remove the 4 screws from the base of the sanding pad by rotating anti-clockwise.

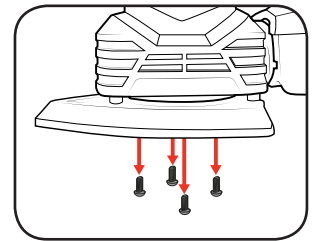

- 2 Pull the sanding base and aligning pins away from the tool to remove.

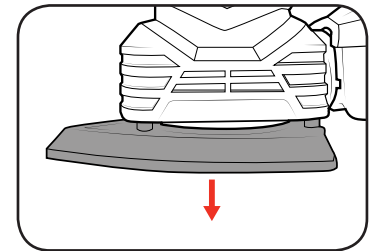

Note: The base aligning pins can sometimes get stuck in the base of the tool.

Fitting Sanding Bases

- 1 Place the sanding base onto the tool, aligning the mounting holes and the aligning pins.

Note: The circular sanding base does not require aligning pins.

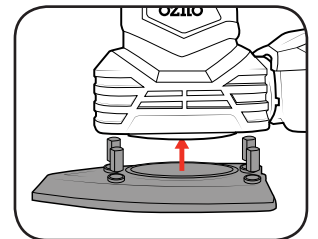

- 2 Tighten the 4 screws into the base of the sanding pad to secure in place.

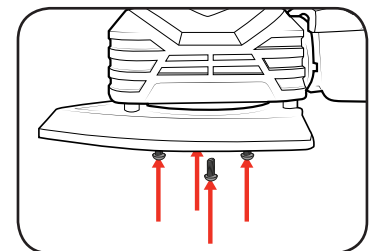

3 YEAR REPLACEMENT WARRANTY

2. FITTING SANDING PAPER

Hook and Loop Paper Fitment

- 1 Align the holes on the sanding sheet with the holes on the sanding pad and then press onto the pad.

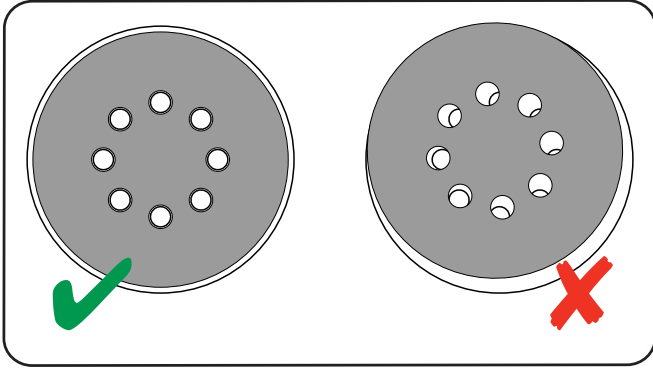

- 2 Replace the sanding sheet when it is worn.

- 3 Replace hook & loop backing pad when worn (see maintenance section).

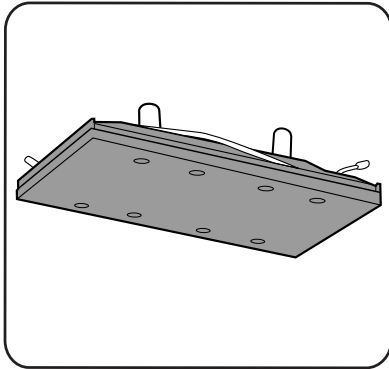

1/3 Sheet Sanding Clamp System

The rectangular sheet sanding pad also features a clamping system to allow for fitting 1/3 sheet sanding paper that does not have hook and loop fitment.

- 1 Unhook one of the clamp springs and insert the front of the sand paper, ensuring the holes in the paper align with the holes in the pad.

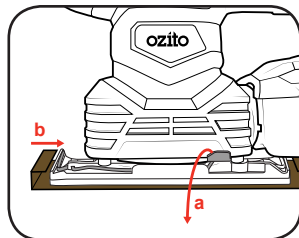

- 2 Lock the clamp spring and repeat for the 2nd spring, ensuring the paper is pulled tightly.

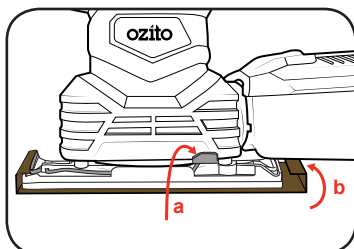

2. DUST CANISTER

Installing

- 1 Ensure that the lid is pressed tightly onto the container.

Note: You should hear a click once fitted correctly.

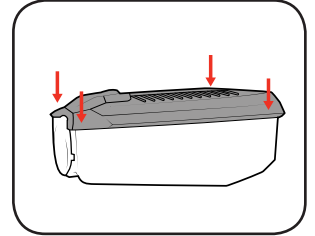

- 2 Push the dust canister hard onto the dust extraction port.

Note: You should hear a click once fitted correctly.

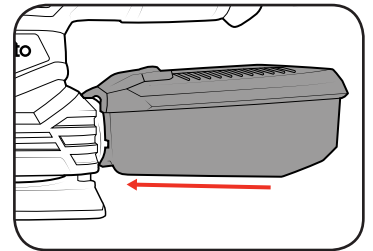

Emptying

- 1 Empty dust canister when it becomes 1/3 full for optimum dust extraction.

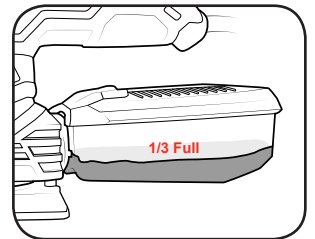

- 2 Position over a bin and press the release tab at the top of the lid. Then pull the dust canister away from the extraction port.

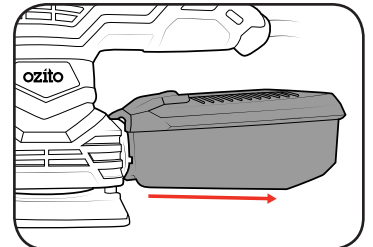

- 3 To empty, lift the lid of the dust canister over a bin and then empty.

Note: Ensure the lid is secured tightly back onto the container after emptying.

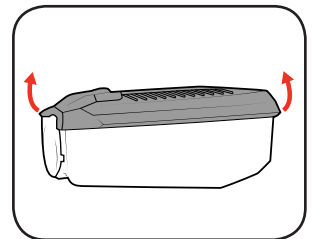

- 4 Push the dust canister hard onto the dust extraction port until it clicks into place.

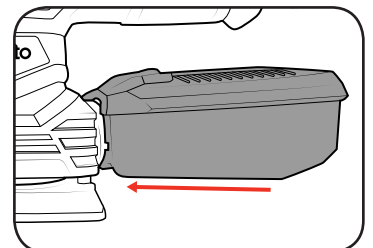

OPERATION

3. CONTROLS



WARNING: THE TOOL IS RECOMMENDED FOR USE WITH A RESIDUAL CURRENT DEVICE WITH A RATED RESIDUAL CURRENT OF 30MA OR LESS.

On/Off Switch

- 1 To switch the tool on, press the on/off switch forward into the on position.

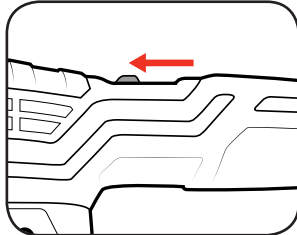

- 2 To stop the tool on, press the on/off switch backward into the off position.

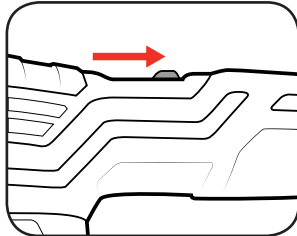

Variable Speed Dial

- 1 To increase the speed of the tool, rotate the variable speed dial to a higher number.
- 2 To decrease the speed of the tool, rotate the variable speed dial to a lower number.

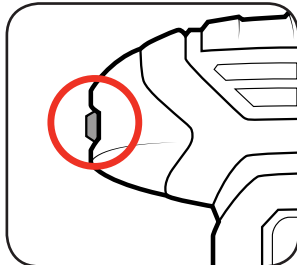

4. SANDING

- 1 Secure the material to be sanded.

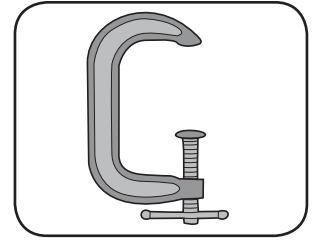

- 2 Firmly grasp the sander and turn the sander on.

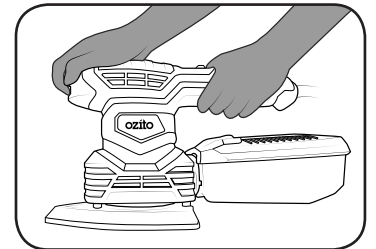

- 3 Let the motor build up to maximum speed. Gradually lower it onto the workpiece with a slight forward movement.

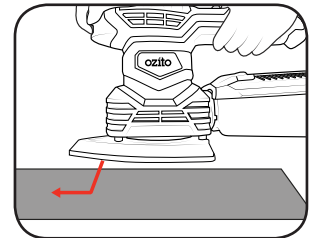

- 4 For optimum results, use either of these strokes.

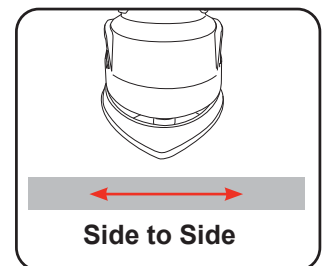
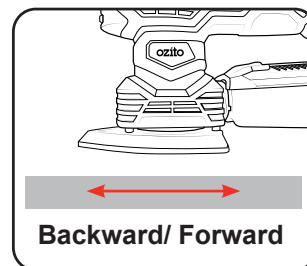

CAUTION: GUIDE THE POWER CORD DURING SANDING TO PREVENT IT BEING CAUGHT ON THE WORKPIECE OR OTHER OBJECTS.

- 5 Upon completion of the sanding operation, remove the sander from the workpiece and then turn off the sander.

MAINTENANCE

- Keep the ventilation vents of the sander clean at all times, if possible, prevent foreign matter from entering the vents.
- After each use, blow air through the sander housing to ensure it is free from all dust particles which may build up. Build up of dust particles may cause the drill to overheat and fail.
- If the enclosure of the drill requires cleaning, do not use solvents but a moist soft cloth only. Never let any liquid get inside the drill; never immerse any part of the drill into a liquid.







Replacing the Hook & Loop Backing Pad

After considerable use, the hook and loop backing pad surface will become worn, and must be replaced when it no longer offers a firm grip. The replacement backing pad can be ordered through the Special Orders Desk at any Bunnings store.

1. To replace, remove the four philips head screws by rotating anti-clockwise.
2. Place new backing pad on the tool and retighten the four philips head screws by rotating clockwise.

Note: Ozito Industries will not be responsible for any damage or injuries caused by the repair of the tool by an unauthorised person or by mishandling of the tool.

DESCRIPTION OF SYMBOLS

V	Volts	Hz	Hertz
~	Alternating current	W	Watts
/min	Revolutions or reciprocation per minute	n ₀	No load speed
mm	Millimetres	∅	Diameter
	Double insulated		Regulator compliance mark
	Warning		Read instruction manual
	Wear ear protection		Wear eye protection

CARING FOR THE ENVIRONMENT



Power tools that are no longer usable should not be disposed of with household waste but in an environmentally friendly way. Please recycle where facilities exist. Check with your local council authority for recycling advice.



Recycling packaging reduces the need for landfill and raw materials. Reuse of recycled material decreases pollution in the environment. Please recycle packaging where facilities exist. Check with your local council authority for recycling advice.

TROUBLE SHOOTING

Sparking visible through the housing air vents

A small amount of sparking may be visible through the housing vents. This is normal and does not indicate a problem.

Excessive sparking visible through the housing air vents and/or the drill failing to operate

May indicate the carbon brushes have worn out and need to be replaced. Carbon brushes should only be replaced by a qualified electrician or power tool repairer.

Sanding bases are not aligning correctly

The mounting plate at the base of the tool may need to be rotated slightly so that the holes align correctly.

Ensure there are no aligning pins stuck into the base of the tool.

For the triangular and rectangular sanding bases, also check that there are 4 aligning pins positioned correctly in the top of the sanding pad.

Sandpaper Selection

Selecting the correct grit of sandpaper is an important step in achieving optimum results. Coarse grit will remove the most material. Finer grit will produce a smoother finish. The condition of the workpiece will determine the grit of the sandpaper to be used. The higher the grit number, the finer the grade of sandpaper.

If the surface is rough, start with a coarse grit and sand until the surface is uniform. Medium grit may then be used to remove scratches left by the coarser grit. Finer grit is then used to finish the surface. Always continue sanding with each grade of sandpaper until the surface is uniform.

MATERIAL	APPROPRIATE GRIT	
	Coarse Sanding	Fine Sanding
Paintwork	180	400
Wood: Softwood	60	240
Hardwood	60	180
Veneer	240	320

Note: If intermediate sanding is required, choose a grit rating between coarse and fine. The above table is intended as a guide only. To ensure a satisfactory result, a small, inconspicuous area should first be tested to ensure the grit of sandpaper chosen is suitable for the desired finish.

Sanding Tips

Never force the sander. The weight of the sander supplies adequate pressure, allowing the sandpaper to do the work. Applying additional pressure will slow the motor, rapidly wear the sandpaper, and greatly reduce the sander speed. This will slow the removal rate and produce an inferior quality surface.

CAUTION: Excessive pressure will overload the motor, causing possible damage to the sander by overheating the motor; or damage to the workpiece.

Be sure to check your workpiece often. The sander is capable of removing material rapidly, especially with coarse paper.

The orbital action of your sander allows you to sand with the grain, or at any angle across it for most sanding jobs. In the final stages a better finish will be achieved by sanding with the grain.

Do not sand on one spot for too long. The sander's rapid action may remove too much material, creating an uneven surface.

SPARE PARTS

Spare parts can be ordered from the Special Orders Desk at your local Bunnings Warehouse.

For further information, or any parts not listed here, visit

www.ozito.com.au or contact Ozito Customer Service:

Australia 1800 069 486

New Zealand 0508 069 486

E-mail: enquiries@ozito.com.au

ELECTRICAL SAFETY



WARNING! When using mains-powered tools, basic safety precautions, including the following, should always be followed to reduce risk of fire, electric shock, personal injury and material damage.

Read the whole manual carefully and make sure you know how to switch the tool off in an emergency, before operating the tool.

Save these instructions and other documents supplied with this tool for future reference.

The electric motor has been designed for 230V and 240V only. Always check that the power supply corresponds to the voltage on the rating plate.

Note: The supply of 230V and 240V on Ozito tools are interchangeable for Australia and New Zealand.



This tool is double insulated therefore no earth wire is required.

If the supply cord is damaged, it must be replaced by an electrician or a power tool repairer in order to avoid a hazard.

Note: Double insulation does not take the place of normal safety precautions when operating this tool. The insulation system is for added protection against injury resulting from a possible electrical insulation failure within the tool.

Using an Extension Lead

Always use an approved extension lead suitable for the power input of this tool. Before use, inspect the extension lead for signs of damage, wear and ageing. Replace the extension lead if damaged or defective.

When using an extension lead on a reel, always unwind the lead completely. Use of an extension lead not suitable for the power input of the tool or which is damaged or defective may result in a risk of fire and electric shock.

GENERAL POWER TOOL SAFETY WARNINGS



WARNING! Read all safety warnings and all instructions. Failure to follow the warnings and instructions may result in electric shock, fire and/or serious injury.

Save all warnings and instructions for future reference. The term "power tool" in the warnings refers to your mains-operated (corded) power tool or battery-operated (cordless) power tool.

1. Work area safety

- Keep work area clean and well lit. Cluttered or dark areas invite accidents.
- Do not operate power tools in explosive atmospheres, such as in the presence of flammable liquids, gases or dust. Power tools create sparks which may ignite the dust or fumes.
- Keep children and bystanders away while operating a power tool. Distractions can cause you to lose control.

2. Electrical safety

- Power tool plugs must match the outlet. Never modify the plug in any way. Do not use any adapter plugs with earthed (grounded) power tools. Unmodified plugs and matching outlets will reduce risk of electric shock.
- Avoid body contact with earthed or grounded surfaces, such as pipes, radiators, ranges and refrigerators. There is an increased risk of electric shock if your body is earthed or grounded.
- Do not expose power tools to rain or wet conditions. Water entering a power tool will increase the risk of electric shock.
- Do not abuse the cord. Never use the cord for carrying, pulling or unplugging the power tool. Keep cord away from heat, oil, sharp edges or moving parts. Damaged or entangled cords increase the risk of electric shock.
- When operating a power tool outdoors, use an extension cord suitable for outdoor use. Use of a cord suitable for outdoor use reduces the risk of electric shock.
- If operating a power tool in a damp location is unavoidable, use a residual current device (RCD) protected supply. Use of an RCD reduces the risk of electric shock.

3. Personal safety

- Stay alert, watch what you are doing and use common sense when operating a power tool. Do not use a power tool while you are tired or under the influence of drugs, alcohol or medication. A moment of inattention while operating power tools may result in serious personal injury.
- Use personal protective equipment. Always wear eye protection. Protective equipment such as dust mask, non-skid safety shoes, hard hat, or hearing protection used for appropriate conditions will reduce personal injuries.

- Prevent unintentional starting. Ensure the switch is in the off-position before connecting to power source and/or battery pack, picking up or carrying the tool. Carrying power tools with your finger on the switch or energising power tools that have the switch on invites accidents.
 - Remove any adjusting key or wrench before turning the power tool on. A wrench or a key left attached to a rotating part of the power tool may result in personal injury.
 - Do not overreach. Keep proper footing and balance at all times. This enables better control of the power tool in unexpected situations.
 - Dress properly. Do not wear loose clothing or jewellery. Keep your hair, clothing and gloves away from moving parts. Loose clothes, jewellery or long hair can be caught in moving parts.
 - If devices are provided for the connection of dust extraction and collection facilities, ensure these are connected and properly used. Use of dust collection can reduce dust-related hazards.
- ## 4. Power tool use and care
- Do not force the power tool. Use the correct power tool for your application. The correct power tool will do the job better and safer at the rate for which it was designed.
 - Do not use the power tool if the switch does not turn it on and off. Any power tool that cannot be controlled with the switch is dangerous and must be repaired.
 - Disconnect the plug from the power source and/or the battery pack from the power tool before making any adjustments, changing accessories, or storing power tools. Such preventive safety measures reduce the risk of starting the power tool accidentally.
 - Store idle power tools out of the reach of children and do not allow persons unfamiliar with the power tool or these instructions to operate the power tool. Power tools are dangerous in the hands of untrained users.
 - Maintain power tools. Check for misalignment or binding of moving parts, breakage of parts and any other condition that may affect the power tool's operation. If damaged, have the power tool repaired before use. Many accidents are caused by poorly maintained power tools.
 - Keep cutting tools sharp and clean. Properly maintained cutting tools with sharp cutting edges are less likely to bind and are easier to control.
 - Use the power tool, accessories and tool bits etc. in accordance with these instructions, taking into account the working conditions and the work to be performed. Use of the power tool for operations different from those intended could result in a hazardous situation.
- ## 5. Service
- Have your power tool serviced by a qualified repair person using only identical replacement parts. This will ensure that the safety of the power tool is maintained.

MULTI SANDER SAFETY WARNINGS



WARNING!

- Hold power tool by insulated gripping surfaces, because the sanding pad may contact its own cord. Cutting a "live" wire may make exposed metal parts of the power tool "live" and could give the operator an electric shock.

Recommendation that the tool always be supplied via a residual current device with a rated residual current of 30 mA or less.

Unplug the sander before changing accessories. Accidental start-ups may occur if the sander is plugged in while changing an accessory.

Disposing of dust. Be extremely careful of dust disposal, materials in fine particle form may be explosive. Do not throw sanding dust on an open fire. Spontaneous combustion, may in time, result from a mixture of oil or water with dust particles.

Always wear eye protection and a dust mask for dusty applications and when sanding overhead. Sanding particles can be absorbed by your eyes and inhaled easily and may cause health complications.

Use special precautions when sanding chemically pressure treated timber, paint that may be lead based, or any other materials that may contain carcinogens. A suitable breathing respirator and protective clothing must be worn by all persons entering the work area. Work should be sealed by plastic sheeting and persons not protected should be kept out until work area is thoroughly cleaned.

Do not 'wet sand' with this sander. Liquids entering the motor housing are an electrical shock hazard.

Do not use sandpaper intended for larger sanding pads. Larger sandpaper will extend beyond the sanding pad causing snagging, tearing of the paper or kick-back. Extra paper extending beyond the sanding pad can also cause serious lacerations.



WARNING!

Some dust created by power sanding, sawing, grinding, drilling and other construction activities contain chemicals known to cause cancer, birth defects or other reproductive harm.

Some examples of these chemicals are:

- Lead from lead-based paints;
- Crystalline silica from bricks, cement and other masonry products, and;
- Arsenic and chromium from chemically-treated timber.

Your risk from these exposures varies, depending on how often you do this type of work. To reduce your exposure to these chemicals: work in a well ventilated area and work with approved safety equipment, such as dust masks that are specially designed to filter out microscopic particles.