



360° REACH™

Cyclonic Vacuum

Model # DD360



1·2·3...

USER MANUAL



2 Year Warranty

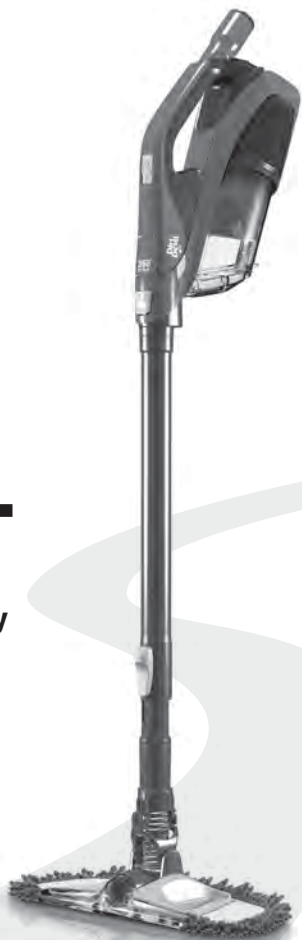

LET'S GO.™

TABLE OF CONTENTS



1·2·3...

Quick Start Assembly 6



Tools 8

Using the tools 10

How to 12

Empty the dirt cup 12

Clean the rinsable filter 13

Clean the exhaust filter 14

Clean the cyclonic filter assembly 15

Clean the brush roll 16

Store your unit 16



Troubleshooting 17

Technical Specifications 18

WARNING

**IMPORTANT: READ CAREFULLY BEFORE ASSEMBLY AND USE.
THIS PRODUCT IS INTENDED FOR HOUSEHOLD USE ONLY.
IF USED COMMERCIALY WARRANTY IS VOID.**

When using the cleaner, basic safety precautions should always be observed, including the following:

1. Only use the vacuum cleaner indoors on dry surfaces.
2. Turn off the on/off switch on the vacuum cleaner controls before disconnecting or connecting from the mains supply.
3. Always unplug the vacuum cleaner before connecting or disconnecting the vacuum hose and accessories.
4. Children should be supervised to ensure that they do not play with the appliance.
5. This appliance is not intended for use by children and persons with reduced physical, sensory or mental capabilities or lack of experience and knowledge, unless they have been given supervision or instruction concerning use of the appliance in a safe way and understands the hazards involved.
6. Cleaning and maintenance shall not be made by children.
7. The appliance should only be used as described in this user guide.
8. Only Dirt Devil recommended attachments should be used with this appliance.
9. Do not use this vacuum cleaner if it has been dropped, damaged, left outdoors or dropped into water. Do not use this vacuum cleaner with a damaged cord or plug. If the supply cord is damaged call us on AU: 1300 361 505 / NZ: 0800 800 900 for your nearest Dirt Devil authorised service agent.
10. Do not pull or carry this appliance by the cord. Do not use the cord as a handle, close a door on the cord or pull the cord around sharp edges or corners. Do not run the vacuum cleaner over the cord. Keep the cord away from heated surfaces.
11. Do not handle the plug or the vacuum cleaner with wet hands.
12. Keep hair, loose clothing, fingers and all parts of the body away from openings and moving parts.
13. Do not pick up any hot coals, ash, cigarette butts, matches or any hot, smoking or burning objects.
14. Do not pick up any flammable or combustible materials (lighter fluid, petrol, kerosene etc.) or use in the presence of explosive liquids or vapours.
15. Do not vacuum harmful or toxic material (chlorine, bleach, ammonia, drain cleaner etc.).
16. Do not vacuum hard or sharp objects such as glass, nails, screws, coins etc.
17. Do not vacuum plaster dust, concrete dust or any other building or vitreous materials.
18. Do not vacuum flour, baking soda or any other powder-based carpet refresher or deodoriser.
19. Store the vacuum cleaner in a cool, dry area.
20. Use only SAA approved 10amp extension cords. Non-approved cords may overheat. Care should be taken to arrange the cord so that the cord cannot be tripped over.

21. Do not put any objects into openings. Do not use with any openings blocked and do not restrict airflow. Keep all openings free of dust, lint, hair or anything that might reduce airflow.
22. Do not use the vacuum cleaner with blocked filters and without all of the filters in place.
23. Take extra care when positioning the vacuum cleaner on the stairs.
24. Keep vacuuming area well lit.

WARNING: Always switch off and unplug the vacuum cleaner from the electrical socket before assembling, opening or emptying the dirt container, or before connecting/disconnecting the attachments.

CAUTION: The vacuum cleaner is a very powerful unit. Before plugging the cord into the electrical socket, make sure the switch is in the 'off' position.

IMPORTANT: If the inlet or wand is blocked, switch off the vacuum cleaner and remove the blockage(s) before re-starting the vacuum cleaner.

IMPORTANT: Dirt Devil recommends the use of Residual Current Device Rating of 30mA or less.

NOTE: If the supply cord is damaged it must be replaced by the manufacturer, or a similarly qualified person in order to avoid hazard, or invalidating the warranty.

DAMAGE TO THE VACUUM CLEANER CAUSED AS A DIRECT RESULT OF NOT ADHERING TO THE GENERAL SAFETY INFORMATION AND THE INSTRUCTIONS IN THIS USER GUIDE INVALIDATES THE WARRANTY.

This machine is intended for household use only, and NOT for commercial or industrial use.

PLEASE KEEP THESE INSTRUCTIONS FOR FURTHER USE.



NOTICE

A THERMAL PROTECTOR HAS BEEN DESIGNED INTO YOUR CLEANER TO PROTECT IT FROM OVERHEATING. WHEN THE THERMAL PROTECTOR ACTIVATES THE CLEANER WILL STOP RUNNING.

If this happens proceed as follows:

1. Turn cleaner OFF and unplug it from the electrical outlet.
2. Empty dirt cup.
3. Inspect the nozzle opening, dirt cup inlet and filter. Clear obstructions if present.
4. When cleaner is unplugged and motor cools for 30 minutes, the thermal protector will deactivate and cleaning may continue.

If the thermal protector continues to activate after following the above steps, your cleaner needs servicing.



IMPORTANT

IT IS VERY IMPORTANT THAT FILTERS ARE KEPT CLEAN TO OBTAIN MAXIMUM PERFORMANCE FROM YOUR VACUUM CLEANER. NOT CLEANING AND NOT REPLACING YOUR FILTERS REGULARLY CAN REDUCE THE SUCTION POWER AND CAUSE OVERHEATING AND PERMANENT DAMAGE TO THE VACUUM CLEANER.

QUICK START



1

POP THE DIRT CUP IN AT AN ANGLE, BOTTOM END FIRST. IT'LL CLICK.

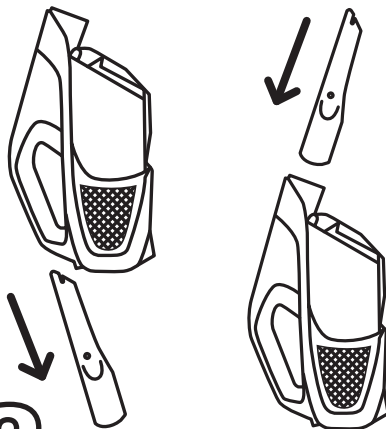

2

REMOVE CREVICE TOOL FROM HANDLE THEN SLIDE IT IN HERE.

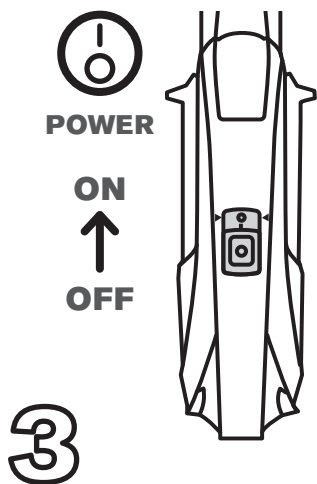

3

PLUG IN AND SLIDE UP HERE TO POWER ON (I=ON), SLIDE SWITCH TO OFF (O=OFF).

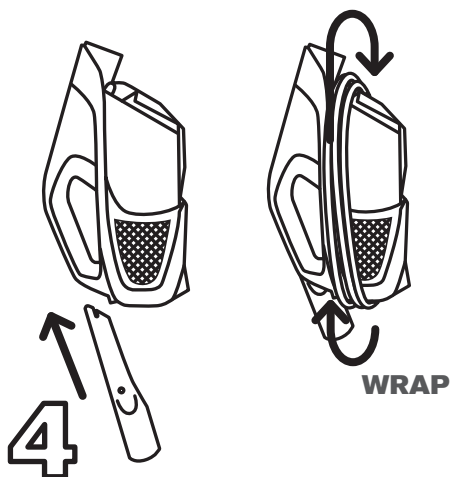

4

WHEN FINISHED CLEANING, REPLACE CREVICE TOOL INTO HANDLE AND WRAP THE CORD AROUND BOTH ENDS OF THE VACUUM. ATTACH THE PLUG END TO THE CORD.

TOOLS

⚠ CAUTION

To avoid injury, particularly to face and head, keep hair, loose clothing, fingers, and all parts of the body away from revolving brush.

⚠ WARNING

Unplug before connecting any powered accessories.



CREVICE TOOL: use in tight spaces, corners, cars and along edges in such places as drawers, upholstered furniture, stairs and baseboards.

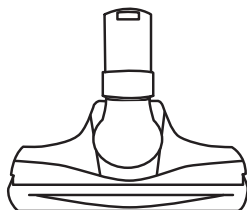

POWERED STAIR AND UPHOLSTERY TOOL: use on carpeted stairs, upholstery and in your car. It swivels 180° for convenient cleaning.

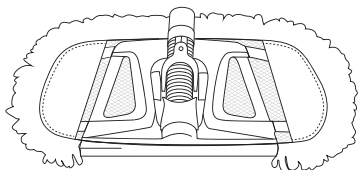

VAC+DUST HARD FLOOR TOOL WITH SWIPES™ WASHABLE MICROFIBRE PAD: vacuum and dust most hard floor surfaces.

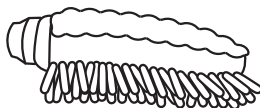

VAC+DUST™ ABOVE FLOOR TOOL WITH SWIPES™ WASHABLE MICROFIBRE PAD: vacuum and dust air ducts, shelving, ceiling fans, or hard-to-reach areas.

TOOLS

⚠ CAUTION

Not to be used for grooming a pet.

⚠ WARNING

To reduce the risk of personal injury -
Unplug before cleaning or servicing.

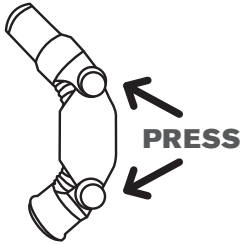

PIVOT EXTENSION TOOL: use with above floor, fan or crevice tool for improved cleaning. Press silver buttons for desired angle.

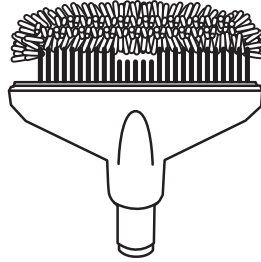

FAN TOOL: best tool for cleaning ceiling fans. Vacuum and dust fan blades for easy clean up.

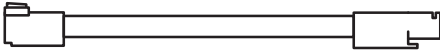

POWERED WAND: provides power to carpet nozzle and extended reach for above and hard floor cleaning.

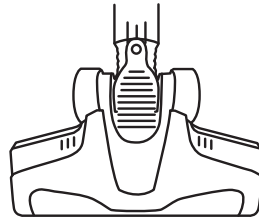

POWERED CARPET NOZZLE: great for carpets, area rugs and high traffic areas.

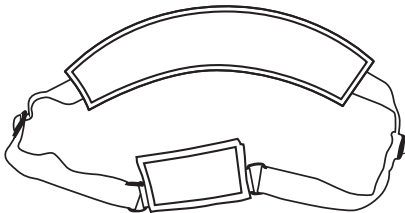

SHOULDER STRAP: allows for additional flexibility and support to clean around the home.

USING THE TOOLS

ABOVE FLOOR CLEANING

Easily clean cracks, crevices and tight places. Vacuum and dust hard surfaces including shelving, fans, vents and lighting.

CREVICE TOOL: easily cleans cracks, crevices and tight places.



VAC+DUST™ ABOVE FLOOR TOOL WITH SWIPES™ WASHABLE MICROFIBRE PAD: use for ceiling fans, air ducts or hard-to-reach areas.

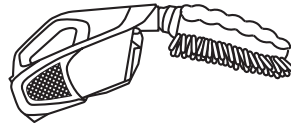

PIVOT EXTENSION TOOL: extend and pivot to clean hard-to-reach areas, corners, crevices and more.

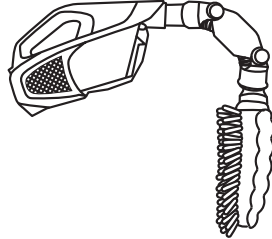
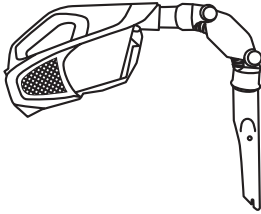

WAND: use wand to extend your reach for detailed cleaning in vents and on furniture surfaces.

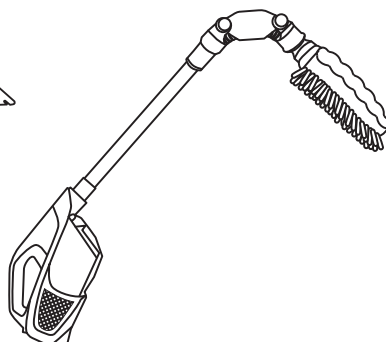
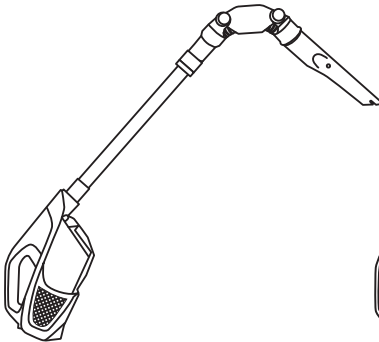

USING THE TOOLS

STAIR, UPHOLSTERY & CAR CLEANING

POWERED STAIR & UPHOLSTERY TOOL: Make stair cleaning easy. Use the Powered Stair and Upholstery Tool for carpeted stairs. It swivels 180° for convenient cleaning. For hard surfaced stairs use the crevice tool or SWIPES™ hard floor tool. Also, the tools work great for cleaning your car.

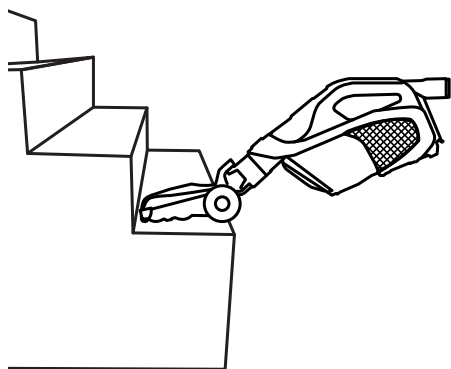
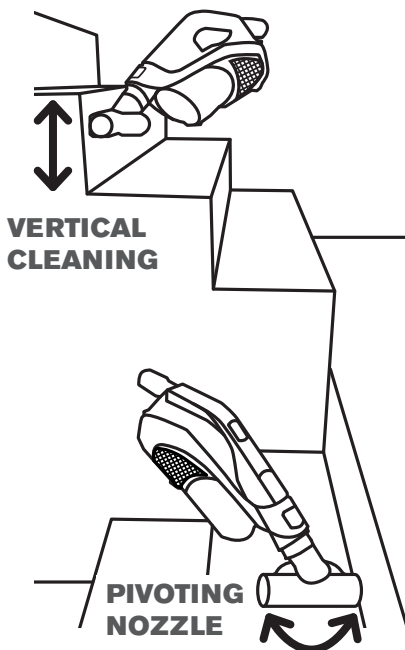

POWERED CARPET NOZZLE: Use the Powered Carpet Nozzle to tackle stairs, upholstery and area rugs.

SHOULDER STRAP: Wrap velcro around vacuum handle, then place strap on shoulder.

⚠ CAUTION

Use extra care when cleaning on stairs. Do not place cleaner on stairs or furniture, as it may result in injury or damage.

⚠ CAUTION

To avoid injury, particularly to face and head, keep hair, loose clothing, fingers, and all parts of the body away from revolving brush.

USING THE TOOLS

⚠️ WARNING

To reduce the risk of personal injury - Unplug before cleaning or servicing. Do not use vacuum without dirt cup or filters in place.

HARD FLOOR CLEANING WITH SWIPES™

Vac+Dust Floor Tool with SWIPES™ Washable Microfibre Dusting Pad picks up dirt, dust, debris & pet hair.

Works great on sealed hard floor surfaces such as tile, wood, linoleum and others.

1. Place dusting pad onto one end of the flexible dust head. Slide other pocket of dusting pad onto dust head starting at the back.
2. SWIPES™ Microfibre dusting pad picks up fine dirt, dust and pet hair while the vacuum gets larger debris.

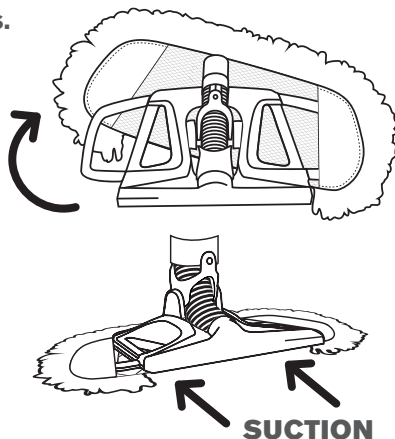

HOW TO

EMPTY THE DIRT CUP

1. Press the Dirt Cup Lid latch.
2. Ditch the dirt. Give it a shake to remove any debris.
3. Close the lid until the latch clicks.

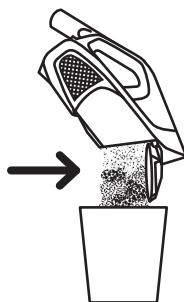

This would be a good point to check the condition of your filters. Dirty? Check out pages 14 and 15 for cleaning steps of each filter.

HOW TO

WARNING

To reduce the risk of personal injury - Unplug before cleaning or servicing.

CLEAN THE RINSABLE FILTER

1. Press the Dirt Cup release button.

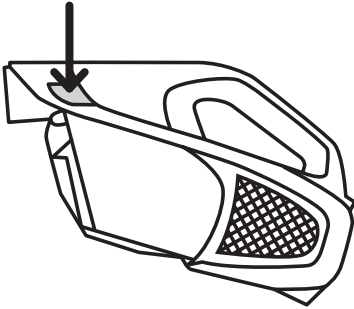

2. Twist clockwise and pull the Filter Frame out.

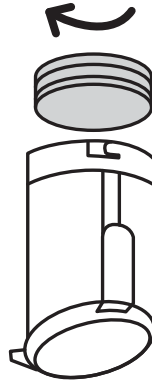

TIP: Place thumb and finger in the grooves (x) then rotate clockwise to remove, you will hear it click.

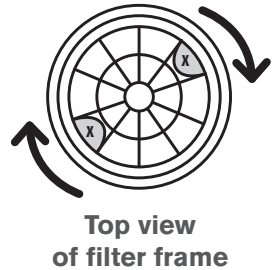

3. Rinse filter with water until the dirt disappears. Shake it out and then let it dry for 24 hours or until completely dry.

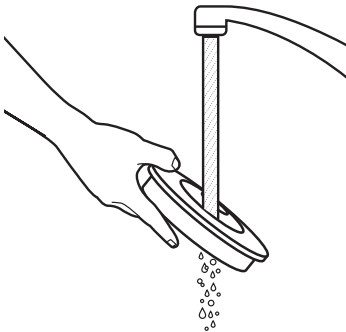

4. Put the dry filter back in by aligning the tabs and twist anti-clockwise into place. You will hear a click when the filter is secured back in its place.

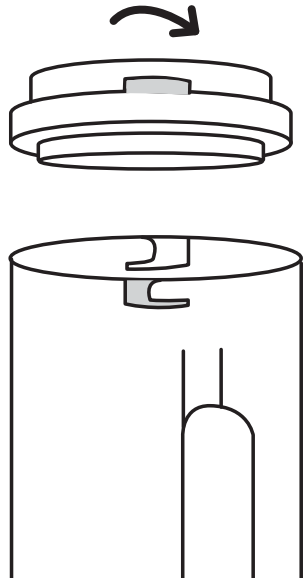

NOTE: Do not use your vacuum cleaner with blocked filters and without all the filters in place.

HOW TO

CLEAN THE EXHAUST FILTER

1. Press the silver Exhaust Cover release button and rotate out.

2. Rinse with water from both sides and let dry for 24 hours or until completely dry.

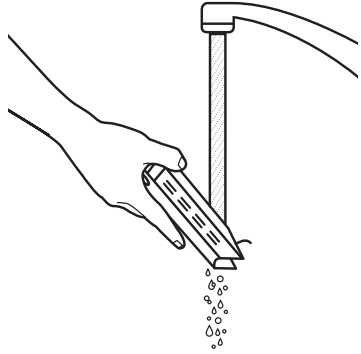
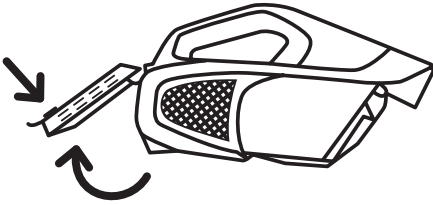

3. Put the dry filter back and click into place.

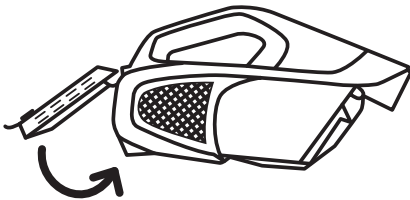

CLICK



ANY OTHER SERVICING SHOULD BE DONE BY A DIRT DEVIL AUTHORISED SERVICE AGENT. If appliance is not working as it should, has been dropped, damaged, left outdoors, or dropped into water, call us on AU: 1300 361 505 / NZ: 0800 800 900.

HOW TO

CLEAN THE CYCLONIC FILTER ASSEMBLY

1. Press the Dirt Cup release button.

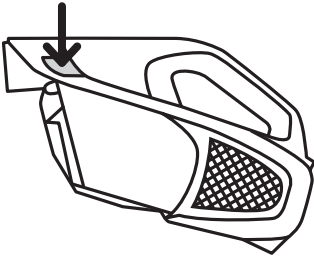

2. Twist clockwise and pull the Filter Frame out.



TIP: Place thumb and finger in the grooves (x) then rotate clockwise to remove, you will hear it click.

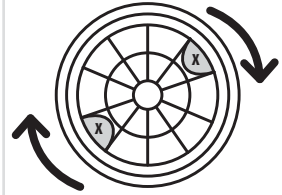

Top view of filter frame

3. Pull out the red cyclone, wipe it clean.

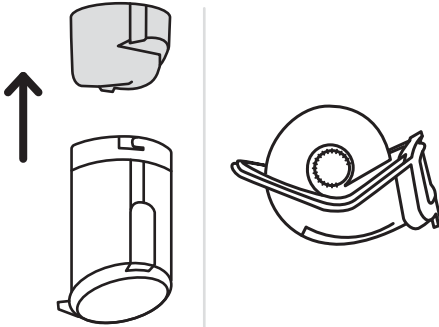

4. Line up the Cyclonic Filter Assembly tab and push back into place.

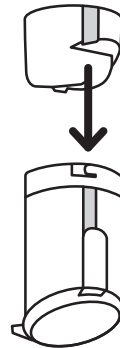

5. Put the filter back in by aligning the tabs and twist anti-clockwise into place. You will hear a click when the filter is secured back in its place.

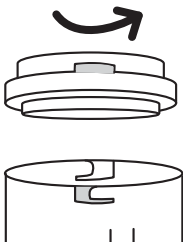

HOW TO

WARNING

To reduce the risk of personal injury from moving parts-
Unplug before servicing.

CLEANING THE BRUSHROLLS:

STAIR TOOL

1. Turn the Stair Tool over.
Remove any hair and debris
from the brushroll.

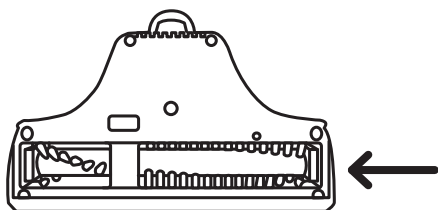

POWERED CARPET NOZZLE

1. Turn the Carpet Nozzle over.
Remove any hair and debris
from the brushroll.

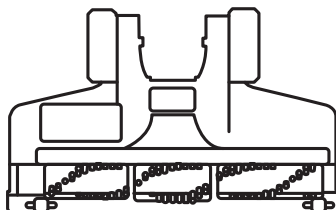

HOW TO

STORE YOUR UNIT:

Keep your vacuum and tools
together in the storage bag.

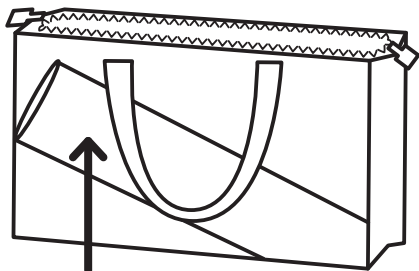

Extension or powered
wand pocket

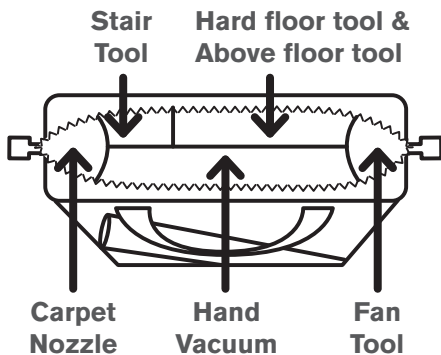

TROUBLESHOOTING

Any other servicing should be done by a Dirt Devil authorised service agent. If appliance is not working as it should, has been dropped, damaged, left outdoors, or dropped into water, take it to an authorised service agent prior to continuing use. For your nearest service centre please call AU: 1300 361 505 / NZ: 0800 800 900



WARNING

To reduce the risk of personal injury - Unplug before cleaning or servicing.

PROBLEM	POSSIBLE CAUSE	POSSIBLE SOLUTION
Vacuum won't run	1. Power cord not firmly plugged into outlet.	1. Plug unit in firmly.
	2. Blown fuse or tripped breaker.	2. Check fuse or breaker in home. Replace fuse/reset breaker in home.
	3. No voltage in wall plug.	3. Check fuse or breaker in home. Replace fuse/reset breaker in home.
	4. Thermal Protector activated.	4. Unplug and allow vacuum to cool for 30 min. (This will reset the thermal protector)
Dust escaping from vacuum	1. Dirt cup full.	1. Empty dirt cup.
	2. Dirt cup not installed correctly.	2. Review Dirt Cup removal & replacement.
	3. Filter not installed correctly.	3. Review Filter Removal and Cleaning.
Smoky/burning smell detected	1. Belt broken or stretched.	1. Call us on AU: 1300 361 505 / NZ: 0800 800 900
	2. Brushroll is clogged.	2. Clear/remove debris from brushroll.
Vacuum tools won't pick-up	1. Dirt cup full.	1. Empty dirt cup.
	2. One or both filters are clogged.	2. Remove both filters and clean.
	3. Stair + upholstery tool not spinning.	3. Review tool section.
	4. Power carpet nozzle not spinning.	4. Review tool section.
Poor suction	1. Dirt cup not seated completely.	1. Reinstall dirt cup make sure lid is closed completely.
	2. One or both filters clogged.	2. Remove both filters and clean.

TECHNICAL SPECIFICATIONS

Model no.:	DD360
Wattage:	600W
Voltage:	220-240V ~ 50Hz
Filters:	Pre-motor: Foam, Rinsable Post-motor: Foam, Rinsable
Weight (cylinder):	2kg
Cord length:	6m

Subject to technical change without notice.



Double Insulated



This product meets applicable regulatory requirements



Indoor Use



Read Instructions



Distributed by Techtronic Industries Australia Pty. Ltd.

31 Gilby Road, Mt Waverley

Victoria, 3149, Australia

www.dirtdevil.com.au

Service Line:

AU: 1300 361 505 / NZ: 0800 800 900

LET'S GO.