

# Platinum Concertina Door

## INSTALLATION INSTRUCTIONS

### DIMENSIONS

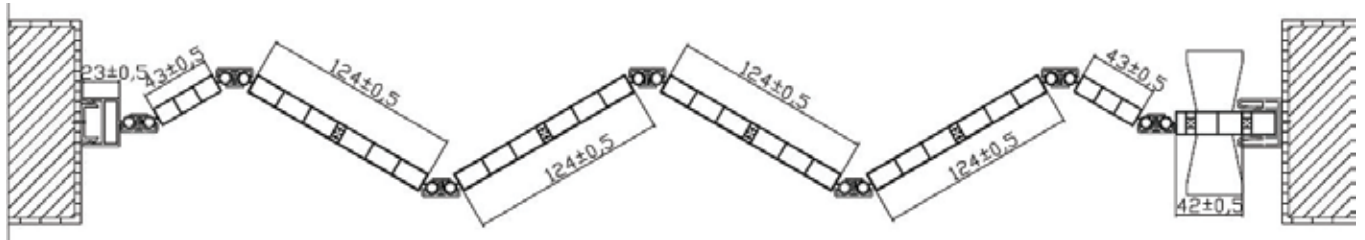

### COMPONENTS

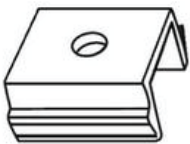

Fasteners x 5

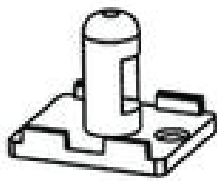

Lock Pin x 1



Screw A x 15  
(Headrail - Fasteners - Pin)

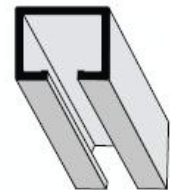

Headrail/Top Track x 1



Handle Set x 1

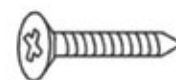

Closure Channel x 1

Screw B x 2  
(Handle)

**STEP 1.**

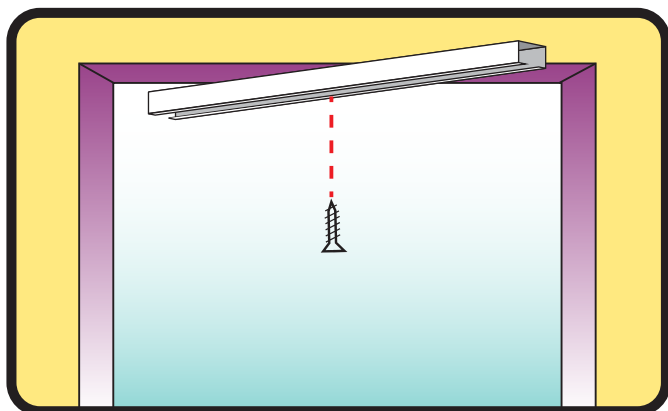

Centre Top Track in doorway and secure with a single screw (A) in the centre to allow track to pivot/turn.

**STEP 2.**

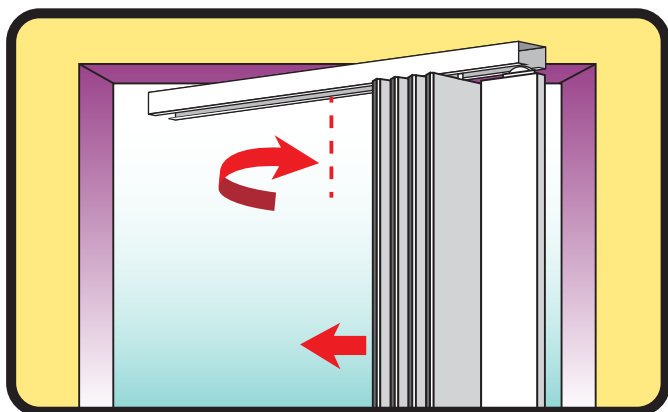

Pivot Top Track out from frame to enable the door panels to slide onto track. Align panel top rollers with track channel and insert into top track.

**STEP 3.**

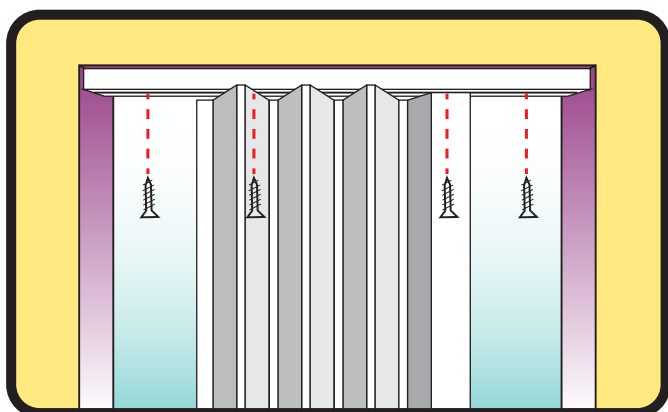

Re-align Top Track with doorway/frame and secure firmly into place with additional screws (A).

**STEP 4.**

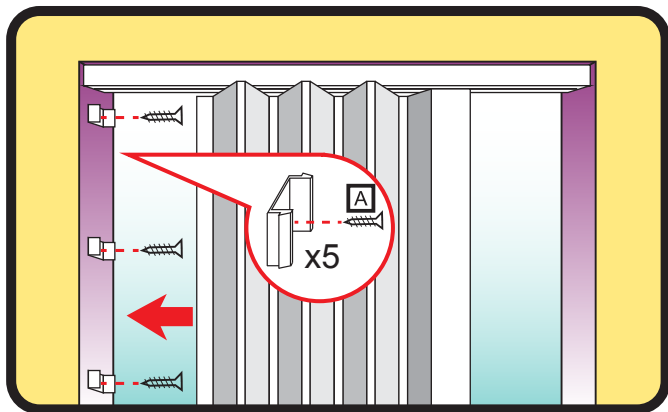

Align and attach side fasteners to wall or frame at equal spacings using screws (A).

**STEP 5.**

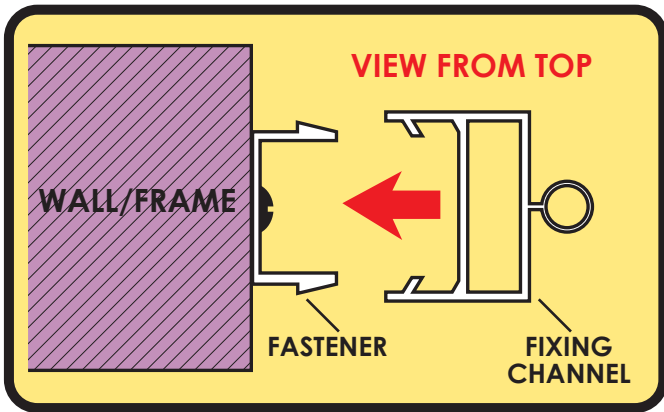

Firmly press the Fixing Channel onto Fasteners until locked into place

**STEP 6.**

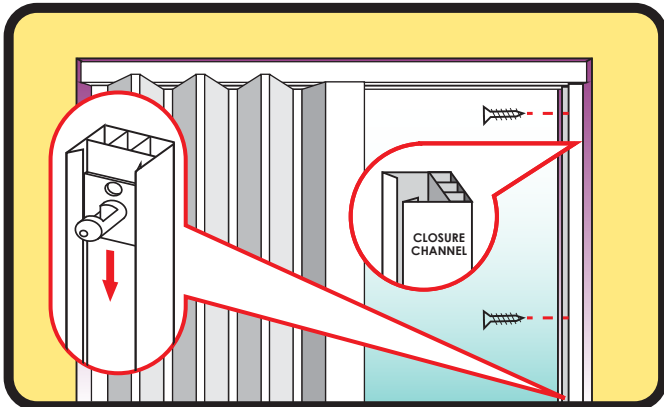

Insert locking pin into Closure Channel and align with door on opposite side. Secure using screws provided (A).

**STEP 7.**

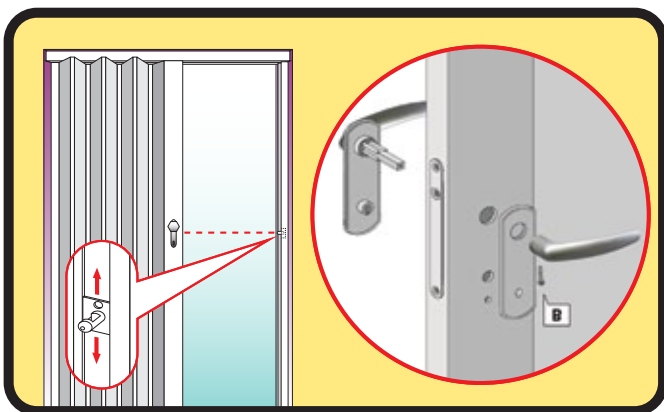

Install Handle onto door as shown using Screws (B).

Align Locking Pin with Locking Mechanism and fix into place using Screws (A)

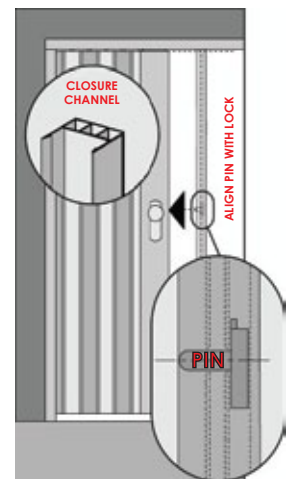

**STEP 8.**

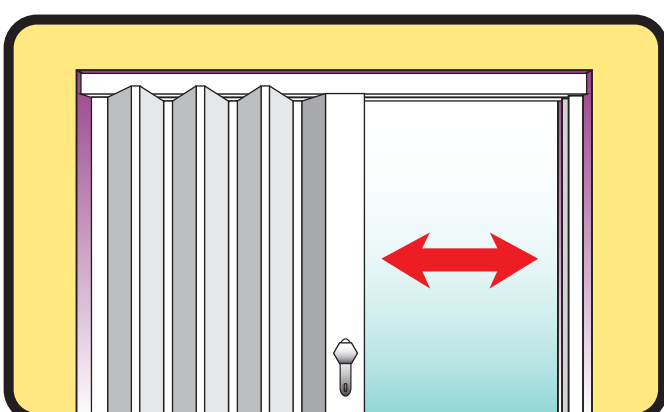

Your Platinum Concertina Door is now ready to use.

Don't apply vertical force greater than 10kgs to the door as damage can occur.

Panels can be dented or damaged by excessive lateral force. Do not lean items against door.