



we  clean

User Guide

Vax Service line AU: 1300 361 505

NZ: 0800 800 900

Handheld

GATOR

10.8V

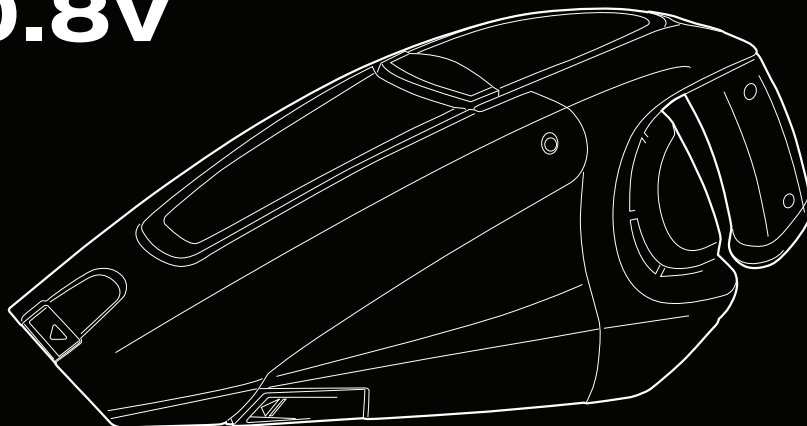

Get Cleaning...

What's your Vax's model number?

V G H 1 0 8 V

What's your serial number? (Located on the base of the machine)

■ - ■ ■ ■ ■ ■ ■ - ■ ■ - ■ ■ - ■ ■ - ■ ■ ■ ■ ■ ■ ■ ■

Note these down in case you need them in future. Please keep instructions for further use.

www.vax.com.au

VGH108V

Machine Overview

- 1 Retractable crevice tool
- 2 Dirt container release buttons
- 3 Handle
- 4 On/off switch
- 5 Charging indicator (red LED)
- 6 Dirt container removal button (access to filters)
- 7 Dirt container
- 8 Filter
- 9 Charger

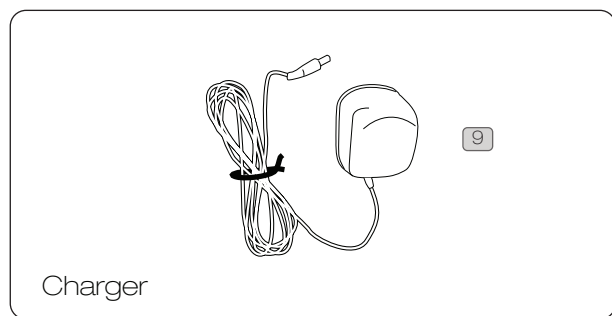
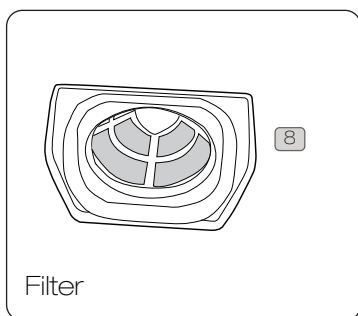
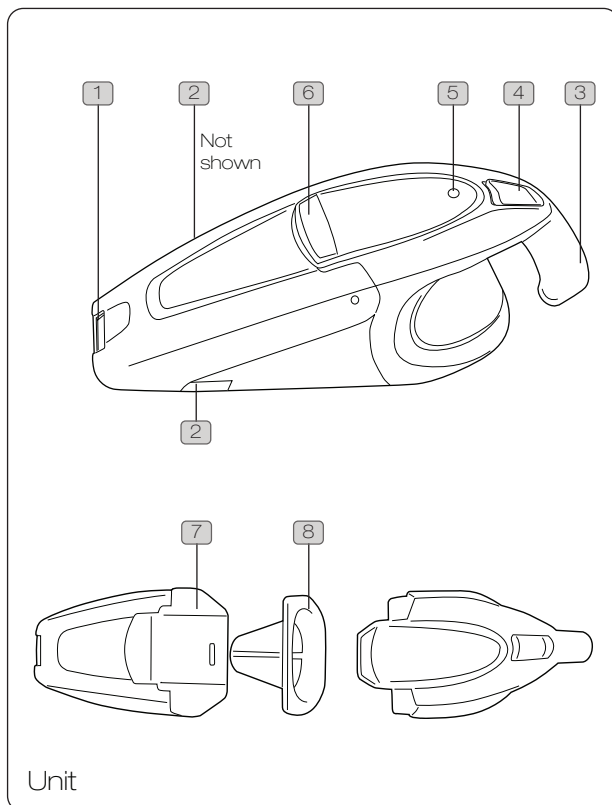

General Safety Information

FOR HOUSEHOLD USE ONLY.

When using the handheld, basic safety precautions should always be observed, including the following:

 **WARNING:** Do not use outdoors or on wet surfaces.

1. Do not charge the unit outdoors.
2. Turn off the handheld before connecting or disconnecting from the mains supply.
3. Children should be supervised to ensure that they do not play with the appliance.
4. This appliance is not intended for use by persons (including children) with reduced physical, sensory or mental capabilities, or lack of experience and knowledge, unless they have been given supervision or instruction concerning use of the appliance by person responsible for their safety.
5. Use only as described in this manual. Use only the manufacturer's recommended attachments.
6. Do not use with damaged cord or plug. If the appliance is not working, as it should, has been dropped, damaged, left outdoors, or dropped into water, return it to a Vax Authorised Service Agent or suitably qualified person for examination, repair or adjustment.
7. Do not abuse the cord. Keep the cord away from heated surface. Do not pull the cord around sharp edges or corners. Do not close the cord in a door.
8. Do not handle the plug or appliance with wet hands.
9. This product contains rechargeable Nickel Cadmium batteries. Do not throw batteries into fire or expose them to high temperatures, as they may burst.
10. Do not use with any opening blocked; keep free of dust, lint, hair, and anything that may reduce airflow.
11. Keep hair, loose clothing, fingers and all parts of the body away from openings and moving parts.
12. Do not pick up hot coals, cigarette butts, matches or anything hot, smoking or burning objects.
13. Do not pick up flammable or combustible materials (lighter fluid, petrol, kerosene, etc) or use in the presence of explosive liquids or vapour.
14. Do not vacuum up harmful or toxic material (chlorine bleach, ammonia, drain cleaner, etc).

15. Do not use without the filter in place.
16. Do not vacuum up hard or sharp objects such as glass, nails, screws, coins, etc.
17. Turn off all controls before unplugging.
18. Take extra care when cleaning on stairs
19. Store the appliance indoors in a cool, dry area.
20. Use only the charger supplied by the manufacturer to recharge.

 **IMPORTANT:** For dry debris use only.

 **WARNING:** Always switch off and unplug the handheld from the electrical outlet before assembling, opening or emptying the dirt container, or before connecting/disconnecting the attachments or performing any maintenance.

 **IMPORTANT:** Remove the battery from the appliance before recycling. For further information please contact your local waste management centre.

This handheld is intended for household use only and NOT for commercial or industrial use.

PLEASE KEEP INSTRUCTIONS FOR FURTHER USE.

Operation

Charging

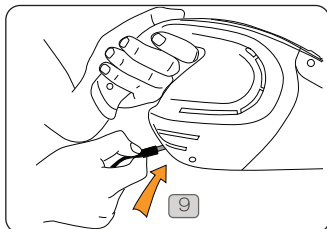

Plug charger into the mains and insert lead into back of unit.

NOTE: The initial charging time is 24 hours.

Operating the appliance

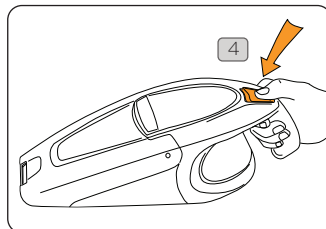

On/off switch

○ off
| on

Tools

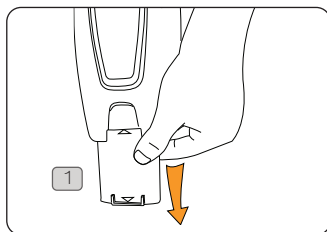

Crevice tool is retractable.

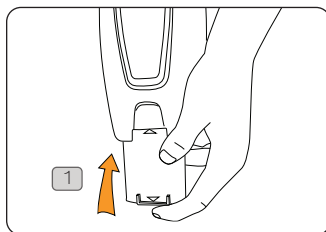

Emptying the dirt container

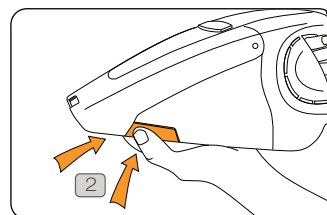

To open, press both buttons either side of the dirt container simultaneously.

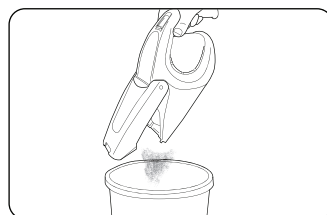
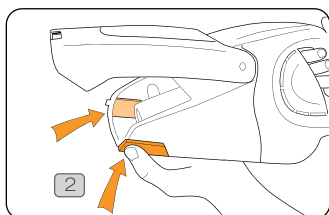

Empty over a bin.

Maintenance (Keep your Vax as good as new)

Dirt container and filter maintenance

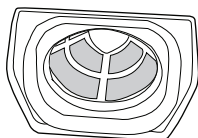

8

! **IMPORTANT:** The condition of the filter affects the performance of your machine. Please check and clean the filter periodically (depending on the level of use).

! **IMPORTANT:** Do not use the handheld without the filter in place.

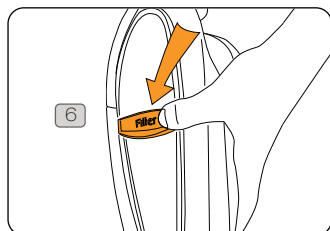

6

Depress the dirt container removal button and pull nozzle away from unit.

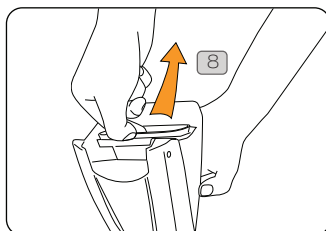

8

Hold nozzle over a bin. Grasp filter gently and pull out.

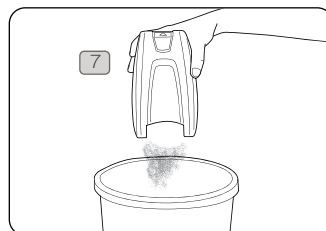

7

Shake excess dirt from dirt container. Tap against bin for better result.

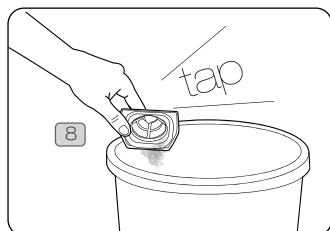

8

Tap filter against bin.

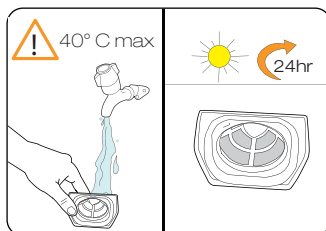

! 40° C max

24hr



8

Return filter to dirt container.

To re-attach dirt container

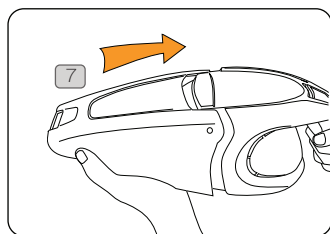

7

Align bottom of the dirt container first and clip nozzle on.

FAQs



WARNING: to reduce the risk of personal injury, unplug the handheld before performing maintenance/troubleshooting checks.

Why will the handheld not run?

- The battery may not be charged. To charge the battery, the power switch must be in the 'OFF' position. The red light shows the unit is charging. The initial charge should be for 24 hours.
- For further assistance, please call us on: **AU: 1300 361 505 / NZ: 0800 800 900**

Why won't the handheld pick up?

- The nozzle or crevice tool may be blocked, remove the obstruction.
- The filter may be clogged or dirty, clean the filter. Refer to the Maintenance section (Page 5).
- The battery charge is getting weak, let the battery run until it slows and recharge.
- The dirt container is full, empty the container.
- For further assistance, please call us on: **AU: 1300 361 505 / NZ: 0800 800 900**

Why won't the battery recharge?

- Check the vacuum is switched off.
- The charger may not be inserted correctly.
- Check the mains power is switched on.
- The electrical outlet may not be working: check the fuse or breaker and consult an electrician.
- For further assistance, please call us on: **AU: 1300 361 505 / NZ: 0800 800 900**



we  to help

Don't take your machine
back to the shop, simply
contact us

www.vax.com.au

AU: 1300 361 505
NZ: 0800 800 900

This does not affect your statutory rights.

Other Information

Service & Help

Vax Customer Careline AU: 1300 361 505 / NZ: 0800 800 900

Monday-Friday 8.30am to 5.30pm

Any queries or concerns about using the Vax, call the Vax Careline. Please make a note of the serial number and model number of the carpet cleaner before calling. For the nearest Service Agent, please call the Vax Customer Careline or visit www.vax.com.au

Technical Specification

Battery voltage:	10.8V
Capacity:	0.2L
Runtime:	6 mins
Weight:	1.24kg
Charger input voltage:	230 - 240V - 50Hz
Initial Charge time:	24 hours
Filter type:	Washable

Subject to technical change without notice.



N197



Waste electrical products should not be disposed of with household waste. Please recycle where facilities exist. Check with your Local Authority or retailer for recycling advice.



we  clean

Distributed by Techtronic Industries Pty. Ltd.
Level 1, 666 Doncaster Rd, Doncaster, Australia 3108.
www.vax.com.au. Service Line: AU: 1300 361 505 / NZ: 0800 800 900