



# BBQ RANGEHOOD

Model No. GR1000



- Stainless steel finish
- 1200mm wide, suits most 4 and 6 burner BBQ's
- Maximum 2000m<sup>3</sup> air flow
- LED lights at front and rear of the rangehood
- Stainless steel baffle filters
- For outdoor use only

---

**Important: Retain these instructions for future use.**

---

## WARRANTY TERMS & CONDITIONS

This warranty is not transferable to a subsequent purchaser if the product is sold by the original purchaser during the warranty period.

If a warranty fault appears within the warranty period, S.G.A. reserves the right to replace or repair the product.

In the event that S.G.A. chooses to replace the product, this original warranty will expire at the original date.

If the product includes various accessories or components, only the defective accessory or component will be replaced or repaired.

S.G.A. Reserves the right to replace defective parts of the product with parts and components of similar quality, grade and composition where an identical part or component is not available.

Products presented for repair may be replaced by refurbished products of the same type rather than being repaired. Refurbished parts may be used to repair the products.

To make a warranty claim, first contact S.G.A.'s Customer Service Line on the contact number below.

The purchase receipt for this product is to be retained and must be presented if making claim under the terms of this S.G.A. warranty.

Warranty repairs are free of charge, provided the product is delivered to our Service Department at 33-35 Lionel Road, Mt Waverley, Victoria, 3149 or to one of our Authorised Service Agents.

If a warranty fault is found the freight cost will be credited to the owner. If no fault is found the product will be returned and any costs associated with the service will be charged to the owner.

Products sent freight forward will not be accepted. In most cases the defective accessory or component only will need to be returned. The product or part of the product being returned must be adequately protected in a box.

S.G.A. will not be responsible for any in-transit loss or damage.

This warranty does not apply to any defect, deterioration, loss, injury or damage occasioned by or as a result of misuse or abuse, negligent handling or storage, normal wear and tear or if the product has not been installed and used in accordance with S.G.A.'s instructions, recommendations and specifications or if the product has been subjected to abnormal conditions. The warranty does not apply to blockages caused by insects or living organisms, as well as non-operating butterfly baffles or incorrectly installed ducts.

The warranty is void if there is evidence of the product being tampered with by unauthorised persons. The warranty does not extend to installation or disconnection costs.

Our goods come with guarantees that cannot be excluded under the Australian Consumer Law. You are entitled to a replacement or refund for a major failure and for compensation for any other reasonably foreseeable loss or damage. You are also entitled to have the goods repaired or replaced if the goods fail to be of acceptable quality and the failure does not amount to a major failure. The benefits of this warranty are in addition to any rights and remedies imposed by Australian State and Federal legislation that cannot be excluded.

### Product Approved For Outdoor Use Only

For warranty claims, service, spare parts or products information in Australia, please call SITRO GROUP AUSTRALIA Pty Ltd on the Customer Service Line 1300 174 876.

A receipt or proof of purchase is required and must be kept for your records.

### CONTACT DETAILS

Sitro Group Australia Pty Ltd  
33-35 Lionel Road, Mt. Waverley  
Victoria 3149, Australia  
Tel (+613) 9543 9533  
Fax (+613) 9543 9839  
service.group@sitro.com.au

**For any queries or assistance call**



**Customer Service  
Australia Only**

**1300 174 876**

Hours of operation:

Monday to Friday 8am - 5pm EST

**Do not return to place of purchase.**

## INSTALLATION - OUTDOOR USE ONLY

Read all instructions before installing and operating this Rangehood.

This Rangehood is designed for use above an outdoor domestic gas (propane/natural) barbecue.

### WHAT IS AN OUTDOOR AREA

An outdoor area is an open-air situation that is not obstructed by buildings, structures etc, facilitating correct combustion and allowing products of combustion to be readily dispersed to atmosphere.

An alfresco area, veranda or balcony (large area) is considered outdoors when it is an open-air situation with natural ventilation. This ensures stagnant areas do not form, as these prevent the products of combustion from being rapidly dispersed by wind and natural convection. In the unlikely event of a gas leak occurring, a well-ventilated area will allow escaping gases to rapidly disperse.

The following situations are considered to provide the natural ventilation required for an outdoor domestic barbecue or patio heater to be used:

- Four open sides with a roof or overhead cover.
- Four enclosed sides (walls) without a roof or overhead cover.
- Two parallel walls or two walls at right angles to each other with a roof or overhead cover.
- Three walls, with the one open side being at least 25 per cent of the total perimeter and the remaining three walls having an area of 30 per cent or more of unrestricted opening, with a roof or overhead cover.

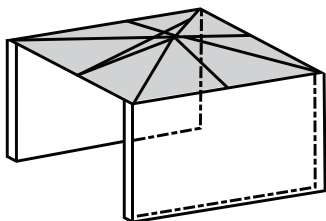

Parallel Walls

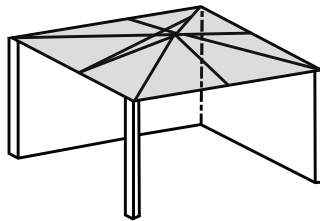

Right Angle Walls

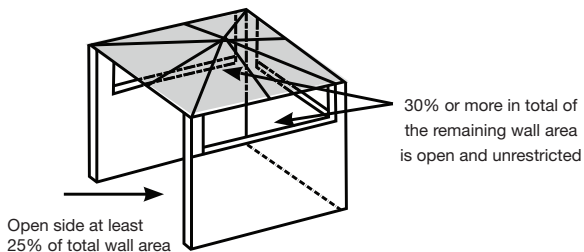

### Electrical Data IMPORTANT SAFETY RULES

This rangehood is fitted with a sealed electrical connection plug that is compatible with the mains power supply for Australia / New Zealand and meets the requirements of Australian Standards. This rangehood must be connected to a supply voltage that is equal to that stated on the rating label. If the mains power connection plug or power cord becomes damaged it must be replaced with a complete assembly that is identical to the original, and this must be replaced by an authorised service centre. Always follow the Australian / New Zealand requirements for connection to the mains supply. If in doubt always consult a qualified electrician.

# INSTALLATION - OUTDOOR USE ONLY

## BALCONIES & VERANDAS

An outdoor barbecue or rangehood may be installed and used on a balcony or veranda if, by location and use, it will not cause a hazard and the manufacturer's instructions allow for such use. It may also be necessary to consult local building laws before installing or using a gas barbecue on a balcony or veranda.

A balcony or veranda shallow in depth and with a roof and three enclosed sides is considered an acceptable area if the following applies:

- the depth of the balcony or veranda is smaller than or equal to its height; and
- the open face width is at least twice the depth.

Examples of these situations:

- A balcony with an open construction balustrade (more than 75 per cent free open area). Measure the distance from floor to roof 'H'.
- The maximum allowable depth 'D' is the same as 'H' and the minimum width 'W' is twice 'D'.
- A balustrade is enclosed or has less than 75 per cent free open area. Measure from the top of the balustrade to the roof 'Ha'. The maximum allowable depth 'D' is the same as 'Ha' and the minimum width 'W' is twice 'D'.

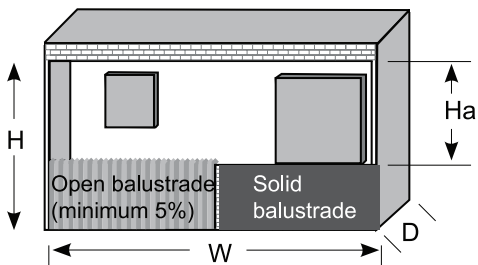

### IMPORTANT

It is recommended that access doors or windows to the balcony or veranda be closed while the barbecue is in use. If unsure always consult with your local building authority and local gas authority.

## IMPORTANT SAFETY NOTICE

- Disconnect the power supply when changing light bulbs.
- This appliance is not intended for use by persons (including children) with reduced physical, sensory or mental capacities, or lack of experience and knowledge, unless they have been given supervision or instruction concerning use of the appliance by a person responsible for their safety.
- Young children should be supervised to ensure that they do not play with the appliance.
- There shall be adequate ventilation of the room when the Rangehood is used at the same time as appliances burning gas or other fuels.
- There is a fire risk if cleaning is not carried out in accordance with the instructions. You must read the details the details concerning the method and frequency of cleaning.
- Do not flambé under the Rangehood.
- Exhaust air must not be discharge into an existing flue which is used for exhausting fumes from appliances burning gas or other fuels.
- The minimum distance between the hob surface and the lowest part of the Rangehood is 1200mm. This distance shall be at least 1200mm, if the Rangehood is installed over a barbecue. If the instructions for the barbecue specify a greater distance, this has to be taken into account.
- Attention should be given to ensure that any applicable regulations concerning the discharge of exhaust air is fulfilled.
- Note that accessible parts may become hot when used with cooking appliances.

- Remove any plastic coating from the product before use.
- Do not attempt to modify this appliance as this could cause injury and will void your warranty.
- Underside surfaces can become hot during use. Do not touch.
- Never leave barbecue unattended during use as fat fires and flare ups may occur.
- Always operate the product from a power source of the same Voltage, Frequency and Rating as indicated on the Product Identification Plate.
- Avoid leaving Rangehood operating when unattended.
- Avoid contact with moving parts. Keep hands, hair and clothing, well away from the product while it is in operation.
- Do not remove filters whilst Rangehood is operating.
- The appliance is fitted with removable filters. Ensure the filters are removed and thoroughly cleaned at least once every two months or every 30 hours in accordance with these instructions.
- There is a fire risk if cleaning is not carried out in accordance with the instructions.
- Do not use the product for other than its intended use as described in these instructions. This product is intended for Normal Domestic Household Use only.
- The power supply must be supplied through a residual current device (RCD) having a tripping current not exceeding 30mA.
- Incorrect installation is not covered under warranty.

## PRIOR INSTALLATION - IMPORTANT NOTICE

Please read the entire instruction manual before installing the Rangehood.

The installation in this manual is intended for qualified installers, service technicians or persons with similar qualified backgrounds. DO NOT attempt to install this appliance yourself. Injury could result from installing the unit due to lack of appropriate electrical and technical background.

Always ensure this Rangehood is installed as per the requirements noted in AS/NZS 3000:2007.

There shall be adequate ventilation of the room when the Rangehood is used at the same time as appliances burning gas or other fuels (not applicable to appliances that only discharge the air back in to the room).

If the supply cord of this equipment is damaged, it must only be replaced by the manufacturer or its service agent or a similarly qualified person in order to avoid a hazard.

Always switch power off prior to installation.

All electrical work must be done in accordance with local and national electrical codes as applicable and installed by a licenced electrician.

For safety, this product must be earthed.

A power outlet should be within 1000mm of the power cord exit from the Rangehood.

The socket must be accessible and enable the end user to isolate the Rangehood from the power for the purpose of internal cleaning or maintenance.

Stainless steel or powder coat is very easily damaged during installation if abraded or knocked by tools. Protect the Rangehood with the cardboard box or plastic bag during installation.

All ducting must comply with local requirements, building codes and gas codes.

It is not recommended to use old duct work. It should be replaced if necessary to avoid the possibility of a grease fire. Check all joints on duct work to ensure proper connection all joints should be properly taped.

The Rangehood is designed for indoor undercover use only and must be in a dry location.

Suitable fixings will be required to mount this Rangehood. These are not included.

Note that accessible parts may become hot when used with cooking appliances.

The power supply must be supplied through a residual current device (RCD) having a tripping current not exceeding 30mA.

**Incorrect installation is not covered under warranty.**

### CONTENTS

- 1 x Rangehood with 2 x 150mm duct adaptors fitted
- 2 x Chimney covers each 400mm high
- 1 x Chimney mounting bracket top
- 2 x Expanding ducts 150mm x 2m

### REQUIRED FOR USE

Accessible power pointed fitted within 1m of Rangehood mounting position. The power point must be supplied through a residual current device (RCD) having a tripping current not exceeding 30mA.

### TYPICAL EQUIPMENT REQUIRED FOR INSTALLATION

- Electric drill
- Suitable mounting hardware
- Drills
- Screwdriver
- Tape measure/rule
- Plumb bob
- Spirit level
- Ladder

For ducting:

- Duct tape
- Jigsaw
- Duct elbows as required for correct installation
- Roof cap or duct exit as required for correct installation

# RANGEHOOD INSTALLATION

## BEFORE INSTALLING

Please consider the following before commencing to install your rangehood.

Your rangehood will need to be ducted to ensure it operates and complies with local and national regulations.

## DUCT MOUNTING OPTIONS

You will need some additional parts to complete these installations.

All motors need to be ducted individually and the included expanding duct is 150mm diameter.

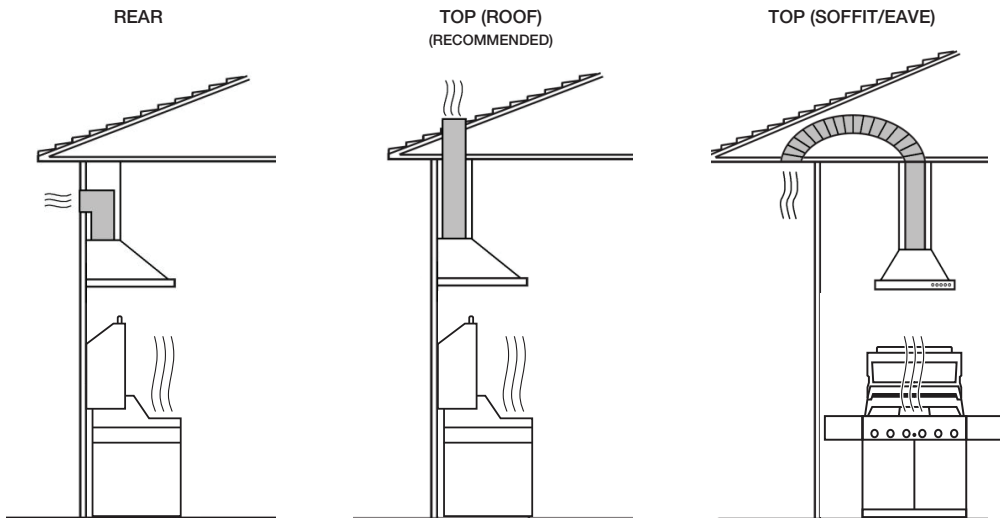

\*If installing ducting at the Rear or via the Soffit/Eave please review page 9 for the reductions in ducting requirements.

# RANGEHOOD INSTALLATION

The ideal position of the Rangehood is as follows:

1. Height above cooking surface – 1200mm
2. Distance from cooking surface to Rangehood mounting bracket bottom screw hole:
  - Bottom mounting holes - 1260mm
  - Top mounting holes – 1635mm

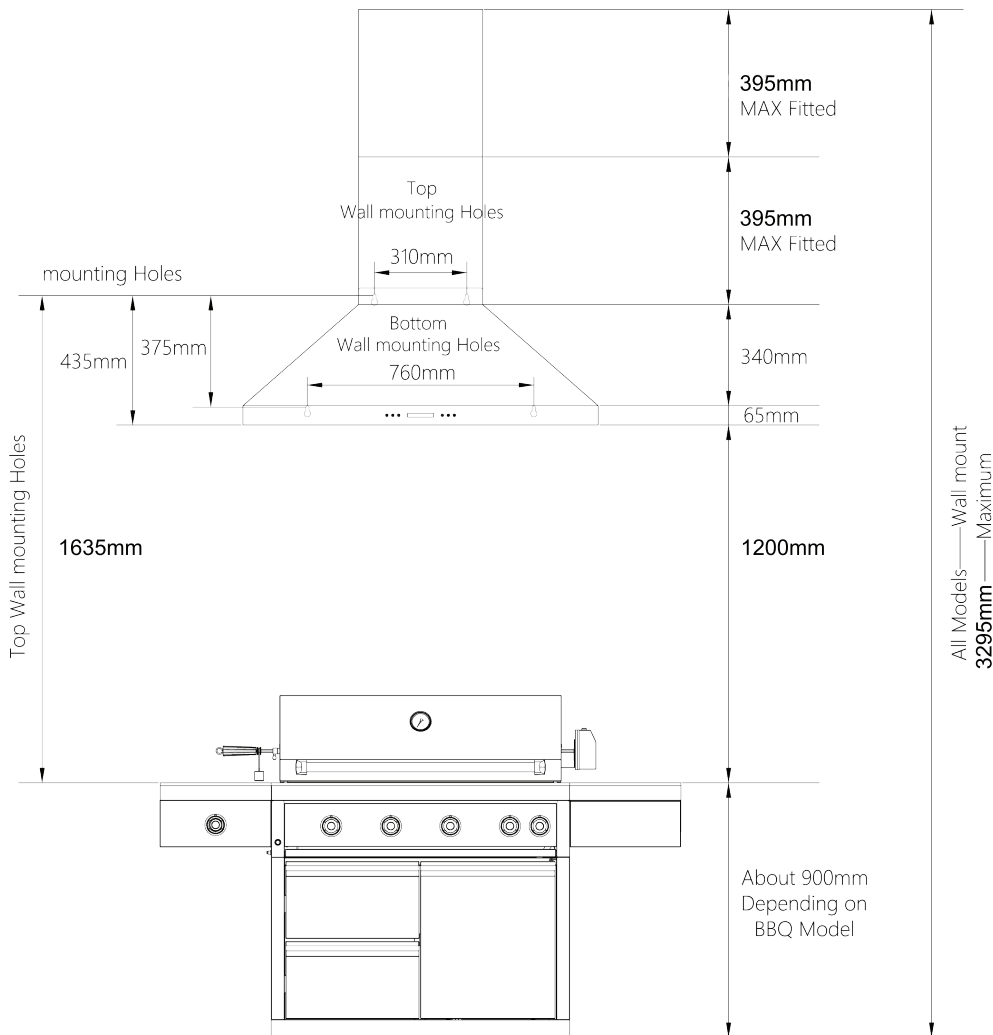



## DUCTING

All motors need to be ducted individually to ensure air flow and suction is adequate and meets all regulations.

GR1000 Medium – 2 Ducts 150mm Ø

If installation of ducts is not straight up vertically please use the following as a guide and we recommend speaking with or engaging a licenced installer.

### DUCT RUN CALCULATIONS

Maximum allowable duct run per motor:

150mm Ducting	30m
Deduct the following from the maximum ducting	
Minus per 90° elbow used	5m
Minus per 45° elbow used	3m
Minus per duct size transition	1m
Minus side wall cap/eave damper	10m
Minus roof cap	10m

For example: 1 x roof cap, 1 x 90° elbow, 1 x 45° elbow, 1 x duct transition – actually used.

This means the actual length of 150mm ducting to be used is a maximum of:

30m Duct run minus (-) (10m + 5m + 3m + 1m) = 11m actual ducting can be used.

Flexible ducts are provided for convenience, always use rigid type metal ducts if available to maximize air flow.

Also use calculation (above) to compute total available duct run when using elbows, transitions and caps.

ALWAYS, when possible, reduce the number of transitions and turns. If a long duct run is required, increase duct size from 150mm to 200mm.

If a reducer is used, install a long reducer instead of a pancake reducer. Reduce duct size as far away from motor as possible.

If turns and transitions are required; install as far away from motor and as far apart between the two as possible.



### WARNING - FIRE

NEVER Exhaust air or terminate duct work into spaces between walls, crawl spaces, ceilings, attics or garages. All exhaust must be ducted to the atmosphere.

Use Metal duct work only.

Fasten all connections with sheet metal screws and tape all joints with certified Silver tape or duct tape.

Although this rangehood is supplied with flexible expanding duct it is highly recommended that you use rigid metal ducting. This will improve airflow.

## INSTALLING - WALL MOUNT RANGEHOODS

Mounting bracket is attached and part of the medium rangehood motor cover.

Note: Rangehood must be level, if not rangehood will not operate correctly.

1. Using a tape measure mark the top mounting holes, refer below, above cooking surface. This line should be level.
2. Using a tape measure mark the bottom mounting holes, refer below, down from the line discussed in item 1. This line should be level.
3. Find the centre of the BBQ cooking surface and using a plumb bob, mark this centre on the above lines discussed in Item 1 & 2.
4. Mark the top mounting holes on the line discussed in Item 1. These marks should be either side of the centre mark discussed in Item 3, refer below.

5. Mark the bottom mounting holes on the line discussed in Item 2. These marks should be either side of the centre mark discussed in Item 3, refer below.
6. Your rangehood is very heavy. Please use suitable fixings and hole size for this weight.  
Medium – 42Kg
7. If unsure of which fixings please discuss with your hardware stockist or rangehood installer.
8. Using two people, lift rangehood into place and secure to the wall using selected hardware. Ensure rangehood is level.

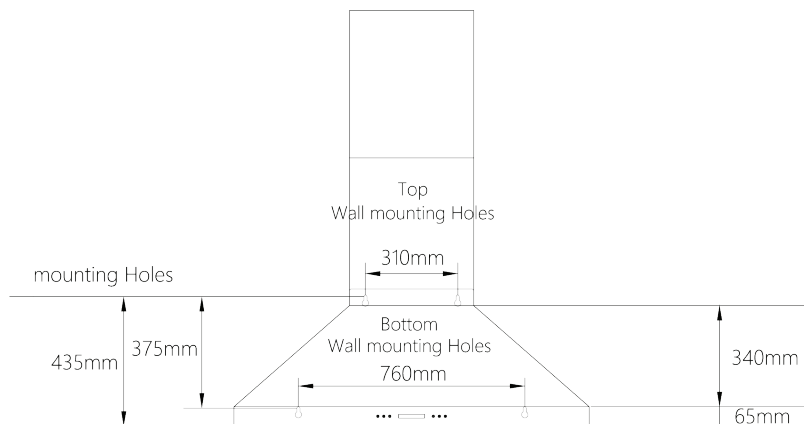

# INSTALLING - WALL MOUNT RANGEHOOD

## DUCTING

1. Remove all tape from the ducts butterfly flaps and ensure they move up and down freely.
2. Position the butterfly flaps up.
3. Position the ducting over the top of the collection box and butterfly flaps. Note: If unsure about the ducting please contact a rangehood installer.
4. If using a rangehood installer or roof plumber duct through ceiling and roof in accordance with the local, state and national regulations and laws.

## POWER

Using a plumb bob or spirit level determine the vertical line the flue surrounds will take.

The position of the 240V AC wall socket is that it must be accessible to turn on/off without removing any covers.

Note: All electrical work must be carried out by a licensed electrician.

1. Uncoil power cord.
2. Plug into wall socket and turn on.
3. Test the fans and lights as per "Using Rangehood".
4. If all okay turn off wall socket and unplug power lead.

## FLUE SURROUND

Provided are 2 x flue surrounds both 400mm high. These are used to finish and cover the motor box and installed ducting.

1. Lift and fit bottom flue surround, this fits into the groove in the Rangehood flat top.
2. Mark 1 hole on each side for the flue surround. Remove flue surround and drill holes.
3. Replace flue surround and secure each side at the top with suitable screws.
4. Mounting the second flue surround, this goes on the inside of the one previously installed.
5. Using a spirit level, plumb bob and tape measure position the flue bracket as high as possible. Once in correct position mark holes and drill.
6. Secure the flue bracket with suitable screws.
7. Slide the second flue cover inside the first. Make sure the power cord is clear of the flue surround. Now fasten to the flue bracket, make sure not to damage power cord.
8. Push 240V AC plug into power socket and turn on.

Note: Do not damage the power cord during the flue surround installation.

## CLEANING

A build up of oil may occur if the Rangehood and baffle filters are not cleaned properly and regularly. Some discolouration of the baffle filter may occur if cleaned in the dishwasher.

### RANGEHOOD SURFACES

Clean periodically with hot soapy water and a clean cotton cloth. Do not use abrasive detergent or steel wool/scouring pads which will scratch and damage the surfaces.

For heavier deposits, use a liquid degreaser.

After cleaning, you may use nonabrasive stainless steel polish/cleaners to polish and buff the stainless lustre. Always rub lightly, with a clean cotton cloth and with the grain of the stainless steel.

Note: Never wipe or rub across the grain as this will damage the surface finish.

### BAFFLE FILTERS

The baffle filters fitted by the factory are intended to filter out residue and grease from cooking. They are required to be kept clean and should be cleaned after every 30 hours of use or more often if required or after heavy cooking.

Note: Always turn the Rangehood power point off before removing filters.

#### To Remove

Lift latch and gently pull down front of baffle filter and remove.

#### To Clean

1. Use warm soapy water and a soft cloth or put into dishwasher on a 'normal' cycle.
2. Thoroughly clean and wipe down the inside of Rangehood canopy.

#### To Fit

1. Position the rear of the baffle filter into the 2 slots.
2. Gently rotate the baffle filter into position, lift latch and push into place and release latch.



**Read all instructions before installing and operating this appliance.**

### IMPORTANT SAFETY NOTICE

Read all instructions in this manual before operating the appliance. Save these instructions for future reference.

Always leave safety grills and filter in place. Without these components, operating blowers could catch on to hair, fingers and loose clothing.

NEVER dispose cigarette ashes, ignitable substances or any foreign objects in to the blowers.

NEVER leave cooking area unattended. When frying, oil in the pan can easily overheat and catch fire. The risk of self-combustion is higher when the oil has been used several times.

## OPERATION

Press the  to turn on the rangehood. The display backlight will come on and the power icon will be displayed.

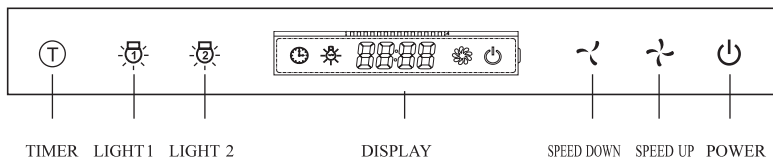

### CONTROL PANEL

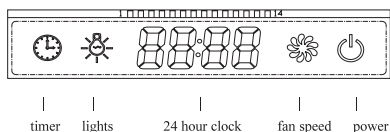

### DISPLAY PANEL





### CLOCK

1. Each time the rangehood is reconnected to a power supply, the control panel will beep once. The clock will reset and show 12:00. The rangehood will be in standby mode without lights or motors operating. The control panel will not be backlit.
2. To set the time. In standby mode, press the  button. The hour indicator will flash. Adjust the hour by using the  or  buttons. Press the button once to change by one minute, or hold the button in for continuous adjustment.



If the  button is not pressed for 10 seconds, the display will go back to standby mode.

### FAN



3. The fan speed cycles between OFF-LOW-HIGH-BOOST-OFF with each press of the  button.
4. The fan speed cycles between OFF-BOOST-HIGH-LOW-OFF with each press of the  button.

5. The fan icon will appear in the display whenever the fan is running. The fan icon will rotate to indicate the fan speed.

### LIGHTS

6. The  button turns the centre two lights on and off. The  button turns the four front lights on and off.

### TIMER BUTTON

6. To activate the 3 minute delayed shutdown. With the fans running, press the  button. The fans will switch to LOW, the display will show 3.00 minutes, count down to zero, then switch off the fans. To cancel the delayed shut down, press the  button.

# SPECIFICATIONS

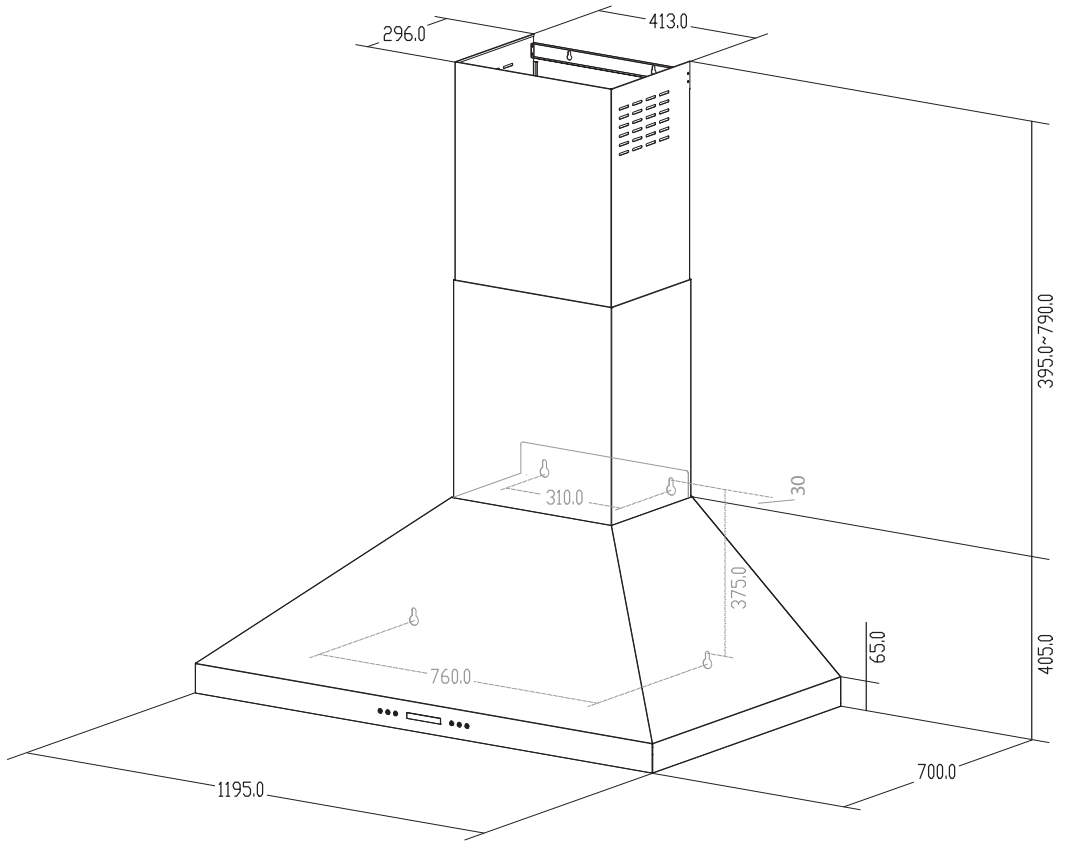

Description	<b>GR1000</b>
Finish	Marine grade stainless steel #304
Size (mm)	1200 W x 700 D
Total Height	445mm - Not including flue covers
Height Above Cooking Surface	1200mm - Minimum      1250mm - Maximum
Air Volume, Gross	2000m <sup>3</sup>
Noise	≤ 80db
Motors - Electric induction	2
Lighting - Cool white	4 x Rectangle 18 LED
Controls	1 x Push button
Flues - Always duct individually	2
Duct Diameter	150mm
Flue Surround	2 at 400mm high
Filters	Stainless steel #304 baffle style
Ducts - Flexible Expandable Metal	2 - Total expanded length 2m each
Weight	42Kg



**For any queries or assistance call**



**Customer Service**  
(Australia Only)

**1300 174 876**

Hours of operation:  
Monday to Friday 8am - 5pm EST

**Do not return to place of purchase.**  
Keep your purchase receipt, this will be required to  
make any claims under the 12 month warranty.