

PE312

Petite

Oliveri®

RIGHT HAND BOWL SINK

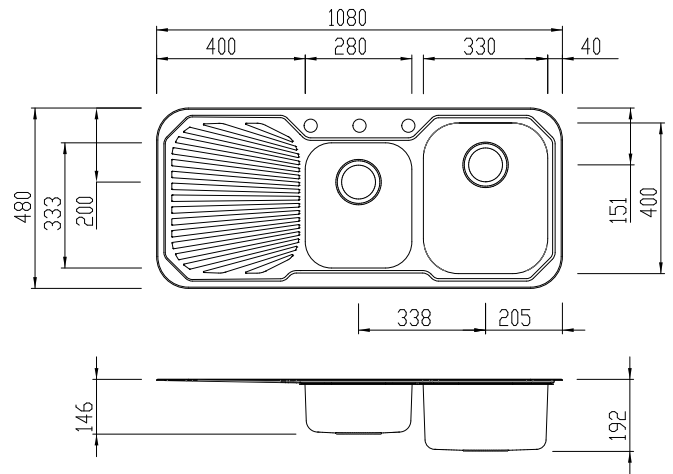

INCLUDED ACCESSORIES

AC14



AC15



AC18

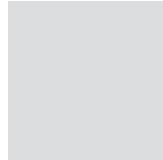
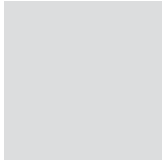
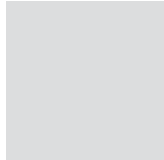

RECOMMENDED TAPWARE

MA4010



PA113/2



OPTIONAL ACCESSORIES

AC03



AC16



AC29

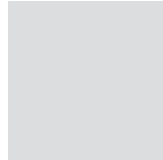
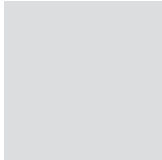
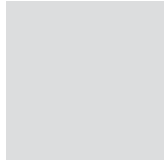
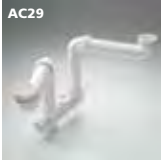

SPECIFICATIONS

Description

1 & 3/4 bowl inset sink with drainer

Sink Size

1080W x 480H

Main Bowl

330W x 400H x 180D / 21L

3/4 Bowl

280W x 330H x 130D / 11L

Construction

2 piece, bowls & drainer seam welded

Material

304 grade, 18/10 polished stainless steel (0.8mm thick)

Installation

Inset recommended.

Fixings

Adjustable clips and sealing foam supplied

Cut Out Template

1060 x 460 x 95mm radius

Min Cabinet Size

700mm

Tap holes

Available 0 to 3 tap hole (specify when ordering)

Waste fittings

2 x 90mm basket wastes included

Overflow

Not available

Carton Size

1090 x 490 x 200mm

Weight

7.5kg

Warranty

Lifetime manufacturer's warranty (refer to oliverisinks.com)

For more information call **1300 13 7465** or visit **www.oliverisinks.com**

